



SPECTRA T950 LIBRARY USER GUIDE



www.SpectraLogic.com

TABLE OF CONTENTS

| | |
|--|----|
| Contacting Spectra Logic | 9 |
| About This Guide | 14 |
| Intended Audience | 14 |
| Product Status | 14 |
| Related Information | 15 |
| Chapter 2 - Library Overview | 17 |
| Library Features | 18 |
| LumOS Software | 18 |
| Front Panel Components | 21 |
| Interior Components | 23 |
| Main and Drive Expansion Frame Rear Components | 24 |
| Operator Panel and Touch Screen | 34 |
| TeraPack Access Ports (TAPs) | 35 |
| Spectra Library Control Modules | 37 |
| Exporting Controllers | 40 |
| Tape Drives | 42 |
| SpectraVision Camera | 43 |
| TeraPack Cartridge Handling | 45 |
| Library Expansion and Upgrades | 46 |
| Overview of the LumOS User Interface | 47 |
| Access Options | 47 |
| LumOS Web Interface | 47 |
| User Interface Features | 48 |
| Logging in to the LumOS User Interface | 50 |
| Dashboard | 51 |
| Overview of the LumOS API | 53 |
| Accessing the LumOS API | 53 |
| Authentication in ReST API | 53 |
| Sample API Command | 54 |
| API Updates | 54 |
| Chapter 3 - Architecture Overview | 55 |
| Media Pools | 56 |
| Library Partitions | 58 |

| | |
|--|----|
| Storage Partitions | 58 |
| Cleaning Partitions and Auto Drive Clean | 59 |
| Drive and Media Frames | 61 |
| Component Identifiers | 63 |
| Drive Identifiers | 64 |
| Connectivity | 65 |
| TeraPorter Connectivity | 65 |
| Drive Connectivity | 68 |
| High-Availability Configurations | 69 |
| Redundant Connectivity | 69 |
| Robotics Failover | 70 |
| Redundant Power Supplies | 70 |
| Chapter 4 - Configuring The Library | 71 |
| Configuring Users | 72 |
| Creating and Editing Users | 73 |
| Editing the Current User Password | 74 |
| Configuring Settings | 75 |
| Basic Settings | 76 |
| Auto-Logout Settings | 77 |
| Authentication Settings | 77 |
| Network Settings | 80 |
| Syslog and Remote Client Settings | 81 |
| Power Settings | 82 |
| Barcode Settings | 83 |
| Dashboard Settings | 84 |
| Partition Overview | 85 |
| Licensing | 85 |
| Configuring and Using Cleaning Partitions and Auto Drive Clean | 85 |
| Configuring and Using Storage Partitions | 86 |
| Storage Partition Options | 86 |
| Creating A Partition | 89 |
| Overview | 89 |
| Partition Interface | 89 |
| Creating A New Cleaning Partition | 90 |
| Creating A New Storage Partition | 91 |

| | |
|---|-----|
| Modifying An Existing Partition | 99 |
| Deleting A Partition | 101 |
| Chapter 5 - Encryption | 102 |
| BlueScale Encryption Key Management Overview | 103 |
| Understanding the Components | 103 |
| Standard Edition vs. Professional Edition | 103 |
| Configuring Encryption | 105 |
| Adding BlueScale Encryption | 105 |
| Exporting BlueScale Encryption Keys | 108 |
| Deleting BlueScale Encryption Keys | 109 |
| Authorization Settings | 110 |
| Multi User Mode | 112 |
| KMIP Encryption Key Management Overview | 114 |
| Adding KMIP Encryption | 114 |
| Chapter 6 - Using The Library | 119 |
| Controlling the Library Power | 121 |
| Power On the Library | 121 |
| Power Off the Library | 122 |
| Importing, Exporting, and Exchanging Magazines | 123 |
| Dual TAP | 123 |
| Bulk TAP | 123 |
| Requirements | 123 |
| Restrictions | 124 |
| Performing an Import or Export | 126 |
| Importing Into a Storage or Cleaning Partition | 127 |
| Import Requirements | 127 |
| Prepare the Storage Partition or the Cleaning Partition | 129 |
| Import the Magazines | 130 |
| Exporting Magazines and Cartridges | 132 |
| Prepare for the Export | 132 |
| Export the Magazines or Cartridges in a Partition | 133 |
| Exchanging Magazines and Cartridges | 135 |
| Prepare for the Exchange | 135 |
| Exchange the Magazines or Cartridges in a Partition | 135 |
| Move Media | 137 |

| | |
|---|------------|
| Moving Media | 137 |
| Media Lifecycle Management | 139 |
| Navigating the MLM Screen | 139 |
| Tape Details | 140 |
| Tape Mount History | 141 |
| Drive Lifecycle Management | 142 |
| Overview | 142 |
| Drive Health Reports | 142 |
| Drive Lifecycle Management | 143 |
| Navigating the DLM Screen | 143 |
| Drive Details | 144 |
| Drive Mount History | 145 |
| Drive Actions | 146 |
| Licenses | 147 |
| Adding a License | 147 |
| Chapter 7 - Maintaining The Library | 148 |
| Updating, Servicing, or Moving the Library | 149 |
| Diagnostics & Utilities | 150 |
| Alerts | 176 |
| Configuring Alerts | 178 |
| Adding or Editing Alert Subscribers | 179 |
| Log Gathering | 181 |
| Gathering Logs | 181 |
| Managing Backups | 182 |
| Package Update | 184 |
| Overview | 184 |
| Configuring a Package Update | 184 |
| Drive Firmware Update | 186 |
| Updating Drive Firmware in LumOS User Interface | 186 |
| Updating Drive Firmware Using ITDT | 192 |
| Robotics | 195 |
| Robot Details | 195 |
| Chapter 8 - Technical Support | 196 |
| Accessing the Technical Support Portal | 197 |

| | |
|---|-----|
| Create an Account | 197 |
| Log Into the Portal | 198 |
| Opening a Support Ticket | 199 |
| Search for Help Online | 199 |
| Submit an Incident Online | 202 |
| Submit an Incident by Phone | 204 |
| Returns | 205 |
| Appendix A - Best Practices | 206 |
| MLM Best Practices | 207 |
| Implementation Guidelines | 207 |
| Usage Policy Guidelines | 208 |
| Using Cartridges | 209 |
| Labeling Cartridges | 209 |
| Handling Cartridges | 210 |
| Storing Cartridges | 211 |
| Using Cartridges in the Library | 212 |
| Cartridge Rotation | 213 |
| Appendix B - Specifications | 217 |
| Library Specifications | 218 |
| Data Storage Capacity | 218 |
| Size and Weight | 221 |
| Service Access Requirements | 223 |
| Shipping and Storage Size and Weight | 223 |
| Power Specifications | 224 |
| Environmental Specifications | 229 |
| Shock and Vibration Specifications | 231 |
| Interface Specifications | 232 |
| Component Interface Connectors | 232 |
| Network Interface Cable Requirements | 232 |
| Universal Serial Bus (USB) Support | 234 |
| NDMP Support | 234 |
| Tape Drive and Media Specifications | 235 |
| LTO Tape Drive Specifications | 235 |
| TS11xx Technology Tape Drive Specifications | 239 |
| Drive-Based Encryption Highlights | 242 |

| | |
|---|-----|
| Tape Media Specifications | 242 |
| Barcode Label Specifications | 246 |
| Interoperability and Software Compatibility | 251 |
| Appendix C - Regulatory & Safety Standards | 252 |
| EU Declaration of Conformity | 253 |
| Emission Standards | 254 |
| FCC Notice | 254 |
| Korean Notice | 254 |
| Safety Standards and Compliance | 255 |
| Laser Warning | 255 |
| Nemko Accreditation | 256 |
| Environmental Regulations | 257 |
| Waste of Electronic and Electrical Equipment (WEEE) Directive | 257 |
| Restriction of Hazardous Substances in Electrical and Electronic Equipment (RoHS) | 257 |
| Measures for the Administration of the Control of Pollution by Electronic Information Products (China) | 258 |
| Recycling Your Library | 258 |
| Conflict Minerals Policy | 259 |

COPYRIGHT

Copyright © 2024-2025 Spectra Logic Corporation. All rights reserved. This item and the information contained herein are the property of Spectra Logic Corporation.

NOTICES

Except as expressly stated herein, Spectra Logic Corporation makes its products and associated documentation on an “AS IS” BASIS, WITHOUT WARRANTY OF ANY KIND, EITHER EXPRESSED OR IMPLIED, INCLUDING BUT NOT LIMITED TO THE IMPLIED WARRANTIES OF MERCHANTABILITY OR FITNESS FOR A PARTICULAR PURPOSE, BOTH OF WHICH ARE EXPRESSLY DISCLAIMED. In no event shall Spectra Logic be liable for any loss of profits, loss of business, loss of use or data, interruption of business, or for indirect, special, incidental or consequential damages of any kind, even if Spectra Logic has been advised of the possibility of such damages arising from any defect or error.

Information furnished in this manual is believed to be accurate and reliable. However, no responsibility is assumed by Spectra Logic for its use. Due to continuing research and development, Spectra Logic may revise this publication from time to time without notice, and reserves the right to change any product specification at any time without notice.

TRADEMARKS

ArcticBlue, BlackPearl, BlueScale, RioBroker, Spectra Cube, Spectra Logic, Spectra Vail, Spectra, SpectraGuard, StorCycle, TeraPack, TFinity, and TranScale are registered trademarks of Spectra Logic Corporation. All rights reserved worldwide. All other trademarks and registered trademarks are the property of their respective owners.

DOCUMENT INFORMATION

Document part number:

- 90940183

Current revision:

- B

Document revision history:

| Revision | Date | Description |
|----------|------------|------------------------|
| A | April 2025 | Initial Release. |
| B | May 2025 | Updated for LumOS 2.2. |

CONTACTING SPECTRA LOGIC

| | |
|--|---|
| To Obtain General Information - Spectra Logic Website: www.spectrallogic.com | |
| United States Headquarters | European Office |
| Spectra Logic Corporation 6285 Lookout Road Boulder, CO 80301 USA | Spectra Logic Europe Ltd. 329 Doncastle Road Bracknell Berks, RG12 8PE United Kingdom |
| Phone: 1.800.833.1132 or 1.303.449.6400 International: 1.303.449.6400 Fax: 1.303.939.8844 | Phone: 44 (0) 870.112.2150 Fax: 44 (0) 870.112.2175 |
| Spectra Logic Technical Support Technical Support Portal: support.spectrallogic.com | |
| United States and Canada - Phone Toll free US and Canada: 1.800.227.4637 International: 1.303.449.0160 | Europe, Middle East, Africa Phone: 44 (0) 870.112.2185 Deutsch Sprechende Kunden Phone: 49 (0) 6028.9796.507 Email: spectrallogic@stortrec.de |
| Mexico, Central and South America, Asia, Australia, and New Zealand Phone: 1.303.449.0160 | |
| Spectra Logic Sales Website: shop.spectrallogic.com | |
| United States and Canada Phone: 1.800.833.1132 or 1.303.449.6400 Fax: 1.303.939.8844 Email: sales@spectrallogic.com | Europe Phone: 44 (0) 870.112.2150 Fax: 44 (0) 870.112.2175 Email: eurosales@spectrallogic.com |
| To Obtain Documents - Spectra Logic Website: support.spectrallogic.com/documentations/documentation | |

END USER LICENSE AGREEMENT

1. READ CAREFULLY

YOU SHOULD READ THE FOLLOWING TERMS AND CONDITIONS BEFORE ACCEPTING THIS END-USER LICENSE AGREEMENT ("EULA"). THIS EULA IS A LEGAL AGREEMENT BETWEEN YOUR ORGANIZATION, THE END USER, AND SPECTRA LOGIC CORPORATION ("SPECTRA") FOR THE SPECTRA SOFTWARE PRODUCT WHICH INCLUDES COMPUTER SOFTWARE AND MAY INCLUDE ASSOCIATED MEDIA, PRINTED MEDIA, AND "ONLINE" OR ELECTRONIC DOCUMENTATION (COLLECTIVELY, "SOFTWARE PRODUCT"). BY INSTALLING, COPYING, OR OTHERWISE USING THE SOFTWARE PRODUCT, YOU AGREE TO BE BOUND BY THE TERMS OF THIS EULA. IF YOU DO NOT AGREE TO THE TERMS OF THIS EULA, YOU MAY NOT INSTALL, COPY, DOWNLOAD OR USE THE SOFTWARE PRODUCT. YOU AGREE THAT YOUR USE OF THE SOFTWARE ACKNOWLEDGES THAT YOU HAVE READ THIS AGREEMENT, UNDERSTAND IT, AND AGREE TO BE BOUND BY ITS TERMS AND CONDITIONS.

2. OWNERSHIP

It is understood and agreed that Spectra Logic Corporation, a Delaware corporation with offices at 6285 Lookout Road, Boulder, CO 80301 ("Licensor") is the owner of all right, title and interest to the Software Product, regardless of the media or form of the original download, whether by the World Wide Web, disk or otherwise. You, as licensee ("Licensee") through your downloading, installing, copying or use of this product do not acquire any ownership rights to the Software Product.

3. GENERAL

The Software Product is licensed, not sold, to you by Spectra for use only under the terms of this EULA. The Software Product is protected by copyright laws and international copyright treaties, as well as other intellectual property laws and treaties. The rights granted herein are limited to Spectra's and its licensors' intellectual property rights in the Software Product and do not include any other patents or intellectual property rights. The terms of this EULA will govern any software upgrades provided by Spectra that replace and/or supplement the original Software Product, unless such upgrade is accompanied by a separate license in which case the terms of that license will govern.

4. SOFTWARE PRODUCT

The Software Product, as used in this EULA, means, collectively and/or as applicable:

- The Software Product package;
- Any and all contents, components, attachments, software, media, and code with which this Agreement is provided and delivered;
- Any and all images, photographs, art, art work, clip art, fonts or other artistic works (the "Art Work");
- Related explanatory written materials and instructions, and any other possible documentation related thereto ("Documentation"); and
- Upgrades, modified versions, updates, additions and copies of the Software Product (the "Upgrades"), if any, licensed to by Spectra under this EULA.

5. GRANT OF LICENSE AND RESTRICTIONS

- A. Spectra grants you a non-exclusive, non-transferable End-User license right to install the Software Product solely for the purpose for which it was created.

-
- B.** Unless provided otherwise in the Documentation or by prior express written consent of Spectra, you shall not display, modify, reproduce and distribute any Art Work, or portion(s) thereof, included with or relating to the Software Product, if any. Any such authorized display, modification, reproduction and distribution shall be in full accord with this EULA. Under no circumstances will your use, display, modification, reproduction and distribution of the Art Work give you any Intellectual Property or Proprietary Rights of the Art Work. All rights, title, and interest belong solely to Spectra.
 - C.** Except for the initial loading of the Software Product, you shall not, without Spectra's express written consent:
 - Copy or reproduce the Software Product; or
 - Modify, adapt, or create derivative works based on the Software Product or any accompanying materials.

6. DESCRIPTION OF OTHER RIGHTS AND LIMITATIONS

- A.** Spectra will provide you with support services related to the Software Product ("Support"). Such Support will be provided in accordance with the Spectra Master Support Agreement, available for download and viewing on the Spectra Corporate Web site. Use of Support is governed by this EULA and Spectra's Master Support Agreement.
- B.** Any supplemental software, code, content, or media provided to you in the course of Support shall be considered part of the Software Product and subject to the terms and conditions of this EULA.
- C.** Spectra retains all right, title, and interest in and to the Software Product, and any rights not granted to you herein are reserved by Spectra. You hereby expressly agree not to extract information, reverse engineer, disassemble, decompile, or translate the Software Product, or otherwise attempt to derive the source code of the Software, except to the extent allowed under any applicable law. In the event that such activities are permitted by applicable law, any information you, or your authorized agent, discover shall be promptly disclosed to Spectra and shall be deemed the confidential information of Spectra.
- D.** You shall not modify, sublicense, assign, or transfer the Software Product or any rights under this EULA, except as expressly provided in this EULA. Any attempt to sublicense, assign, or transfer any of the rights, duties, or obligations will be void.
- E.** You may permanently transfer all of your rights under this EULA, provided you retain no copies. The other party must agree to accept the terms and conditions of the EULA.

7. ALL RESERVED

All rights not expressly granted herein are reserved by Spectra.

8. TERM

- A.** This License is effective until terminated. Licensee may terminate it at any time by destroying the Software Product with all copies, full or partial, and removing all of its component parts.
- B.** Your rights under this EULA will terminate automatically without notice from Spectra if you fail to comply with any term(s) or condition(s) of this EULA. In such event, no notice shall be required by Spectra to effect such termination.
- C.** Upon termination of this EULA, you shall cease all use of the Software Product and destroy all copies, full or partial, together with all backup copies, modifications, printed or written materials, and merged portions in any form and remove all component parts of the Software Product.

9. INTELLECTUAL PROPERTY RIGHTS

- A. Spectra shall retain all right, title, and interest in the Software Product and to any modifications or improvements made thereto, and any upgrades, updates or Documentation provided to End User. End User will not obtain any rights in the Software Product, its updates, upgrades, and Documentation, as a result of its responsibilities hereunder.
- B. End User acknowledges Spectra's exclusive rights in the Software Product and that the Software Product is unique and original to Spectra and that Spectra is owner thereof. Unless otherwise permitted by law, End User shall not, at any time during or after the effective Term of the Agreement, dispute or contest, directly or indirectly, Spectra's exclusive right and title to the Software Product or the validity thereof.

10. U.S. GOVERNMENT END USERS

The Software Product and related documentation are "Commercial Items," as that term is defined at 48 C.F.R. §2.101, consisting of "Commercial Computer Software" and "Commercial Computer Software Documentation," as such terms are used in 48 C.F.R. §12.212 or 48 C.F.R. §§227.7202-1 through 227.7202-4, as applicable. The Commercial Computer Software and Commercial Computer Software Documentation are being licensed to U.S. Government end users (a) only as Commercial Items and (b) with only those rights as are granted to all other End Users pursuant to the terms and conditions herein. Unpublished rights reserved under the copyright laws of the United States.

11. EXPORT LAW ASSURANCES

You may not use or otherwise export or re-export the Software Product except as authorized by United States law and the laws of the jurisdiction in which the Software Product was obtained. In particular, but without limitation, the Software Product may not be exported or re-exported (a) into (or to a nation or resident of) any U.S. embargoed countries or (b) to anyone on the U.S. Treasury Department's list of Specially Designated Nationals or the U.S. Department of Commerce Denied Persons List or Entity List. By installing or using any component of the Software Product, you represent and warrant that you are not located in, under control of, or a national or resident of any such country or on any such list.

12. DISCLAIMER OF WARRANTIES

YOU EXPRESSLY ACKNOWLEDGE AND AGREE THAT USE OF THE SOFTWARE PRODUCT IS AT YOUR SOLE RISK AND THAT THE ENTIRE RISK AS TO SATISFACTORY QUALITY, PERFORMANCE, ACCURACY AND EFFORT IS WITH YOU. TO THE MAXIMUM EXTENT PERMITTED BY APPLICABLE LAW, AND EXCEPT AS MAY BE STATED IN THE SPECTRA MASTER SERVICE AGREEMENT, THE SOFTWARE PRODUCT IS PROVIDED "AS IS," WITH ALL FAULTS AND WITHOUT WARRANTY OF ANY KIND, AND SPECTRA AND SPECTRA'S AFFILIATES (COLLECTIVELY REFERRED TO AS "SPECTRA" FOR THE PURPOSES OF SECTIONS 12 AND 13) HEREBY DISCLAIM ALL WARRANTIES AND CONDITIONS WITH RESPECT TO THE SOFTWARE PRODUCT, EITHER EXPRESS, IMPLIED OR STATUTORY, INCLUDING, BUT NOT LIMITED TO, THE IMPLIED WARRANTIES AND/OR CONDITIONS OF MERCHANTABILITY, OF SATISFACTORY QUALITY, OF FITNESS FOR A PARTICULAR PURPOSE, OF ACCURACY, OF QUIET ENJOYMENT, AND NON-INFRINGEMENT OF THIRD-PARTY RIGHTS. SPECTRA DOES NOT WARRANT AGAINST INTERFERENCE WITH YOUR ENJOYMENT OF THE SOFTWARE PRODUCT THAT THE FUNCTIONS CONTAINED IN THE SOFTWARE PRODUCT WILL MEET YOUR REQUIREMENTS, THAT THE OPERATION OF THE SOFTWARE PRODUCT WILL BE UNINTERRUPTED OR ERROR-FREE, OR THAT DEFECTS IN THE SOFTWARE PRODUCT WILL BE CORRECTED. NO ORAL OR WRITTEN INFORMATION OR ADVICE GIVEN BY SPECTRA OR A SPECTRA AUTHORIZED REPRESENTATIVE SHALL CREATE A WARRANTY. SOME JURISDICTIONS DO NOT ALLOW THE EXCLUSION OF IMPLIED WARRANTIES OR LIMITATION ON APPLICABLE STATUTORY RIGHTS OF A CONSUMER, SO THE ABOVE EXCLUSION AND LIMITATIONS MAY NOT APPLY TO YOU.

13. LIMITATION OF LIABILITY

TO THE MAXIMUM EXTENT PERMITTED BY APPLICABLE LAW, IN NO EVENT SHALL SPECTRA, ITS AFFILIATES OR LICENSEES, BE LIABLE FOR ANY SPECIAL, INCIDENTAL, INDIRECT, OR CONSEQUENTIAL DAMAGES WHATSOEVER (INCLUDING, WITHOUT LIMITATION, DAMAGES FOR LOSS OF BUSINESS PROFITS, BUSINESS INTERRUPTION, LOSS OF BUSINESS INFORMATION, OR ANY OTHER PECUNIARY LOSS) ARISING OUT OF THE USE OF OR INABILITY TO USE THE SOFTWARE PRODUCT OR THE PROVISION OF OR FAILURE TO PROVIDE SUPPORT SERVICES, EVEN IF SPECTRA HAS BEEN ADVISED OF THE POSSIBILITY OF SUCH DAMAGES. IN ANY CASE, SPECTRA'S ENTIRE LIABILITY UNDER ANY PROVISION OF THIS EULA SHALL BE LIMITED TO THE AMOUNT ACTUALLY PAID BY YOU FOR THE SOFTWARE PRODUCT; PROVIDED HOWEVER, IF YOU HAVE ENTERED INTO A MASTER SUPPORT AGREEMENT, SPECTRA'S ENTIRE LIABILITY REGARDING SUPPORT SERVICES SHALL BE GOVERNED BY THE TERMS OF THAT AGREEMENT. BECAUSE SOME STATES AND JURISDICTIONS DO NOT ALLOW THE EXCLUSION OR LIMITATION OF LIABILITY, THE ABOVE LIMITATION MAY NOT APPLY TO YOU.

14. CONTROLLING LAW AND SEVERABILITY

This EULA will be governed by and construed in accordance with the laws of the State of Colorado, as applied to agreements entered into and to be performed entirely within Colorado between Colorado residents. This EULA shall not be governed by the United Nations Convention on Contracts for the International Sale of Goods, the application of which is expressly excluded. If for any reason a court of competent jurisdiction finds any provision, or portion thereof, to be unenforceable, the remainder of this EULA shall continue in full force and effect.

ABOUT THIS GUIDE

This guide describes how to configure, use, maintain, and troubleshoot the Spectra[®] T950 library. It also provides specifications for the library.

INTENDED AUDIENCE

This guide is intended for data center administrators and operators who maintain and operate backup systems. The information in this guide assumes a familiarity with SCSI and Fibre Channel command protocols, as well as with network connectivity protocols such as Fibre Channel, SAS, and Ethernet. It also assumes a knowledge of technical tasks such as configuring operating systems and installing drivers.

PRODUCT STATUS

The Spectra Logic[®] Technical Support portal provides information about which products are currently supported and which are considered discontinued. To view information about discontinued products, log into the portal (see [Accessing the Technical Support Portal](#) on page 197).

RELATED INFORMATION

This section contains information about this document and other documents related to the T950 library.

User Interface Screens

The interface changes as new features are added or other modifications are made between software revisions. Therefore, the screens on your library may differ from those shown in this document.

Additional Publications

For additional information about the T950 library and its drives, refer to the publications listed in this section.

T950 Tape Library

This guide and the following documents related to the T950 library are available as PDF files on the Spectra Logic website at support.spectralogic.com/documentation.

- The [Spectra T950 Library Site Preparation Guide](#) provides information about preparing your site for the installation of the T950 library.
- The [Spectra Tape Libraries SCSI Developer's Guide](#) provides detailed information about the SCSI and Fibre Channel commands used in the library.
- The [Spectra Tape Libraries Warnings](#) document provides all of the warnings found in Spectra tape libraries documentation, in English and 27 other languages.

LTO Ultrium Tape Drives

The following documents provide information that is applicable to all IBM LTO tape drives.

- [*IBM Tape Device Drivers Installation and User's Guide*](#)

Note: This guide also provides information about using the IBM Tape Diagnostic Tool (ITDT) to troubleshoot drive problems.

- [*IBM TotalStorage LTO Ultrium Tape Drive: SCSI Reference*](#)

For drive-specific information, search for the product name (for example, LTO 8) on the documentation page on the IBM website. You can also search the IBM Support Portal at: ibm.com/support/knowledgecenter/.

TS11xx Technology Drives

The following documents provide information that is applicable to TS11xx technology drives.

- [*IBM System Storage Tape Drive 3592 SCSI Reference*](#)
- [*IBM Tape Device Drivers Installation and User's Guide*](#)

Note: This guide also provides information about using the IBM Tape Diagnostic Tool (ITDT) to troubleshoot drive problems.

Typographical Conventions

This document uses the following conventions to highlight important information:



WARNING

Read text marked by the "Warning" icon for information you must know to avoid personal injury.



CAUTION

Read text marked by the "Caution" icon for information you must know to avoid damaging the library, the tape drives, or losing data.



IMPORTANT

Read text marked by the "Important" icon for information that helps you complete a procedure or avoid extra steps.

Note: Read text marked with "Note" for additional information or suggestions about the current topic.

CHAPTER 2 - LIBRARY OVERVIEW

The Spectra T950 library is an enterprise-class, highly scalable library. It provides fast, affordable storage that meets the stringent requirements for data integrity, data security, and high reliability in the enterprise environment.

This chapter provides an overview of the T950 library features and components.

| | |
|--|-----------|
| Library Features | 18 |
| LumOS Software | 18 |
| Front Panel Components | 21 |
| Interior Components | 23 |
| Main and Drive Expansion Frame Rear Components | 24 |
| Operator Panel and Touch Screen | 34 |
| TeraPack Access Ports (TAPs) | 35 |
| Spectra Library Control Modules | 37 |
| Exporting Controllers | 40 |
| Tape Drives | 42 |
| SpectraVision Camera | 43 |
| TeraPack Cartridge Handling | 45 |
| Library Expansion and Upgrades | 46 |
| Overview of the LumOS User Interface | 47 |
| Access Options | 47 |
| LumOS Web Interface | 47 |
| User Interface Features | 48 |
| Logging in to the LumOS User Interface | 50 |
| Dashboard | 51 |
| Overview of the LumOS API | 53 |
| Accessing the LumOS API | 53 |
| Authentication in ReST API | 53 |
| Sample API Command | 54 |
| API Updates | 54 |

LIBRARY FEATURES

This section provides an overview of the features that make the T950 library a highly versatile enterprise storage solution. The library's unique modular design lets you tailor the library to suit your current data requirements and easily expand it in the future. Keep up with data growth and technology changes by adding storage capacity and incorporating new drive technologies as they become available.

LumOS Software

The library's LumOS software lets you set configuration options, view library and drive information and metrics, manage cartridges, and monitor library operations. You can access the LumOS interface using any of the following methods:

- The T950 operator panel interface — via the touch screen on the library's operator panel.
- The LumOS web interface — via the Remote Library Controller (RLC) using a standard web browser.
- The LumOS API — via API Platform software or a custom program developed to use the LumOS API.

See [Overview of the LumOS User Interface on page 47](#), for detailed information about the features and controls provided by the LumOS user interface.



IMPORTANT

Many of the features described in this user guide require your library to be running the most current version of the LumOS software. Spectra Logic recommends that you keep your library's LumOS software and component firmware up-to-date at all times. If you are using a previously released LumOS package, upgrading to the current release is strongly recommended. See [Maintaining The Library on page 148](#) for detailed information.

The LumOS software includes the following features (listed in alphabetical order).

API Command Interface

The API interface provides a set of commands for use in customer-generated programs used for controlling all library operations without using the LumOS user interface.

Auto Configuration Save

The Auto Configuration Save feature automatically generates a daily backup file on the LS. The backup file contains the library configuration, partition configuration, move history, and the MLM and DLM databases, as well as the encryption configuration and any BlueScale encryption keys.

If desired, you can download the backup file after it is created. Having an external copy of the backup file ensures that you can recover the library configuration, as well as the MLM and DLM databases, in the event of a disaster and is highly recommended.

Auto Drive Clean

Auto Drive Clean provides library-based cleaning of drives without user intervention. Automated drive cleaning results in fewer failed tape read/write operations and is the recommended method for cleaning drives.

The Auto Drive Clean feature uses a dedicated cleaning partition for storing cleaning cartridges. The cleaning partition can be shared by multiple storage partitions and is used by the library to automatically clean drives whenever necessary.

Diagnostics and Utilities

Diagnostics and utilities are available through the LumOS interface. Selecting a diagnostic or utility displays additional information, including whether or not you can run the operation while the library is operating.

**IMPORTANT**

In general, the library diagnostics and advanced utilities are only for use under the direction of Spectra Logic Technical Support.

Drive Lifecycle Management

Drive Lifecycle Management (DLM) helps you identify drives that are experiencing high error rates or other problems. See [Drive Lifecycle Management on page 142](#) for detailed information.

Encryption Key Management

The Spectra T950 library can encrypt data and manage encryption keys using BlueScale key management.

EnergyAudit Reporting

The EnergyAudit feature lets you gather power consumption metrics using the LumOS API.

Media Lifecycle Management

Media Lifecycle Management (MLM) helps you manage your tape media by giving you tools to proactively determine potential media errors before they happen. See [Media Lifecycle Management on page 139](#) for detailed information about configuring and using the MLM features.

Shared Library Services (SLS) Partitioning

The library uses Shared Library Services (SLS) virtualization technology to partition the library into multiple virtual libraries. See [Library Partitions](#) for detailed information about how partitions function in the library. See [Creating A Partition on page 89](#) for detailed information about configuring and using partitions.

Soft Load

The Soft Load feature uses the drives soft load (or auto load) functionality to improve library performance. Soft Load requires that the partition use LTO-6 or later generation drives.

Spectra Swarm

The Spectra Swarm bridge is a high-performance storage controller that adds 40-Gigabit Ethernet connectivity to SAS tape drives. See the [*Spectra Swarm Bridge Installation & Configuration Guide*](#) for more information.

Front Panel Components

Figure 1 shows the front components of a five frame library. It also shows the relative locations of the main frame, the expansion frames, and the service frames. The expansion frames and bulk TAP are optional.

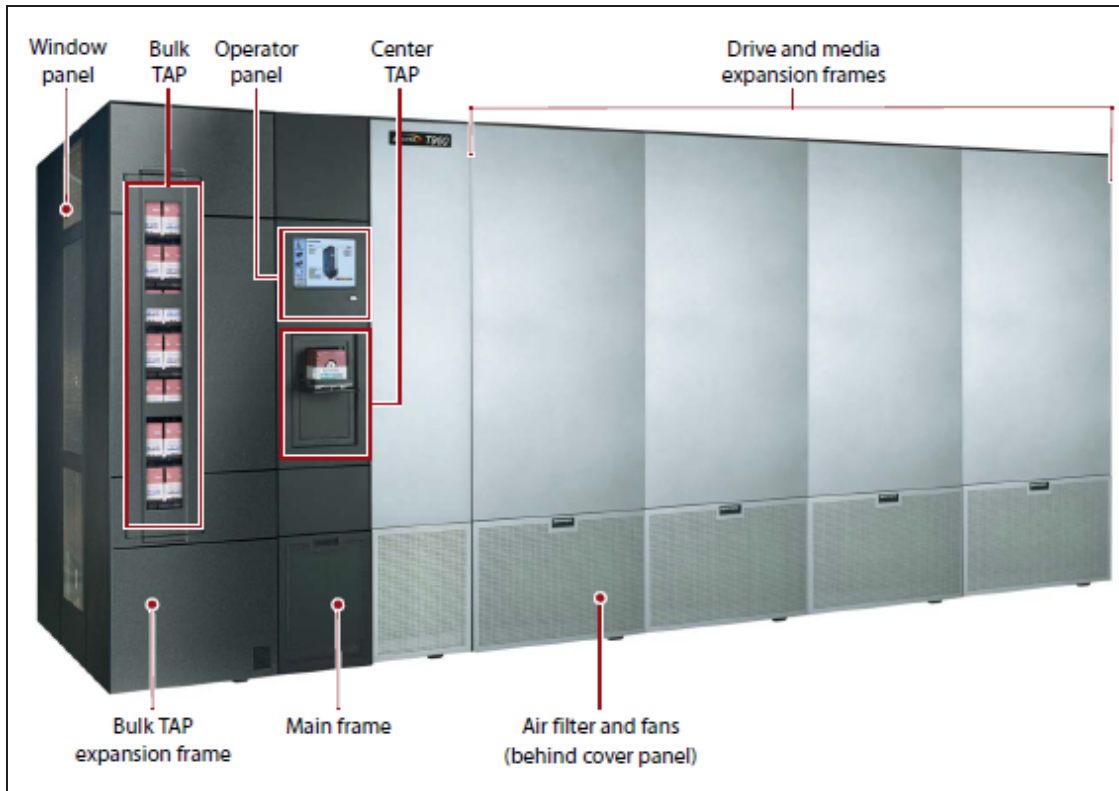

Figure 1 Front panel components.

The following table describes each of the components shown in Figure 1.

| Component | Description |
|----------------------|---|
| Window Panels | The window panels on the outer side of the right- and left-most frames let you view the inside of the library and provide access to the interior components. The window panels are equipped with safety interlocks that power down the library robotics when removed. |
| Main Frame | The main frame houses the library control module (LCM), the main robotics control module (RCM), the operator panel, the TeraPack access port (TAP), robotics interface modules (RIMs), power supplies, the EtherLib switch, and drives. It also provides cartridge storage. |

| Component | Description |
|-------------------------------------|--|
| Operator Panel | The operator panel on the main frame includes a color LCD touch screen and library power button. To learn more, see Operator Panel and Touch Screen on page 34 . A stylus for making selections and typing entries on the touch screen can be conveniently stored near the screen. |
| TeraPack Access Ports (TAPs) | <p>The TeraPack Access Ports (TAPs) act as entry/exit ports that let you import media into or remove media from the library. The library has two types of TAPs:</p> <ul style="list-style-type: none"> • The center TAP lets you import or export a single magazine. The two TAP chambers alternate to provide increased throughput. • The optional bulk TAP lets you import or export up to 14 TeraPack magazines in a single operation. <p>To learn more about the TAP, see TeraPack Access Ports (TAPs) on page 35.</p> |
| Expansion Frames | Expansion frames make it possible to increase media storage capacity or the number of drives in the library. See Drive, Media, and Service Frames for more information. |
| Air Filters and Fans | The air filters on the front of the main frame, drive frames, and service frames prevent particulate contaminants from being pulled into the library by the air circulation system. Redundant fans in the main and drive frames ensure positive pressure inside the library, keeping dust out, and circulate clean air for climate control inside the library. |
| Doors (not shown) | Lockable doors on the back of the main, drive expansion, and service frames enclose the drives and cable connections to prevent unauthorized access. |

Interior Components

Figure 2 shows the interior components of the library.

Note: The interior components are shown for reference only. They are not accessible during normal operation.

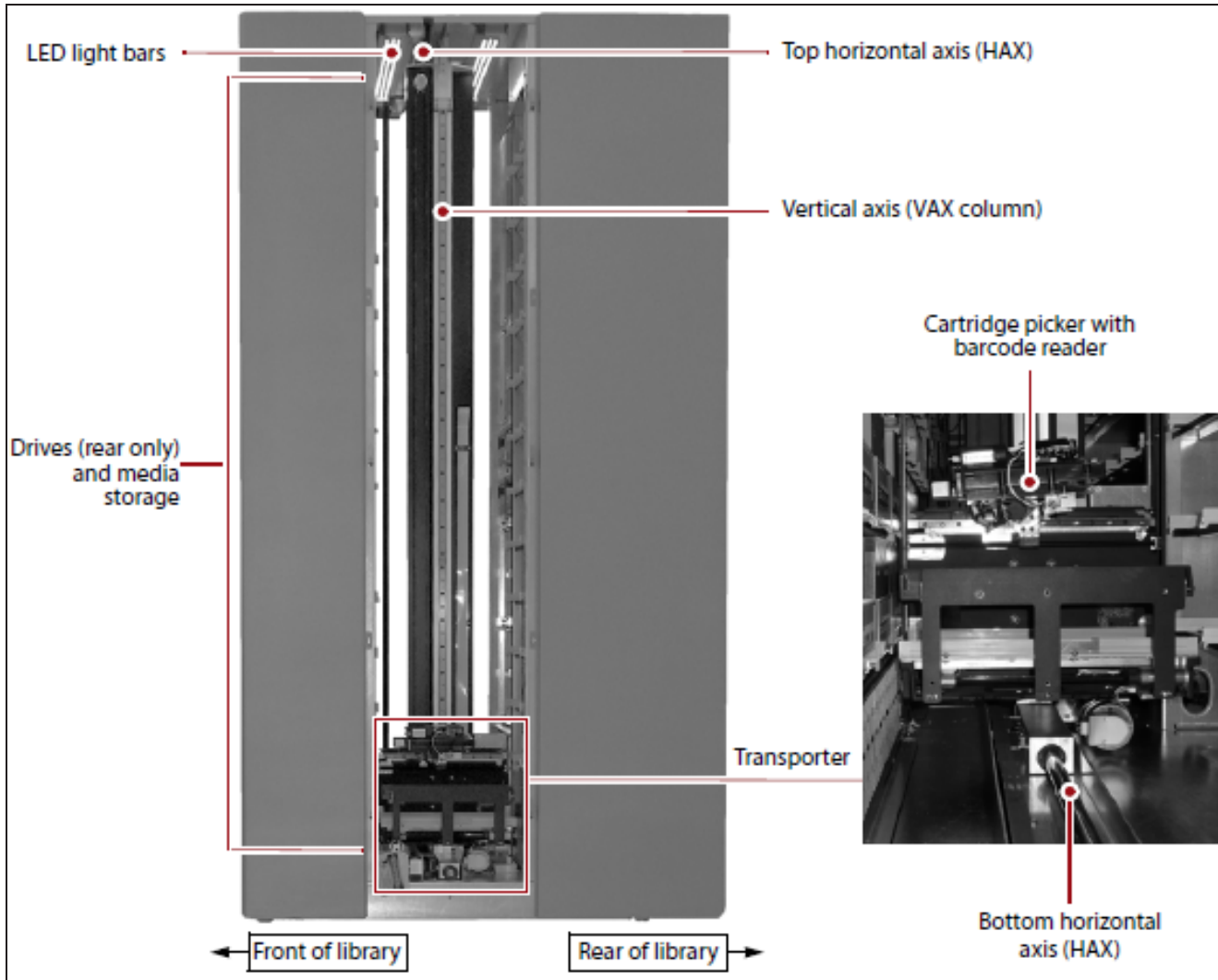

Figure 2 Library interior components (viewed through the right-hand service frame with the access panel removed).

The following table describes each of the components shown in Figure 2.

| Component | Description |
|-----------------------|--|
| LED Light Bars | The LED light bars, mounted at the top of the main frame and each expansion frame, illuminate the interior of the library. |

| Component | Description |
|-----------------------------|---|
| | <p>Note: Depending on your library, the light bars may be different from those shown in Figure 2 on page 23.</p> |
| <p>Transporter</p> | <p>The transporter and the Vertical Axis (VAX) column make up the robotics used to move a TeraPack magazine from one location to another in the library.</p> <p>The transporter, which is mounted on the VAX column, retrieves the magazine from the source chamber and holds it while the VAX column moves to its destination. The cartridge picker then removes the requested individual cartridge from the magazine and inserts it into a drive. When the drive is finished using the cartridge and ejects it, the cartridge picker retrieves the cartridge and places it in a magazine. The VAX column then moves the transporter to return the magazine to a storage chamber.</p> <p>The VAX column moves along the horizontal axis (HAX) and the transporter moves up and down the VAX column to perform all media movement within the library. The barcode reader mounted on the cartridge picker reads the barcode labels on TeraPack magazines and individual cartridges. The library uses the barcode label information to maintain an inventory of the media currently stored inside the library.</p> |
| <p>Media Storage</p> | <p>All of the media in the library is stored in TeraPack magazines. Each magazine contains nine slots for TS11xx technology cartridges or ten slots for LTO cartridges. The magazines are placed in TBAs or on shelves divided into chambers. Each chamber provides storage for one TeraPack magazine.</p> <p>The number of slots in a frame depends on the type and configuration of the frame and magazines (see <i>Drive, Media, and Service Frames</i>). The maximum media storage capacity of the library depends on the number of drives installed and the number of drive and media expansion frames installed (see <i>Data Storage Capacity</i>).</p> |

Main and Drive Expansion Frame Rear Components

The components on the library’s rear panel depend on the type of frame. Figure 3 shows the rear panel components of the library main frame. Except where noted in the following descriptions, the same components are present in each drive expansion frame.

Note: Any bays that do not contain components must have covers installed to maintain proper air circulation throughout the library and to protect the internal components.

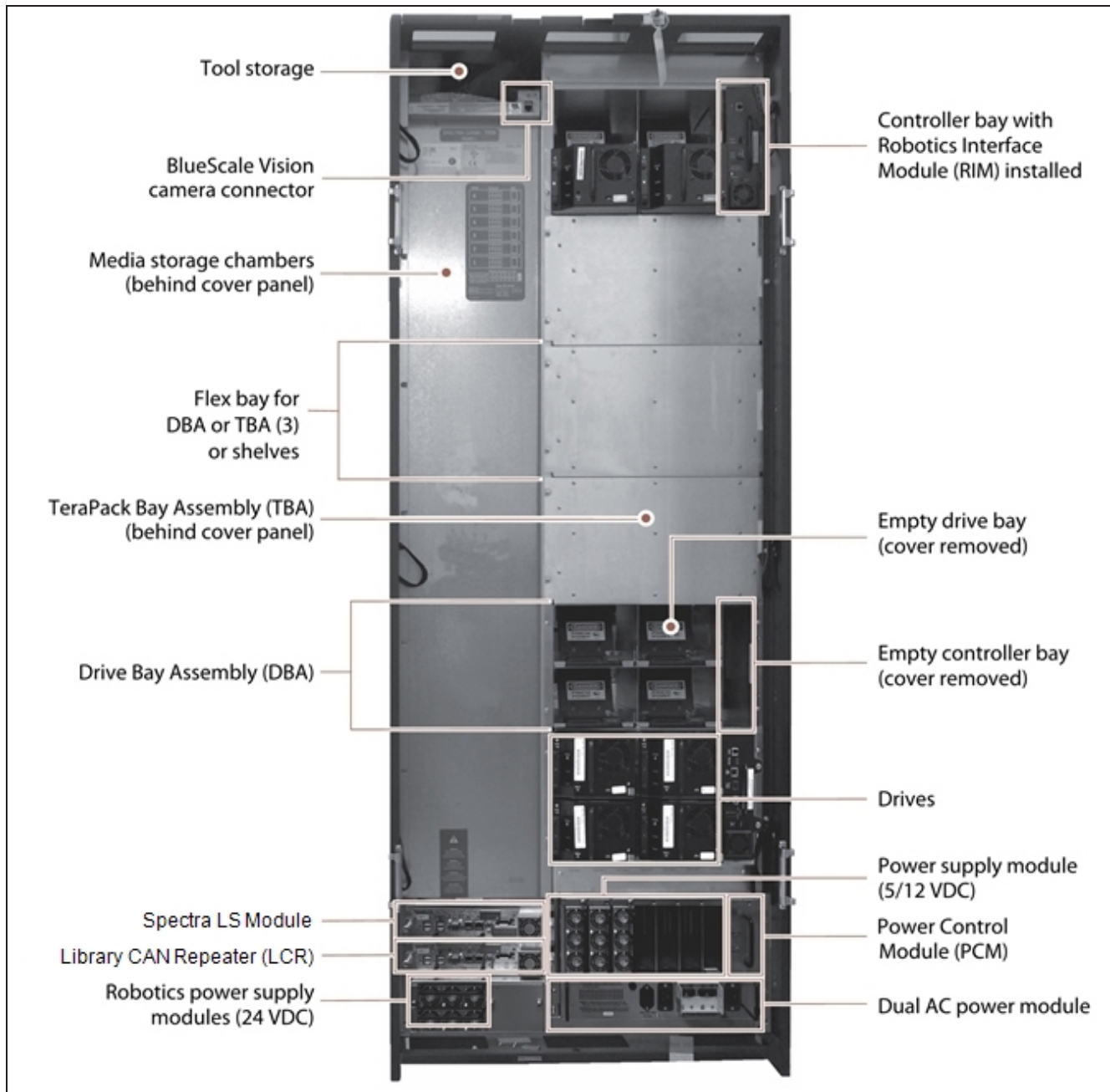
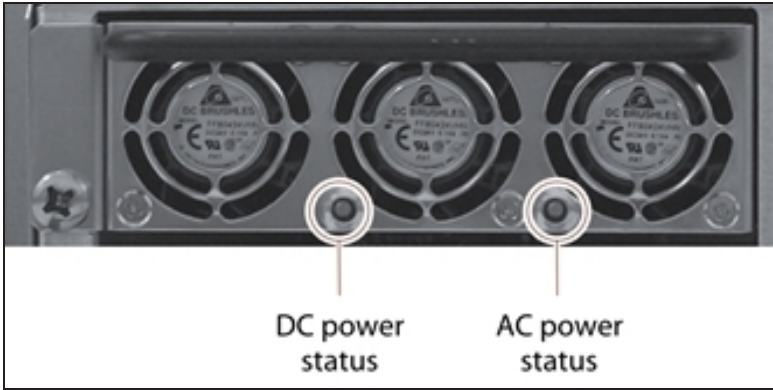

Figure 3 Library main frame rear components (doors removed).

The following table describes each of the components shown in Figure 3 on page 25.

| Component | Description |
|--------------------------|--|
| Doors (not shown) | Doors on the back of each frame protect the cabling connections. The doors are equipped with safety interlocks that cause the library robotics to operate at a reduced speed while the doors are open. |

| Component | Description |
|--|---|
| Tool Storage | The compartment above the media storage area in the main frame provides space for storing the tool kit and documentation that accompanies the library. |
| BlueScale Vision Camera Connector | <p>The dedicated Ethernet port for the BlueScale Vision camera lets you connect the camera to an Ethernet network and use the web-based software to monitor the interior of the library. Each frame that contains a camera has an Ethernet connector.</p> <p>Notes:</p> <ul style="list-style-type: none"> • The BlueScale Vision camera connector is not present if a frame does not have a BlueScale Vision camera installed. • In media expansion frames, the connector is in a similar location. |
| Media Storage Chambers | All of the media in the library is stored in TeraPack magazines, each of which contains ten slots for LTO media or nine slots for TS11xx technology media. The magazines are placed on shelves divided into chambers. The number of chambers at the back of a frame depends on the type of frame and its configuration. |
| Drive Bay Assemblies (DBAs) | <p>A main or drive frame can have either three or six DBAs installed. Each DBA provides the electrical and internal interface connections for up to four drives. Each DBA also includes a controller bay for a RIM or EtherLib switch to the right of the drives.</p> <p>Notes:</p> <ul style="list-style-type: none"> • Any drive or controller bays that do not contain components must have covers installed to maintain proper air circulation throughout the library and to protect internal components. • The library does not support placing an LTO drive in Drive Bay Assembly position 1 if there is a TS11xx technology drive in Drive Bay Assembly position 2, or in Drive Bay Assembly position 3 if there is a TS11xx technology drive in Drive Bay Assembly position 4. |
| Flex Bays (for DBAs or TBAs) | <p>In LTO main and drive frames, three flex bays make it possible to configure the frame to increase media storage capacity or data throughput. The flex bays accommodate either three Drive Bay Assemblies (DBAs) or three TeraPack Bay Assemblies (TBAs).</p> <p>Note: TS11xx technology or mixed media main and drive frames always include DBAs or shelves in place of the flex bays.</p> |
| TeraPack Bay Assemblies (TBAs) | Each TBA contains four chambers, each of which accommodates a single magazine. If the frame has only three DBAs installed, TBAs occupy the flex bays. |

| Component | Description |
|--|---|
| <p>LCM</p> | <p>Dedicated on-board library control modules run the LumOS software that controls all aspects of library operation.</p> |
| <p>24 VDC Robotics Power Supply Modules</p> | <p>Two 24 VDC power supply modules in the main frame provide redundant power for the library robotics and motors, the fans, and the interior LED light bars.</p>  <p>Each 24 VDC power supply module has two indicator LEDs, one for DC power status and one for AC power status. The color of the LED indicates the power supply status:</p> <ul style="list-style-type: none"> • Green — The power is on and functioning normally. • Orange — The power supply has a fault condition. • Off — The power is not on or the power supply module is not functioning normally. <p>Notes:</p> <ul style="list-style-type: none"> • Drive expansion frames do not include 24 VDC power supply modules. • If the second 24 VDC power supply module is not installed, a cover over the opening maintains proper air circulation throughout the frame. |
| <p>Robotics Interface Module (RIM)</p> | <p>One RIM2 can be installed in each of the vertical controller bays to the right of the drives in the main frame DBA (see Figure 3 on page 25). A RIM2 or LTO-6 or later generation drive, or a TS tape technology drive is required to provide the Fibre Channel interface to the library's TeraPorter.</p> |
| <p>Drives</p> | <p>The library accommodates multiple generations of high-performance, high-capacity, full-height and half-height LTO drives, TS11xx technology drives. The drives are installed in DBAs, with each DBA accommodating up to four drives. Drives are hot-swappable to provide uninterrupted operation.</p> <p>Notes:</p> <ul style="list-style-type: none"> • Any drive bays that do not have drives installed must have covers installed to maintain proper air circulation throughout the frame and to protect internal library components. |

| Component | Description |
|---|--|
| | <ul style="list-style-type: none"> The library does not support placing an LTO drive in Drive Bay Assembly position 1 if there is a TS11xx technology in Drive Bay Assembly position 2, or in Drive Bay Assembly position 3 if there is a TS11xx technology in Drive Bay Assembly position 4. |
| Power Control Module (PCM) | <p>The PCM supplies power to the power supplies and monitors the power supply modules in the frame for output voltage, output current, power supply fan operational status, and power supply operational temperature. The PCM uses the voltage and current data to calculate the library power usage that is available using the API and displayed in the LumOS user interface.</p> |
| 5/12 VDC Power Supply Modules | <p>The 5/12 VDC power supply modules convert AC input to provide the 5 VDC and 12 VDC power used by the drives in the frame. In the main frame, these power supplies also provide power to the controller bays, the LCM, the RCM, and the LCD operator panel. With the exception of its voltage rating, the 5/12 VDC power supply module physically resembles the 24 VDC robotics power supply module shown on the previous page.</p> <p>The number of supplies required by a library is calculated by Spectra Logic based on the number and type of drives in the library. Extra supplies provide redundancy and failover protection.</p> <p>There are two different power supplies available depending on the age and configuration of the library. The new and old supplies can be mixed in a power control module and older supplies can always be replaced by a newer supply. However, newer supplies cannot always be replaced by an older supply. Contact Spectra Logic Technical Support (see Technical Support on page 196) for more information.</p> |
| 5/12 VDC Power Supply Modules (continued) | <p>Power Supply Type 1</p> <p>Each power supply module has two indicator LEDs, one for AC power status and one for DC power status. The color of the LED indicates the status.</p> <ul style="list-style-type: none"> Green — The power is on and functioning normally. Orange — The power supply has a fault condition. Off — The power is not on or the power supply module is not functioning normally. <p>Note: Any bays that do not have power supply modules installed must have covers installed to maintain proper air circulation throughout the frame.</p> |

| Component | Description |
|--|--|
| | <div data-bbox="485 268 1437 655" data-label="Image"> <p>The image shows a row of seven power supply modules. On the far right is a Power Control Module (PCM). Labels point to 'DC power status' and 'AC power status' LEDs on the first module, 'Power supply modules' for the row, 'Power Control Module (PCM)' for the rightmost unit, and 'Reset button' on the PCM.</p> </div> <p data-bbox="451 684 743 716">Power Supply Type 2</p> <p data-bbox="451 720 1443 821">Each power supply module has three indicator LEDs, one for AC power status, one for 5-volt power status, and one for 12-volt power status. The color of the LED indicates the status.</p> <ul data-bbox="451 842 1430 1050" style="list-style-type: none"> • Green — The power is on and functioning normally. • Amber — The supply is operating with a Current/Temperature Limit. • Red — There is a fault that prevents the supply from operating. • Off — The power is not on or the power supply module is not functioning normally. <p data-bbox="451 1060 1422 1127">Note: Any bays that do not have power supply modules installed must have covers installed to maintain proper air circulation throughout the frame.</p> <div data-bbox="485 1148 1437 1522" data-label="Image"> <p>This image is similar to the one above but shows the status LEDs on the first module illuminated. Labels point to 'Status LEDs' on the first module, 'Power supply modules' for the row, 'Power Control Module (PCM)' for the rightmost unit, and 'Reset button' on the PCM.</p> </div> |
| <p data-bbox="167 1566 373 1629">Dual AC Power Module</p> | <p data-bbox="451 1562 1451 1738">The dual AC power module provides surge protection for the library power system and monitors the primary AC input power to determine whether it is present and of adequate voltage. If the primary AC input fails or drops too low, the dual AC power module handles the failover to the redundant, secondary AC input until the primary input is restored.</p> |

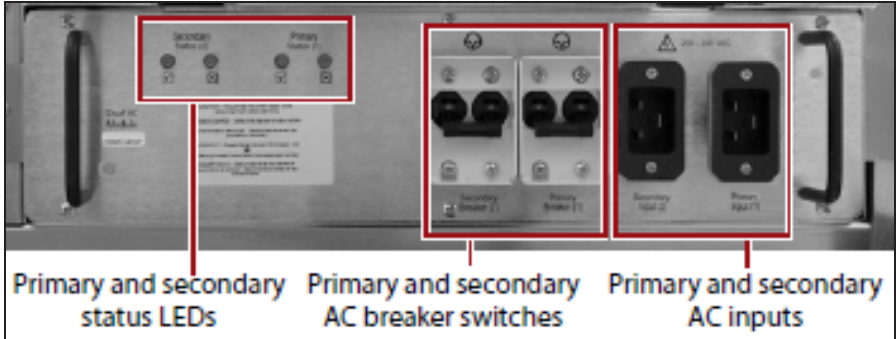
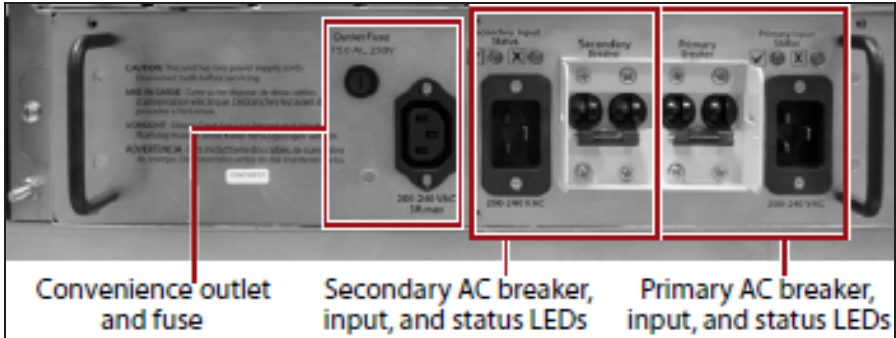
| Component | Description |
|--|---|
| | <p>Each dual AC power module includes both primary and secondary AC power connectors and two breaker switches. There are three types of dual AC power modules: dual AC, dual AC with convenience outlet, and dual AC 2. Dual AC with convenience outlet and dual AC 2 power modules include a 200-240 VAC convenience outlet. The dual AC convenience outlet is rated at 5 A. The dual AC 2 convenience outlet is rated at 2 A.</p> <p>Dual AC Power Module and Dual AC Power Module with Convenience Outlet</p> <p>LEDs indicate the status of the primary and secondary AC inputs.</p> <ul style="list-style-type: none"> • Primary and Secondary Input Power LED States: <ul style="list-style-type: none"> • Green - Good/Active • Orange - Under Voltage <p>CAUTION If the power sources for the AC inputs for a frame using the dual AC or dual AC with convenience outlets are not on the same phase, damage to the library could result.</p>  <p>Figure 4 Dual AC power module</p>  <p>Figure 5 Dual AC power module with convenience outlet</p> |
| <p>Dual AC Power Module (continued)</p> | <p>Dual AC 2 Power Module</p> <p>LEDs indicate the status of the primary and secondary AC inputs and the overall dual AC 2 module.</p> |

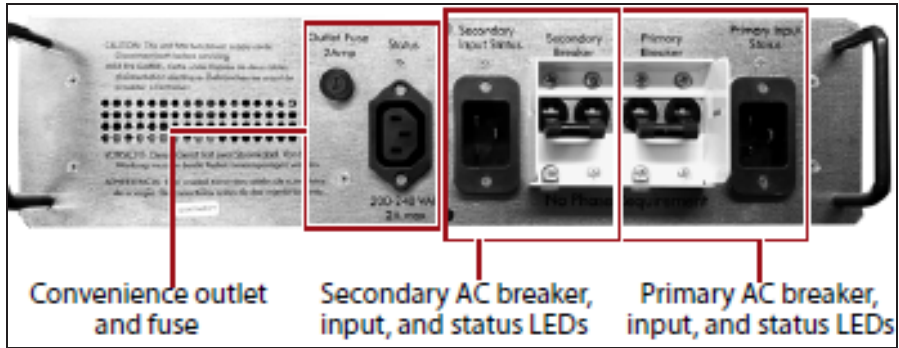
| Component | Description |
|-----------|---|
| | <ul style="list-style-type: none"> • Primary and Secondary Input Power LED States: <ul style="list-style-type: none"> • Green - Good/Active • Blue - Good/Not Active • Orange - Bad/Active, cannot switch to secondary source • Red - Under Voltage Lockout • Off - Not Present • Dual AC 2 Status LED States: <ul style="list-style-type: none"> • Blinking Green - Good Status • Solid Red - Over Temperature, >100C <p>Notes:</p> <ul style="list-style-type: none"> • The dual AC 2 does not require the power sources for the AC inputs for a frame to be on the same phase. • The convenience outlet is powered by the primary AC input. If the primary input fails, the convenience outlet does not function. <div style="text-align: center;">  <p data-bbox="540 1171 781 1234">Convenience outlet and fuse</p> <p data-bbox="829 1171 1105 1234">Secondary AC breaker, input, and status LEDs</p> <p data-bbox="1138 1171 1406 1234">Primary AC breaker, input, and status LEDs</p> </div> <p>Figure 6 Dual AC 2 power module.</p> |

Bulk TAP Media Expansion Frame Components

The bulk TeraPack Access Port (TAP) media expansion frame is used to import or export up to 14 magazines in a single operation. See TeraPack Access Ports (TAPs) on page 35 for detailed information about how the bulk TAP operates.

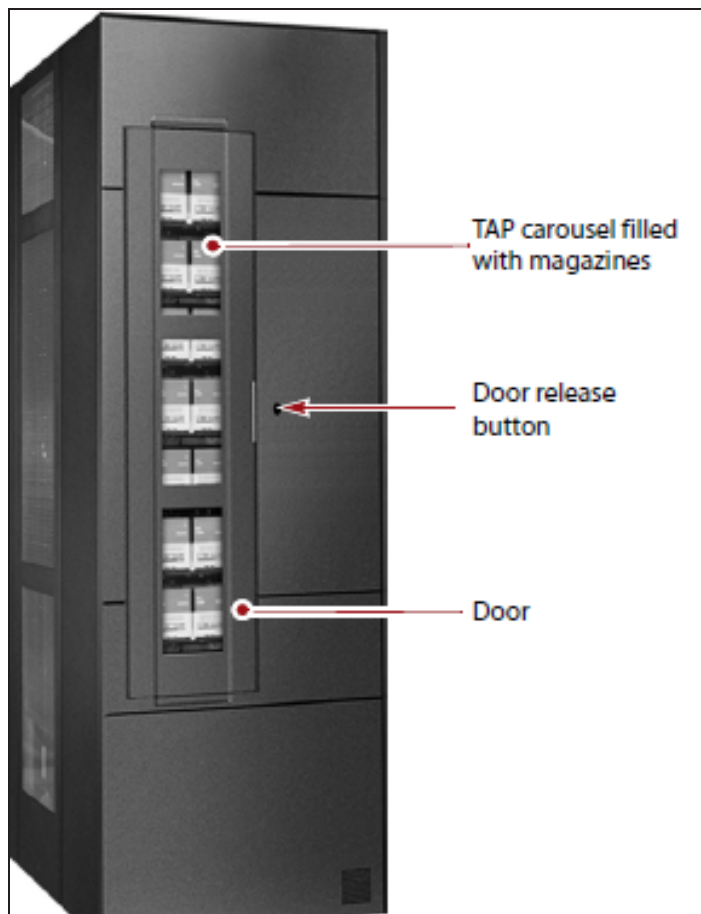

Figure 7 The front of the bulk TAP service frame.

The following table describes each of the components shown in Figure 7.

| Component | Description |
|----------------------------|---|
| TAP Carousel | The TAP carousel accommodates up to 14 TeraPack magazines. |
| Door Release Button | <p>An LED in the button indicates the current state of the TAP carousel. Pressing the button, when the carousel is ready to be loaded or unloaded, opens the door.</p> <ul style="list-style-type: none"> • Solid green — The carousel is ready to be loaded or unloaded. • Flashing green — An import or export operation is in progress. • Red — The carousel is in an error state. • Off — The carousel is empty and there are no unprocessed import or export requests. |
| Door | The door locks to prevent unauthorized access to the carousel. |

| Component | Description |
|--|--|
| Media Storage | The bulk TAP frame has 50 LTO media storage chambers or 42 TS11xx media storage chambers. Each chamber accommodates a single TeraPack magazine. See Drive, Media, and Service Frames for additional information. |
| Bulk TAP Service Control Module (SCM) (on rear) | The bulk TAP service control module (SCM) provides the control logic for the bulk TAP carousel and door. |

Operator Panel and Touch Screen

The operator panel touch screen on the main frame provides local access to the LumOS user interface through the Library Control (LC) server. You can select options and enter information by touching the appropriate location on the screen.

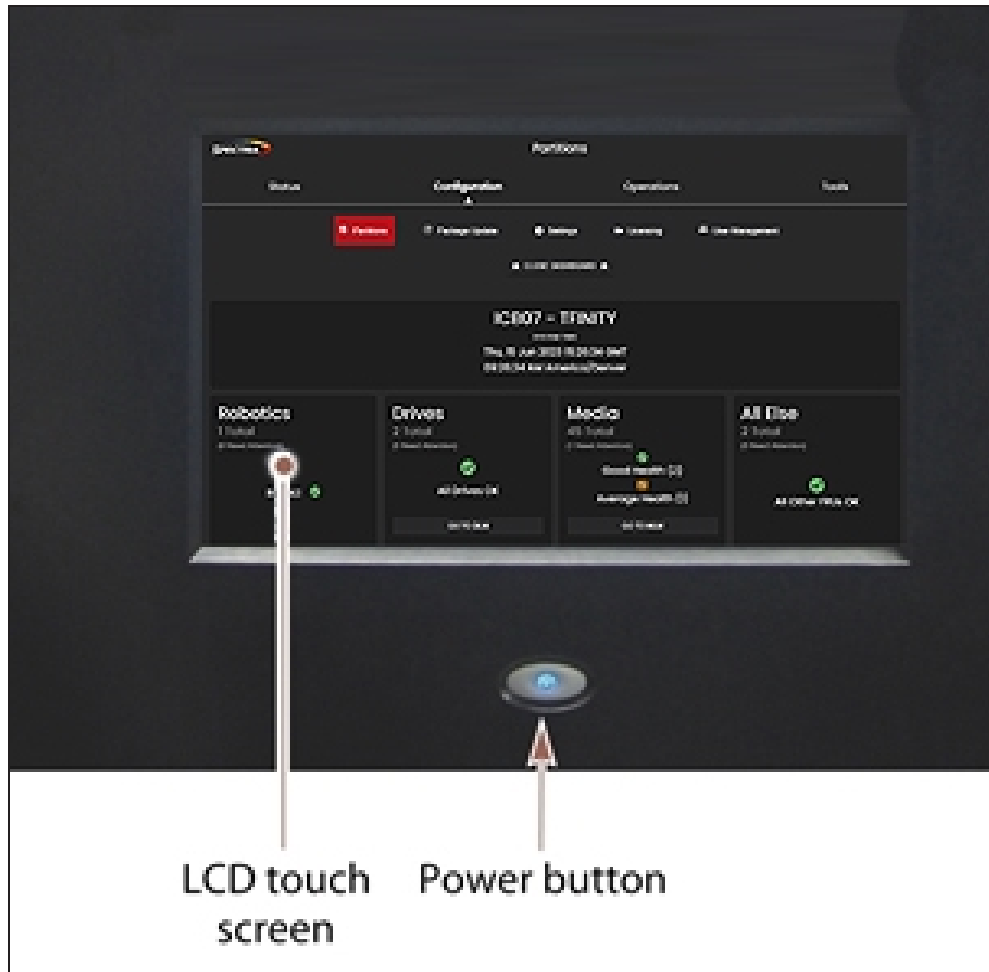

Figure 8 The library operator panel displaying the Dashboard screen of the LumOS user interface.

The operator panel includes the following features:

| Component | Description |
|-------------------------|---|
| LCD touch screen | The LCD touch screen lets you monitor library operations and select configuration options using the LumOS user interface. |
| Power Button | The power button provides front panel on/off control of the library. |

TeraPack Access Ports (TAPs)

The TeraPack Access Ports (TAPs) act as entry/exit ports that let you import magazines into or export magazines from the library. A magazine can contain one or more cartridges or it can be empty.

Note: To import or export individual cartridges, they must be placed in a magazine.

The library features two types of TAPs:

- The center TAP lets you move TeraPack magazines into or out of the library one at a time. During import or export operations involving multiple magazines, the TAP doors alternate so that the operation completes more quickly.
- The carousel in the bulk TAP media frame lets you move up to 14 magazines into or out of the library in a single operation.

Using the TAP to move cartridges into and out of the library provides these key advantages:

- **Data Security** — Media is never stored in the TAP. A newly inserted TeraPack magazine is automatically moved into the library and placed in a storage chamber. A magazine already in the library is only moved to the TAP when you request an export operation through the user interface. Data security and backup integrity are enhanced because the media stored in the library can only be accessed using the password-protected LumOS user interface or API.
- **Convenience** — Instead of individually importing or exporting single cartridges as you would with a traditional entry/exit port, using a TAP lets you handle multiple cartridges in a single operation, thus reducing the time spent on import and export tasks.

Center TAP

The center TAP lets you move a single TeraPack magazine into and out of the library. When you use the center TAP, one of the two TAP doors opens so that you can insert or remove a magazine. During import or export operations involving multiple magazines, the TAP doors can alternate so that the operation completes more quickly.

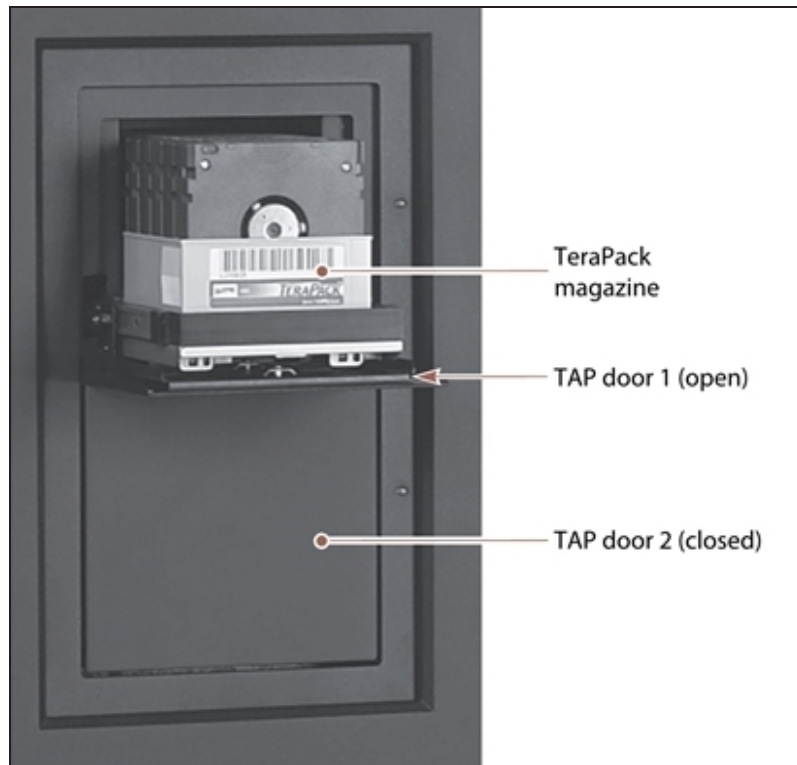

Figure 9 The center TAP with a TeraPack magazine loaded.

See [Importing, Exporting, and Exchanging Magazines](#) on page 123 for details on how the center TAP is used to import and export TeraPack magazines.

Bulk TAP

The optional bulk TAP service frame lets you import or export up to 14 TeraPack magazines in a single operation.

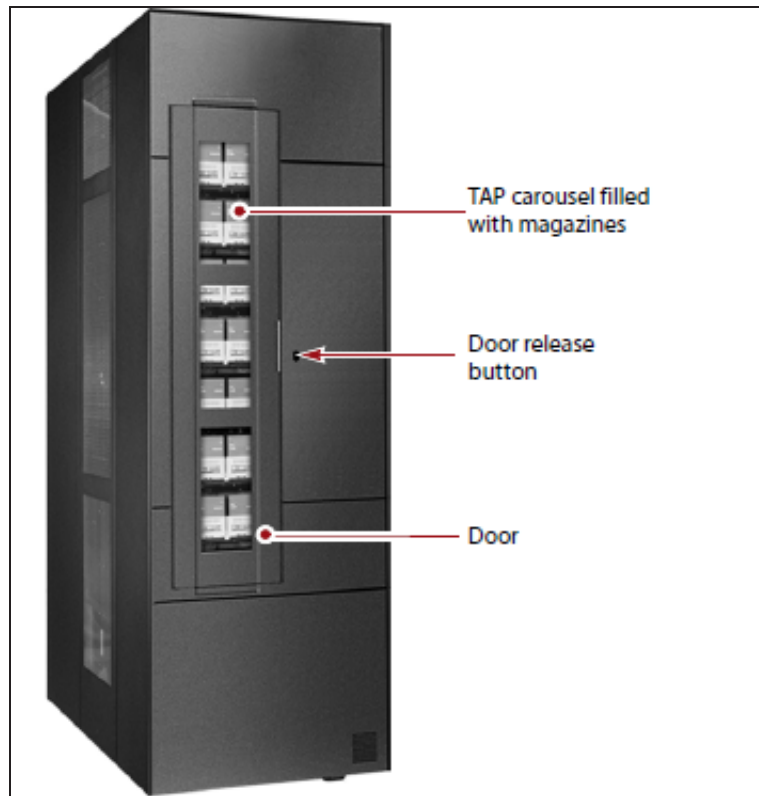

Figure 10 The bulk TAP carousel.

See [Importing, Exporting, and Exchanging Magazines](#) on page 123 for details on how the bulk TAP is used to import and export TeraPack magazines.

Spectra Library Control Modules

The library uses control modules called the Spectra Library Server (Spectra LS). The dedicated computer run the library's LumOS software, which controls and manages all aspects of the library operation. It functions as both the Library Control Module (LCM) and the Robotics Control Module (RCM).

Spectra LS Overview

Figure 11 shows the external components on a Spectra LS module.

- Notes:**
- The connectors are only used for troubleshooting and diagnostic purposes under the direction of Spectra Logic Technical Support.

- The Spectra LS also contains an internal hard drive that is used for storing the CAN logs used for troubleshooting the library.

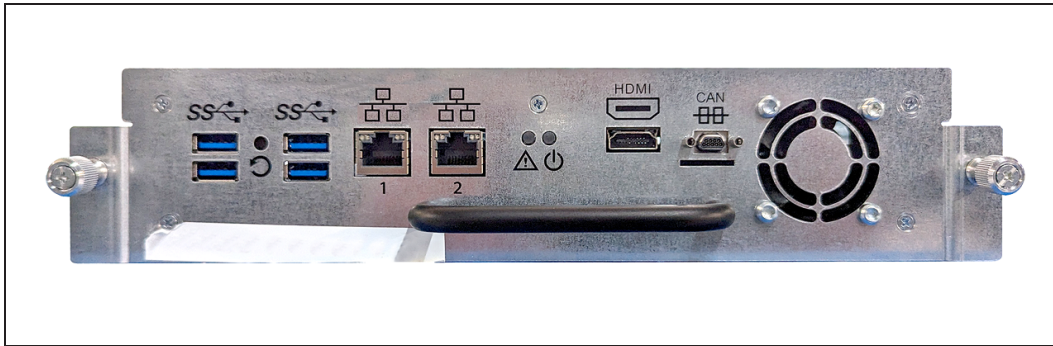

Figure 11 The connectors and components on a Spectra LS.

The following table describes the components shown in Figure 11.

| Component | Description |
|--------------------------------|--|
| USB Ports (4) | The USB ports on the LCM can be used to connect a USB device for transferring BlueScale encryption keys, saving configurations, and uploading LumOS software packages. Note: Not supported in the initial LumOS release. |
| Monitor Connector | You can connect a monitor and use it to view the LumOS user interface instead of using the library front panel. Note: Not supported in the initial LumOS release. |
| Ethernet Port | The left-most Ethernet port on the LCM connects the library to an Ethernet network and is used to access the library through the LumOS web interface using the Remote Library Controller (RLC). The LumOS web interface provides access to all of the options available from the library’s operator panel except those that require physical interaction with the library (for example, importing or exporting media). The Spectra LS has a 10/100/1000BaseT connection. |
| Dedicated EtherLib Port | The right-most Ethernet port on the Spectra LS is configured as a dedicated EtherLib port. EtherLib uses this port to speed communication between components in the library. Note: This port cannot be used to access the LumOS web interface. |

Spectra LS Functionality

The LS module must be installed in the top slot of the main frame where it functions as both the Library Control Module (LCM) and Robotics Control Module (RCM).

The following table describes each function of the Spectra LS control module:

| When functioning as the... | The Spectra LS control module... |
|-------------------------------------|---|
| Library Control Module (LCM) | <p>Runs the LumOS software, which provides the LumOS user interface that is used to perform all configuration, import/export, and management functions for the library. The LumOS user interface is accessible locally through the library's touch screen and remotely using a standard web browser.</p> <p>In addition to providing the user interface, the LumOS software running on the LCM generates and maintains the MLM database, BlueScale encryption keys, system logs, and other information related to the current system status. It also handles email operation.</p> <p>The LCM also processes media changer commands from the hosts and storage management software to control the operation of the TeraPorter. The LCM stores all of the information about the location and status of each element in the library, as well as the raw media inventory in its nonvolatile memory.</p> |

LCR Functionality

The Library Can Repeater (LCR) module is installed in the bottom slot of the main frame. When the library control module issues a command, the LCR duplicates that signal across all frames.

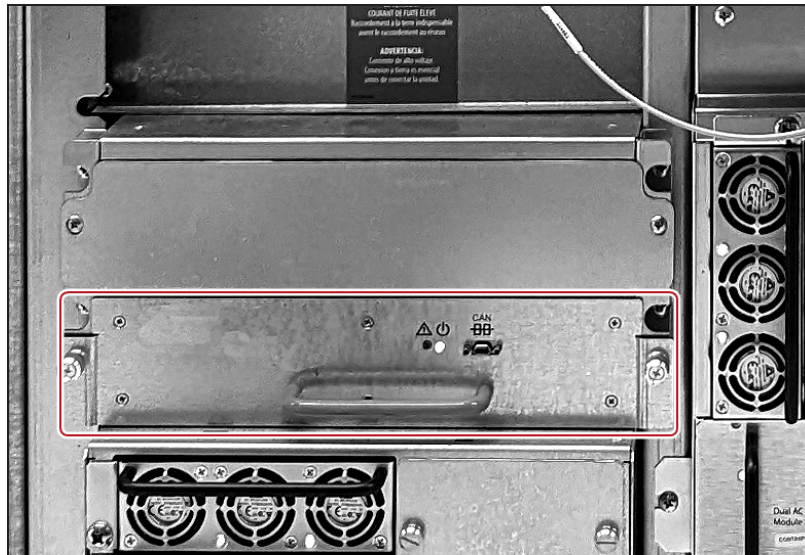

Figure 12 Identifying the LCR in the back of a library.

Exporting Controllers

Either a RIM2, a direct-attached LTO-6 or later generation drive, or TS1155, TS1160, or TS1170 tape technology drive is required to provide the control path for the library's robotics. When configuring a storage partition, the device you select to provide the robotic control path is referred to as the "exporting controller" for the partition.

The controller is the bridge between an external Fibre Channel or SAS connection from the host and the internal interface used by the library. It provides the control path for the media changer commands sent from the host to the library. The controller relays the commands to the LCM, which processes the commands and uses them to control the robotics in the library.

A minimum of one controller is required to connect the library's TeraPorter to the Fibre Channel or SAS network. To learn more about the role the controller plays in the library, see [TeraPorter Connectivity](#).

- Notes:**
- A tape drive can only provide the control path for one partition. A RIM2 can provide the robotic control path for up to 16 partitions.
 - The library supports 12 RIM2 exporters and 48 drive exporters.

RIMs are mounted in the vertical controller bay located along the right side of each DBA.

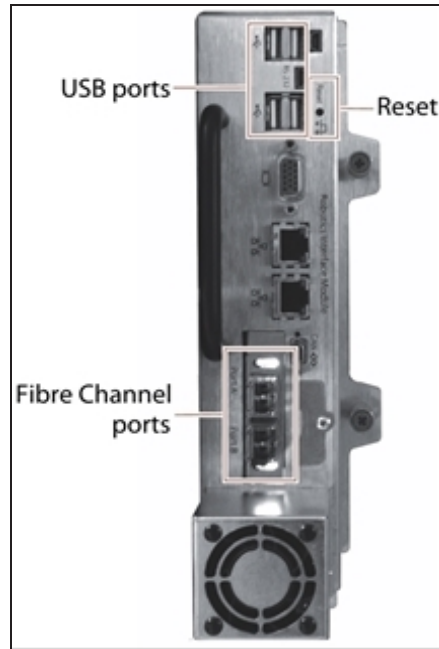

Figure 13 The Robotics Interface Module 2 (RIM2).

The following table describes the controllers supported by the library.

| Controller | Description |
|--|---|
| <p>RIM2</p> | <p>The RIM2 has two dual-channel 8-Gbps Fibre Channel ports (Port A and Port B), which can be used to provide connections to two separate Fibre Channel arbitrated loops or fabrics. The two ports can also be used to provide redundant control paths to the robotics from a single Fibre Channel arbitrated loop or fabric.</p> <p>The USB ports (4) can be used to connect a USB device for updating the RIM2 during a library package update.</p> <p>Notes:</p> <ul style="list-style-type: none"> • The Ethernet ports on the RIM2 are reserved for future use. • The CAN port and monitor port on the RIM2 are for troubleshooting only. |
| <p>Tape Drive (LTO and TS Technology)</p> | <p>The commands to control the motion of the robotics within the partition are sent from the host to the exporting drive’s logical unit number 1 (LUN 1). The motion control commands are then routed to the robotics using the exporting drive’s Automation/Drive Interface (ADI).</p> |

Tape Drives

The library supports LTO-6 and later generation Fibre Channel full-height drives, LTO-7 and later generation half-height Fibre Channel and SAS drives (not shown) and TS11xx technology drives. The drives are mounted in drive sleds, which are installed in DBAs in the main and drive expansion frames. Each DBA can accommodate up to four drives. Drives are hot-swappable to provide uninterrupted operation.

Note: To prevent issues with transporter position calibration, do not put labels on the front face of drives.

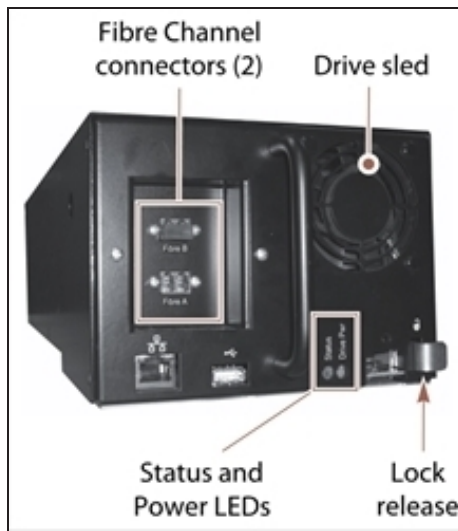

Figure 14 The LTO-5 and later Fibre Channel drive sled.

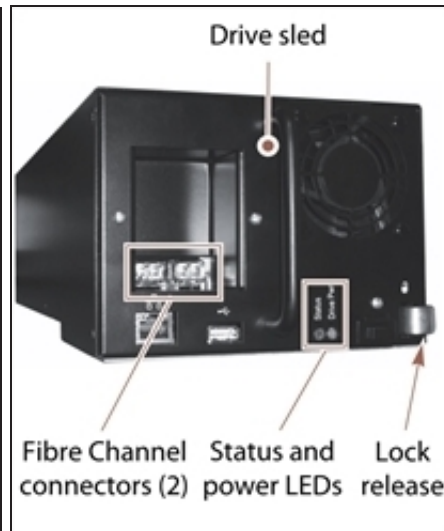

Figure 15 The TS11xx technology drive sled.

The following table describes the drive components.

| Component | Description |
|-------------------|--|
| Drive Sled | <p>The drive sled provides the electrical and logical connections to the library, as well as the connections to the host Fibre Channel arbitrated loop or fabric or SAS network.</p> <p>The drive sled firmware assigns an identifier to the drive based on its location in the library (see Drive Identifiers). This identifier is used to identify the drives in the LumOS user interface and API interface.</p> <p>See Drive Connectivity for additional information about the Fibre Channel connectivity provided by the drive sled.</p> |

| Component | Description |
|---------------------------------|--|
| Fibre Channel Connectors | Each Fibre Channel drive sled has two multi-mode optical SFP LC connectors (Port A and Port B) that are used to connect the drive directly to a Fibre Channel network. The two ports let you connect two separate fiber optic cables to each drive. Note: For half-height drives in a full-height sled, only port A is available. |
| SAS Connector | Each SAS drive sled has a two, unshielded, single-port SFF-8088 (LTO-6 through 8) or SFF-8644 (LTO-9) serial connector that provides the Serial Attached SCSI (SAS) connectivity for the drive. |
| Status LED | Indicates the operational status of the drive sled (not the drive). <ul style="list-style-type: none"> • Flashing green — The drive sled is functioning normally. • Flashing red/orange — The drive sled has experienced an error. • Alternating flashing green and red/orange — The drive is ready for replacement. |
| Drive Power LED | Indicates if the drive is powered on. |
| Lock Release | The drive sled automatically locks into place when it is installed in the DBA to keep it from being accidentally pulled out of the library. The lock release disengages the lock. |
| Ethernet and USB Ports | These ports are typically unused, however, they may be used by service personnel to perform drive firmware updates. |

For more information about the drives in the library, see:

- [LTO Ultrium Tape Drives on page 16](#) for a list of documents that provide information that is applicable to all IBM LTO tape drives.
- [TS11xx Technology Drives on page 16](#) for a list of documents that provide information that is applicable to TS11xx technology drives.
- [LTO Tape Drive Specifications on page 235](#) for information about the transfer rates and storage capacities of LTO drives.
- [TS11xx Technology Tape Drive Specifications on page 239](#) for information about the transfer rates and storage capacities of TS11xx technology drives.
- [Network Interface Cable Requirements on page 232](#) for cabling requirements for host connections to the drives.

SpectraVision Camera

The SpectraVision camera lets you view the interior of the library while it is operating. The main frame usually contains a camera. In multi-frame libraries, additional cameras can be installed in the expansion frames to provide monitoring of the entire library. Each camera can view the interior of the frame where it is mounted and a portion of one frame to either side.



Figure 16 White SpectraVision camera.



Figure 17 Black Spectra Vision camera.

The SpectraVision camera is mounted at the top rear of a frame. The camera lets you observe import and export operations, tape mounts, cartridge moves, and robotic operations in real time. The ability to view the interior of the library without removing the side panels provides an additional level of monitoring for your library.

- Notes:**
- The LED lights mounted at the top of each frame provide illumination for the camera.
 - The library must be powered-down to replace the SpectraVision camera.

TERAPACK CARTRIDGE HANDLING

The library optimizes space usage by storing media on horizontal shelves. This horizontal storage provides very high density by using space within the library instead of the limited space provided by the vertical library walls. Each horizontal shelf is divided into multiple equal-sized media storage chambers. Each chamber accommodates a single TeraPack magazine.

The library uses TeraPack magazines to import and export cartridges through the TAPs and to store cartridges inside the library. Each magazine holds up to ten LTO cartridges or nine TS11xx technology cartridges. The magazine has guides along each side and grooves on the bottom to ensure proper alignment when it is inserted into the TAP.

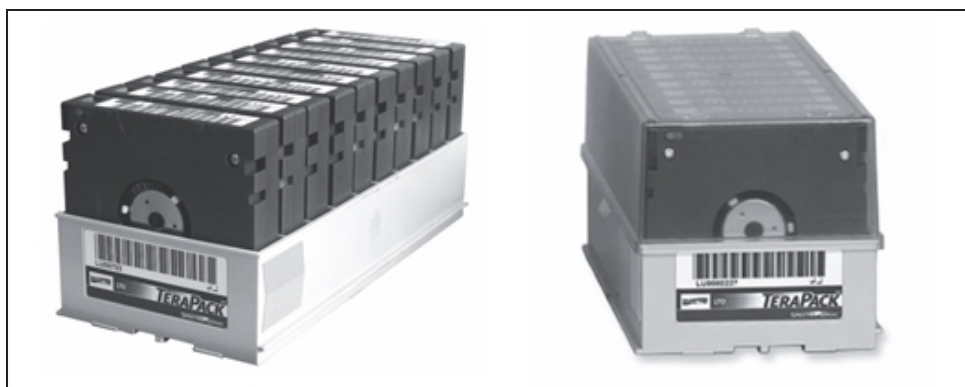

Figure 18 TeraPack magazine with barcode labeled cartridges and plastic dust cover (LTO shown).

Storing and handling cartridges in TeraPack magazines helps eliminate errors resulting from mishandling individual tapes, which is the leading cause of tape damage. When inside the library, TeraPack magazines are stored in semi-enclosed chambers. When not in the library, an optional clear plastic dust cover snaps onto the magazine to protect the cartridges. The cartridges are continually protected by the TeraPack magazine, both inside and outside of the library.

Using TeraPack magazines offers the following advantages:

- **Barcode labeling** All of the cartridges in a TeraPack magazine, as well as the magazine itself, are barcode labeled for easy identification.
- **Grouped media** The cartridges in a TeraPack magazine are treated as a single unit during import and export operations. This grouped media handling simplifies media management tasks by eliminating the need to import or export cartridges one by one.

LIBRARY EXPANSION AND UPGRADES

The T950 library is designed to transform and expand to meet a data center's changing storage requirements, as well as to achieve storage consolidation goals. See for additional information.

Capacity on Demand (CoD)

The library's capacity-on-demand feature (CoD) lets you purchase a library that suits your current needs and then purchase additional capacity later as required. CoD reduces up-front costs as you only pay for what you currently need. As more capacity is required, it can be added in increments by purchasing activation keys to license additional chambers in the library. You can then import additional TeraPack magazines to fill the licensed chambers.

Modular Expansion

The modular design makes it possible to increase media storage capacity or number of drives in the library to meet storage and performance needs as they evolve within an organization. From the basic three-frame T950 library configuration, additional expansion frames can be added to increase the tape slot and drive capacities. See [Drive, Media, and Service Frames](#) for more information.

OVERVIEW OF THE LUMOS USER INTERFACE

The LumOS user interface lets you set configuration options, view library and drive information and metrics, manage media, monitor library operations, and perform maintenance operations.

Access Options

The LumOS user interface is accessed using either the touch screen on the library operator panel or through the LumOS web interface.

Operator Panel Touch Screen Interface

The touch screen on the operator panel of the main frame is the library's local LumOS user interface. You select options and enter information by simply touching the appropriate location on the screen with a stylus or your finger. The touch screen interface includes a soft keyboard that you can use to enter characters into the text fields.

LumOS Web Interface

The LumOS web interface lets you use a standard web browser to access the library through the Remote Library Controller (RLC). Simply enter the library's IP address into a browser running on a computer, tablet, or phone that can access the Ethernet network connected to the library's LCM module.

The LumOS web interface provides access to the same features and functions that are available through the touch screen, excluding functions that involve physical interaction with the library.

Note: Users with sufficient permissions can manually override and remove the restrictions on functions that involve physical interaction.

When using the web interface, keep the following requirements in mind:

Supported Browsers

Remote access to the library through the web interface is only officially supported using the Google[®] Chrome[™] browser.

Additional browsers have not been fully tested with the LumOS web interface. Using an unsupported browser may result in the LumOS web interface not displaying or operating as expected.

User Interface Features

The following sections describe the common LumOS user interface features.

Toolbars

The toolbar panel appears along the top edge of each screen and lets you navigate through the available toolbars to select options. Clicking on a toolbar expands it to display the available options.

Option Overview

The following table provides an overview of the options available under each toolbar.

| Toolbar | Available Options |
|----------------------|--|
| Status | <ul style="list-style-type: none"> • Dashboard - Provides an overview of the library and its components, including library capacity, tape drive and media status, robot status, environmental and power information, and a list of the last 20 media moves performed by the library., • Status Messages - Displays Info, Summary, Warning, Error, and Fatal Error messages. • DLM - (Drive Lifecycle Management) - Displays all present drives with access to their health status, mount history, and details. • MLM - (Media Lifecycle Management) - Displays all present tapes with access to their health status, barcode, and details. • Robotics - Displays the status of the robots inside the library and their details. When using the operator panel, users can send the robots to service. • Library Hardware - Displays the health status and details of all hardware present in the library. • Environment - Displays temperature and humidity information. • Power Usage - Displays the wattage used by the library. • Firmware Update Status - Displays the status of each firmware update check, which is performed each time the library is powered on, or when the LumOS software restarts. |
| Configuration | <ul style="list-style-type: none"> • Partitions - Displays all Cleaning and Storage partitions. Users can use the Partitions screen to create, edit, and delete partitions. • Package Update - Displays the active package and allows users to upload, change, and delete packages. |

| Toolbar | Available Options |
|-------------------|--|
| | <ul style="list-style-type: none"> • Drive Firmware Update - Displays the Drive Firmware Update screen, which provides controls for staging and committing drive firmware updates. • Settings - Displays the Settings screen, which allows users to modify basic, authentication, network, and metric settings. • Licensing - Displays the Licensing screen, which allows users to view existing licenses and add new license keys. • User Management - Displays the Users screen, which allows users to create, edit, or delete users. • Encryption - Displays the Encryption screen, which allows users to add, import, export, or delete a BlueScale encryption key, add a KMIP server, and change the encryption password. |
| Operations | <ul style="list-style-type: none"> • Move Media - Displays all Cleaning and Storage partitions and allows users to move media inside the library. • Exchange Media - Only accessible on the operator panel. Displays all pools and magazines and allows the user to import or export magazines through the main and bulk TAPs. • Import Media - Only accessible on the operator panel. Displays all available partitions and allows the user to import magazines into partitions using the main and bulk TAPs. • Export Media - Only accessible on the operator panel. Displays all available partitions and allows the user to export magazines from partitions using the main and bulk TAPs. |
| Tools | <ul style="list-style-type: none"> • Log Gather - Displays the Log Gather screen, which allows the user to select a log type and time range and initiate a log gather. • Backup/Restore - Displays the Backup/Restore screen, which allows the user to create, delete, upload, download, and restore from a backup file. • Diagnostics & Utilities - Displays the Diagnostics screen, which allows the user to run diagnostics to troubleshoot the library. These tests should only be performed under guidance from Spectra Logic Technical Support. • Alerts - Displays the Alerts screen, which allows the user to configure automatic alerts and add subscribers to the alert mail list. |

LOGGING IN TO THE LUMOS USER INTERFACE

To log in to the LumOS user interface, use the front panel. To access the web interface, use the front panel to determine the T950 library's IP address, then open a web browser on a computer on the same network and enter the IP address of the library. The login screen displays.

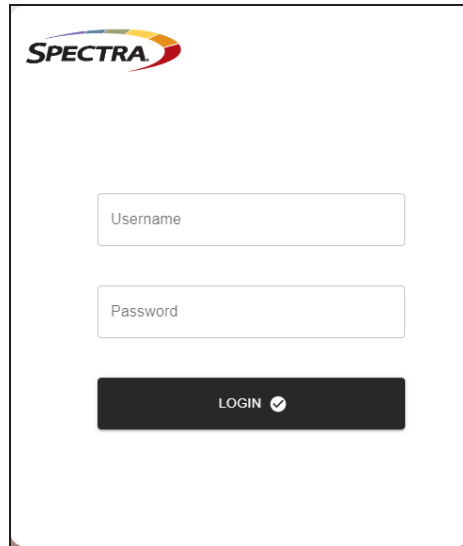

Figure 19 The T950 Login screen.

Enter in the **Username** and **Password** and click **Login** to log in.

- The default username is **su**.
- The default password is **spectra**.

Note: When logging into the LumOS interface, the web page defaults to the Dashboard.

The LumOS Web Interface

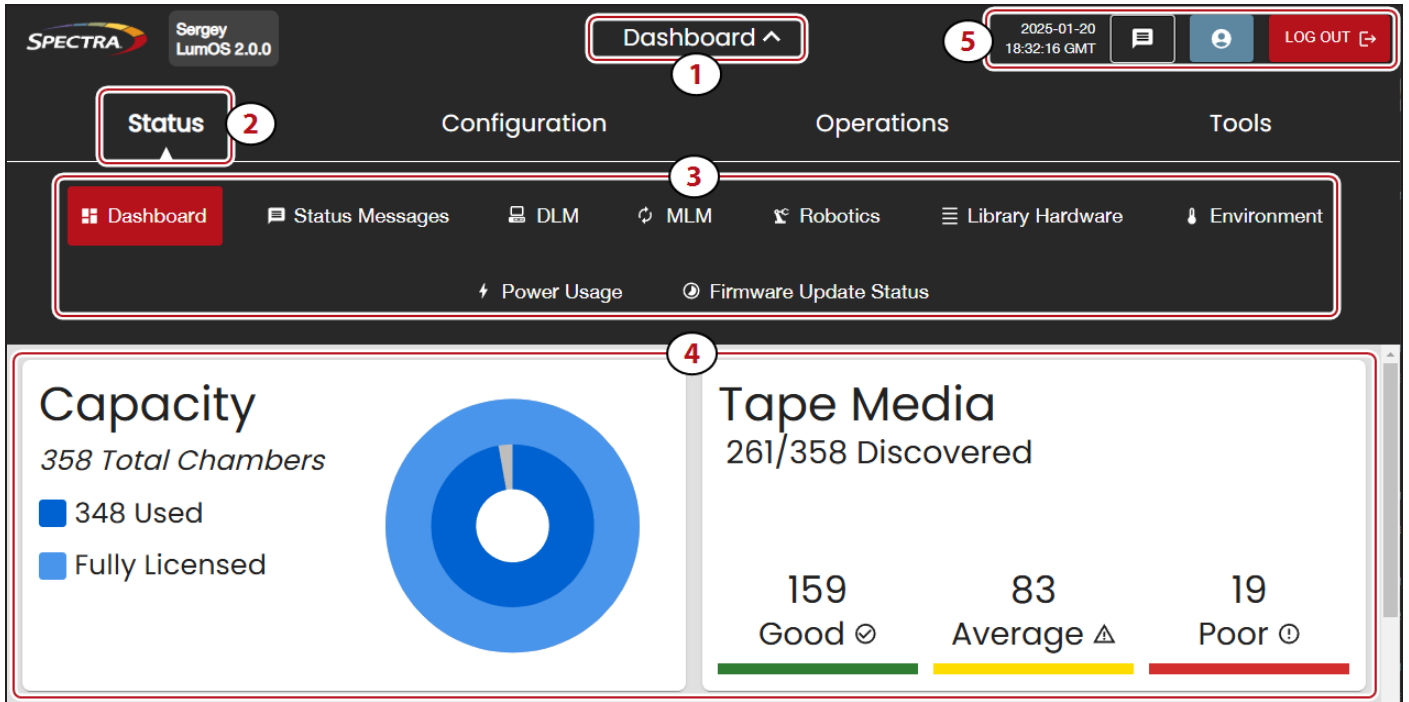

Figure 20 The LumOS web interface features.

1. The current selected screen.
2. The current selected toolbar.
3. All feature screens available under the current selected toolbar.
4. The selected feature screen.
5. The current system time, and buttons for accessing system messages, user configuration, and to log out of the LumOS interface.

Dashboard

The LumOS user interface dashboard provides an overview of the T950 library status. Expand the title bar and then select **Status > Dashboard**. Use the figure below to help you navigate the dashboard.

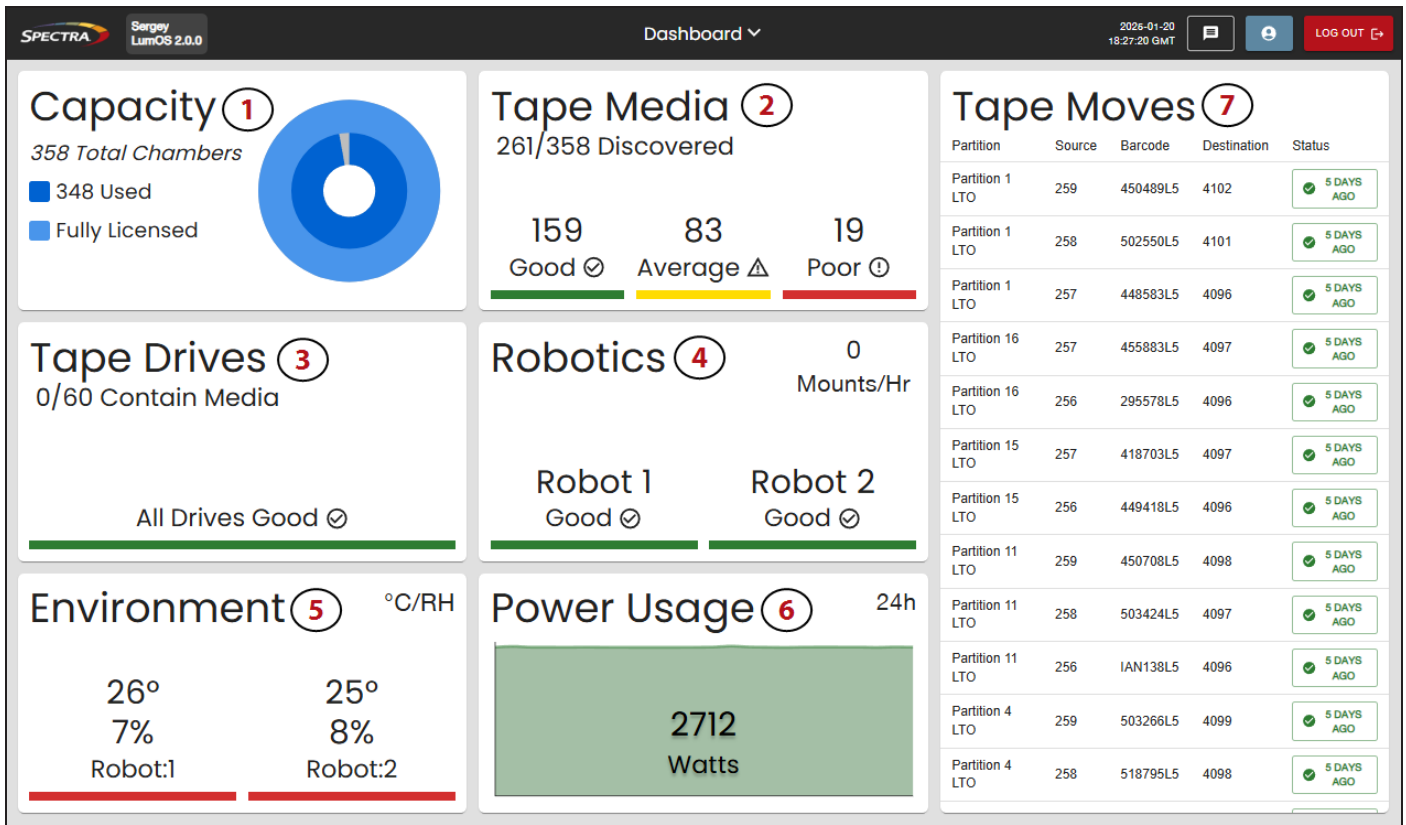

Figure 21 The T950 Dashboard.

T950 Dashboard

- Capacity** - The tape media storage capacity of the library. Click the widget to view the current license keys installed in the library, and to add new license keys.
- Tape Media** - The current number of tape cartridges in the library, and the general status of all media. Click the widget to view the Media Lifecycle Management screen.
- Tape Drives** - The current number of tape drives in the library, and the general status of the tape drives. Click the widget to view the Drive Lifecycle Management screen.
- Robotics** - The number and status of the robot(s) installed in the library, as well as the total mounts per hour. Click the widget to view the Robotics screen for more detailed information.
- Environment** - The current temperature and humidity readings for the robot(s) installed in the library. Click the widget to view the Environment screen for more detailed information.
- Power Usage** - The current wattage used by the library. Click the widget to access the Power Usage screen for more detailed information.
- Tape Moves** - The last 20 tape media moves performed by the library.

OVERVIEW OF THE LUMOS API

The LumOS API for the T950 tape library allows you to control all aspects of the library that are available when using the library front panel or remote library connection.

Note: The API is updated every time the LumOS software is updated.

Accessing the LumOS API

The LumOS API is accessed using the following path:

`https://library IP address/api`

For example:

`https://10.10.11.203/api`

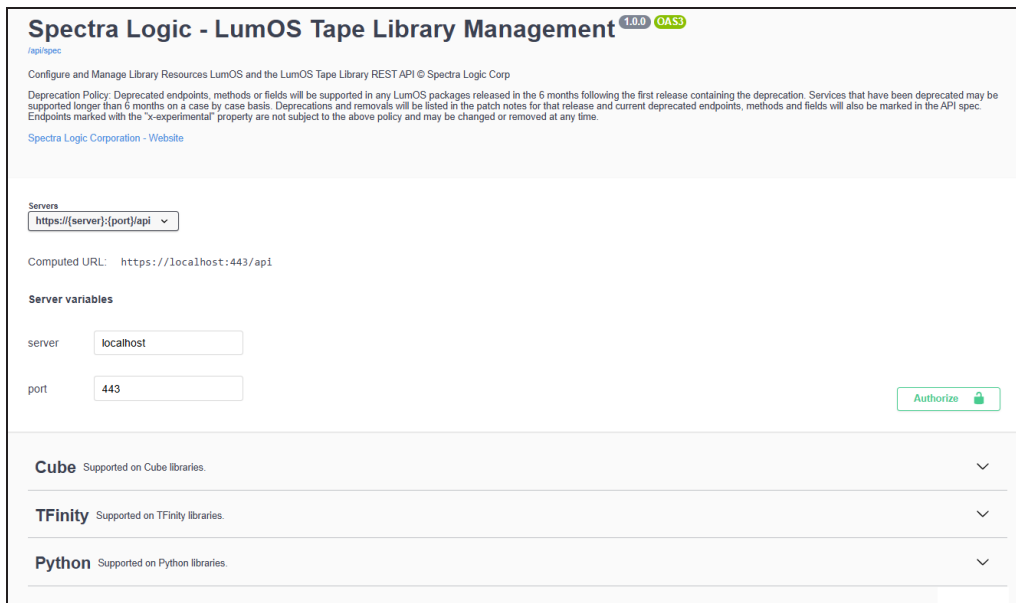

Figure 22 The main screen of the LumOS API.

Authentication in ReST API

Authentication in a REST API ensures that only authorized users can access or modify resources. The client sends credentials to the library, the library checks the provided credentials, and issues a Bearer token the user must use in the request headers for all future requests. A token is returned by sending a POST command to 'api/auth/login' with the required request body, and then using the token returned in the JSON body by the authorization HTTP header for subsequent requests.

Sample API Command

The below sample API command shows the login process using Curl.

Command:

```
curl -k -H 'Content-Type: application/json' -d '{"username":"su","password":"spectra",  
"domain":"NATIVE"}' -X POST https://10.10.11.203/api/auth/login
```

Response:

```
{"passwordHasExpired":false,"refreshUntil":1738180782,"token":"eyJhbGciOiJIUzI1NiIsInR5cCI6IkpXVCJ9.eyJ0eXBlijozLCJncm91cHMioIlsiU3VwZXJvc2VyIl0sImRvbWVpbiI6Ik5BVElWRSlSImxhc3RQYXNzd29yZFNldFRpbWUiOjE3MzgwNzkzNTYwMTc0MDAwMDAsInBhc3N3b3JkSGFzRXhwaXJlZCI6ZmFsc2UsInJlZnJlc2hVbnRpbCI6MTczODE4MDc4Miwic3ViIjoic3UiLCJleHAiOjE3MzgwOTUyODIsImhhdCI6MTczODU5NDM4MiwianRpIjoieTYxODIjOGItNzM3Yi00NWEwLTk0YjAtOTQ5NGE2NTg1MDhhIn0.svJOVzxbJICUuvdWYnWnby5azQcxwQ3QEcxpSwF7uvo","tokenExpiresAt":1738095282}
```

API Updates

The LumOS API is updated whenever the LumOS system software is updated. New API commands are listed in the Release Notes for each LumOS software release.

CHAPTER 3 - ARCHITECTURE OVERVIEW

The T950 library is designed to provide maximum flexibility and ease of use in an enterprise-class system.

| | |
|--|-----------|
| Media Pools | 56 |
| Library Partitions | 58 |
| Storage Partitions | 58 |
| Cleaning Partitions and Auto Drive Clean | 59 |
| Drive and Media Frames | 61 |
| Component Identifiers | 63 |
| Drive Identifiers | 64 |
| Connectivity | 65 |
| TeraPorter Connectivity | 65 |
| Drive Connectivity | 68 |
| High-Availability Configurations | 69 |
| Redundant Connectivity | 69 |
| Robotics Failover | 70 |
| Redundant Power Supplies | 70 |

MEDIA POOLS

Inside the library, magazines and cartridges are logically grouped through the use of pools. These pools are made up of chambers, each of which accommodates a single magazine. The library has three different types of pools: storage pools, entry/exit pools, and the free pool.

Storage pool

The chambers in a storage partition's storage pool provide the cartridge storage for a partition. You specify the number of chambers assigned to a storage pool when you create a partition.

- Each storage partition has its own storage pool containing at least one chamber. The cartridges in the storage pool are available for use by the host storage management software that accesses the partition.
- A cleaning partition has at least one chamber in its storage pool and can be shared by multiple storage partitions if they all use the same type of cleaning cartridge. The cleaning cartridges stored in the cleaning partition are not accessible to the storage management software.

Entry/Exit pool

The chambers in an entry/exit pool provide an interim storage location for cartridges during import and export operations. You specify the number of entry/exit pool chambers when you create a storage partition. Cleaning partitions do not have an entry/exit pool.



IMPORTANT

The host storage management software cannot use the cartridges in the entry/exit pool for backup jobs. However, the storage management software can access the cartridges stored in the entry/exit pool to move them into the storage pool.

A cartridge is in the entry/exit pool for one of the following reasons:

- It was ejected from the storage pool by the storage management software, or moved manually using the LumOS user interface.
- A magazine containing one or more cartridges was imported into the library. From the entry/exit pool, the cartridges can be imported into the storage partition's storage pool.
- A magazine containing one or more special-purpose cartridges was imported into the library using the TAP. These cartridges may be used for cleaning a drive.

Free pool

Chambers that are not assigned to a partition are in the free pool. These chambers can be assigned to a storage partition or a cleaning partition. The chambers in the free pool cannot be accessed through the user interface or the storage management software until they are added to a partition.

LIBRARY PARTITIONS

Partitions divide the library logically to appear as one or more physical libraries—one library per configured partition. Partitioning simplifies storage consolidation through the creation of virtual libraries, each with its own drives and media. Each partition:

- Has exclusive access to the tape drives and media storage assigned to it.
- Can control the TeraPorter to move media within the partition.

The library supports two types of partitions, storage partitions and cleaning partitions. You can configure a maximum of 16 partitions using the maximum number of physical controllers noted below. One or more cleaning partitions can be configured in a single library. A single cleaning partition can be associated with multiple storage partitions. Cleaning partitions do not count against the storage partition maximum.

Note: The more partitions in a library, the longer each move can take. You may need to increase the timeout setting in your storage management software.

Storage Partitions

Overview

The library requires, at a minimum, one storage partition. Each storage partition must have at least one drive and one chamber in its storage pool. Drives and chambers can only be assigned to one storage partition at a time.

In some environments, using multiple storage partitions is crucial to data center efficiency and growth. For example, multiple partitions are extremely useful in the following situations:

Multiple Storage Management Software Packages

If groups within your company use different storage management software packages, each software package requires its own dedicated library. Instead of maintaining multiple physical libraries — one per backup package — the data center can use a single Spectra Logic library with multiple partitions, in which each partition appears to the software as a dedicated library.

Encryption

If you want to encrypt some but not all of your backup data, you can partition the library into an encryption partition and non-encryption partition to segregate the two types of data.

Multiple Drive Generations

If your data center uses multiple generations of LTO drives, Spectra Logic strongly recommends configuring separate partitions for each generation to ensure read/write compatibility between the drives and cartridges.

Shared Resources

If each department in the company must keep their data segregated, partitioning the library supplies this segregation, as well as the subsequent integrity of the data set. Each partition can only access the drives and cartridge locations assigned to it. Data from other partitions cannot become intermixed with the data stored on the media in the partition's inventory.

Multiple Databases

If your company uses multiple databases, partitioning the library preserves the backup processes associated with each type of database.

Cleaning Partitions and Auto Drive Clean

Overview

The cleaning partition provides permanent storage for cleaning cartridges inside the library. This special-purpose partition does not have an entry/exit pool or any drives associated with it. A single cleaning partition can be shared by multiple storage partitions.

Auto Drive Clean uses the cleaning cartridges in the cleaning partition to provide library-based cleaning of drives with minimal user intervention. Automated drive cleaning results in fewer failed tape read/write operations and is the preferred method for cleaning drives.

Drives in a partition with an associated storage partition are cleaned no more than once in any 12 hour period.

Note: Software-initiated drive cleaning operations cannot use the cleaning cartridges stored in a cleaning partition; the cartridges are not accessible to the storage management software.

Requirements

The Auto Drive Clean feature requires a cleaning partition to be associated with the storage partitions that contain the drives you want to clean.

Cleaning cartridges used in a cleaning partition must be stored in specially labeled Maintenance TeraPack magazines. The cartridges themselves must be identified with "CLN" at the beginning of the barcode on their labels. The library prevents you from importing cleaning cartridges and magazines that are not properly labeled into a cleaning partition.

Auto Drive Clean Operation

When a drive is unloaded in response to a host request and the data cartridge is moved to its storage location, the library queries the drive to determine if it needs cleaning. If cleaning is required, the library delays notifying the host that the SCSI move command for the unloaded data cartridge is complete while it performs an automatic drive cleaning.

During the delay, the library retrieves a cleaning cartridge from the cleaning partition and inserts it into the drive. When the cleaning is complete, the library returns the cleaning cartridge to the cleaning partition and notifies the host that the SCSI move command for the unloaded data cartridge is complete. The library then posts a system message that the cleaning was successful.

Expired Cleaning Cartridges

When an expired cleaning cartridge is loaded into a drive, it is immediately ejected without attempting the cleaning. The library flags the cleaning tape as expired in its inventory and does not attempt to use it for subsequent cleanings.

If the cleaning partition contains another valid cleaning cartridge, a cleaning that failed because of an expired cleaning cartridge is reattempted the next time the host unloads a data cartridge from the drive.

MLM Tracking of Cleaning Cartridges

When you use MLM-enabled cleaning cartridges, the library stores usage information in the MLM database, including the number of cleans remaining and the cartridge health - good, near expiration or expired. This information is retained in the MLM database when a cleaning cartridge is exported from the library.

When a cartridge is nearing the end of its useful life, the library notifies you so that you can replace the cartridge. This early notification helps prevent failed cleanings resulting from using an expired cleaning cartridge.

The library does not store any information about non-MLM cleaning cartridges in the MLM database. However the library does mark an expired cleaning cartridge and does not attempt to use it again as long as it remains in the library. If an expired non-MLM cartridge is exported and then re-imported into the library, it is identified as expired the next time it is loaded into a drive.

DRIVE AND MEDIA FRAMES

The T950 library's modular design makes it possible to increase media capacity or the number of drives in the library to meet storage and performance needs as they evolve. Expansion frames can be added to the basic single-frame library for a maximum of eight frames.

As viewed from the front of the library, the main frame must be positioned as the left-most frame or the frame immediately to the right of the bulk TAP. Up to four drive expansion frames can be located immediately to the right of the main frame. Media frames can be located to the right of the main frame and any drive frames.

The following table shows the number of media storage chambers and drives in each type of frame in the T950 library.

| Frame Type | Number of Chambers | Number of slots | Maximum Number of Drives |
|---|--------------------|-----------------|--------------------------|
| LTO Library | | | |
| T950 main • 3 DBAs/3TBAs | 95 | 950 | 12 |
| • 6 DBAs | 83 | 830 | 24 |
| T950B main • 1 DBAs/shelves | 100 | 1000 | 4 |
| • 3 DBAs/3 TBAs or shelves | 92 | 920 | 12 |
| • 6 DBAs | 80 | 800 | 24 |
| T950B main with a bulk TAP • 1 DBAs/shelves | 110 | 1100 | 4 |
| • 3 DBAs/3 TBAs or shelves | 98 | 980 | 12 |
| • 6 DBAs | 80 | 800 | 24 |
| Drive expansion (optional) • 3 DBAs/3 TBAs | 101 | 1010 | 12 |
| • 3 DBAs/ shelves | 107 | 1070 | 12 |

| Frame Type | Number of Chambers | Number of slots | Maximum Number of Drives |
|---|--------------------|-----------------|--------------------------|
| • 6 DBAs | 89 | 890 | 24 |
| Media expansion (optional) | 130 | 1300 | None |
| Bulk TAP expansion (optional) | 91 | 910 | None |
| TS11xx Technology Library | | | |
| T950B main • 1 DBAs/shelves | 82 | 738 | 4 |
| • 3 DBAs/shelves | 76 | 684 | 12 |
| • 6 DBAs/shelves | 66 | 594 | 24 |
| T950B main with a bulk TAP • 1 DBAs/shelves | 90 | 810 | 4 |
| • 3 DBAs/shelves | 81 | 729 | 12 |
| • 6 DBAs/shelves | 66 | 594 | 24 |
| Drive expansion (optional) • 3 DBAs/shelves | 90 | 810 | 12 |
| • 6 DBAs/shelves | 75 | 675 | 24 |
| Media expansion (optional) | 110 | 990 | None |
| Bulk TAP expansion (optional) | 77 | 693 | None |

COMPONENT IDENTIFIERS

The library user interface and the API command interface use component identifiers for each drive. These identifiers also appear in system messages. The component identifier is based on the component’s location relative to the frame and drive bay assembly (DBA) where it is installed.

Figure 23 shows the relationship between the DBAs and the locations of the drives in the main frame. The relationships are the same in each drive expansion frame.

- Notes:**
- DBAs are numbered from the bottom up, with DBA 1 being the bottom-most.
 - Drives are numbered from left to right and bottom to top in a DBA, as viewed from the back of the library. Each DBA can hold up to four drives.
 - If the frame contains 3 DBAs, DBAs 3, 4, and 5 become TBAs or shelves.

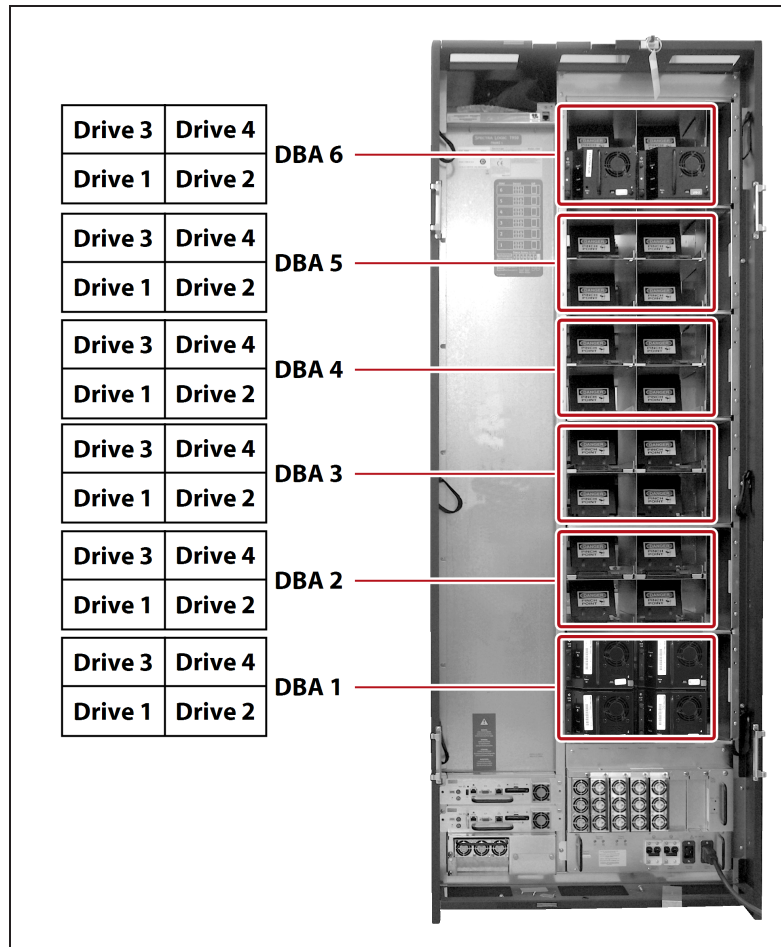

Figure 23 The relationship between the DBA, drive locations and their identifiers in the user interface and API interface.

Drive Identifiers

The firmware in the drive sled that houses each drive assigns an identifier to the drive based on its location in the library. The identifier is also used to generate the World Wide Name (WWN) that the library reports for the drive (see [World Wide Names for Fibre Channel Drives on page 68](#)). Because the identifier is location-based, it remains constant even if the physical drive is replaced by a new drive. The new drive assumes the location-based identifier.

CONNECTIVITY

The library TeraPorter and the drives connect to the host system over a Fibre Channel arbitrated loop or fabric, or a SAS fabric. These connections carry two types of information:

- The commands from the storage management software that control the TeraPorter motion and the read/write operations of the drives.
- The data being transferred to and from a drive by the host.

TeraPorter Connectivity

From the host perspective, both single TeraPorter libraries and dual TeraPorter libraries contain a single TeraPorter. The library manages the two TeraPorters in a dual TeraPorter library to provide the most efficient operation.

The TeraPorter requires a drive or RIM2 to provide the robotic control path. When configuring a storage partition, the drive or RIM2 you select to provide the robotic control path is referred to as the “exporting controller” for the partition. The exporting controller makes the partition accessible to the hosts as a media changer (a library). It receives the media changer commands sent from the host to the library and relays them to the LCM, which in turn processes them into the motion commands used to control the robotics.

You can select multiple exporting controllers for a partition and use your host software to either export the same changer interface over the controllers to provide redundancy.

Control Path Through a Direct-Attached Drive

In a direct-attached drive configuration, one or more drives in a storage partition are designated as the exporting drive (also know as the exporting controller). The commands from the host to control the motion of the robotics within the partition are routed to the exporting drive’s logical unit number 1 (LUN 1). Commands to control the operation of the exporting drive are sent from the host to LUN 0 of the drive.

- Notes:**
- If you have multiple storage partitions, you must designate an exporting controller for each partition.
 - A drive can only provide the robotic control path for the partition to which it is assigned.
 - You can select multiple drives as controllers, and export the same changer interface over the drives to provide redundancy, as long as your storage management software can support this. These multiple paths cannot be used at the same time.
 - Assigning multiple drive exporters to one partition reduces the total number of partitions that can be configured in the library.

Figure 24 shows an example of a partition with two Fibre Channel drives providing the robotic control path. LUN 1 on the drives provides the robotic control path over which the commands to the robotics are received from the host.

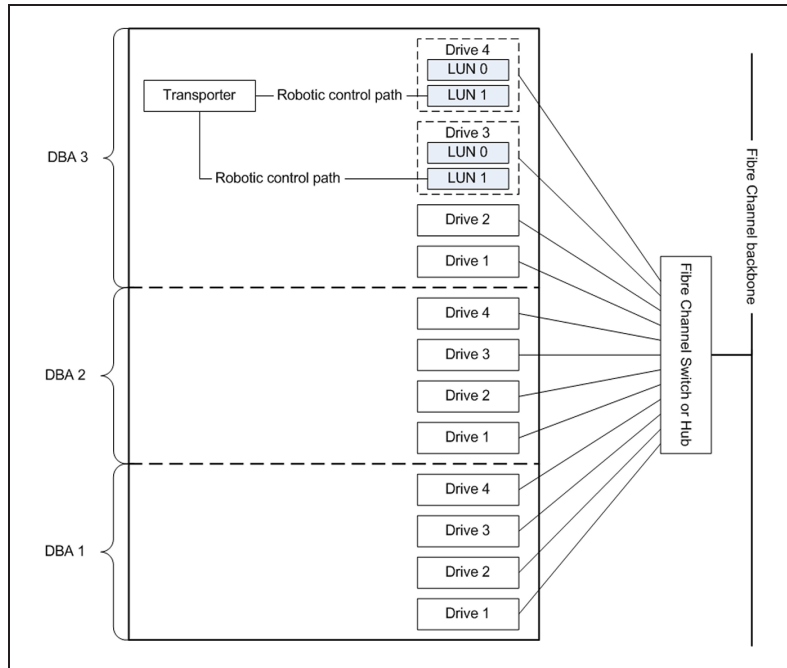

Figure 24 An example of a partition with two direct-attached Fibre Channel drives providing the robotic control path.

Control Path Through a RIM2

A RIM2 provides the bridge between the external Fibre Channel interface from the host and the internal interface used by the library to communicate with the TeraPorter.

A RIM2 can support up to 16 partitions. Each partition has full control of the robotics. For example, if the library contains two partitions, a single RIM2 can provide the robotic control path for both partitions.

If desired, you can configure multiple RIM2s as exporters for the same partition and use your host software to either export the same changer interface over the RIM2s to provide redundancy.

Figure 25 shows an example of a partition with Fibre Channel drives and a RIM2. Port A on the RIM2 provides the robotic control path over which the commands to the TeraPorter are received from the host.

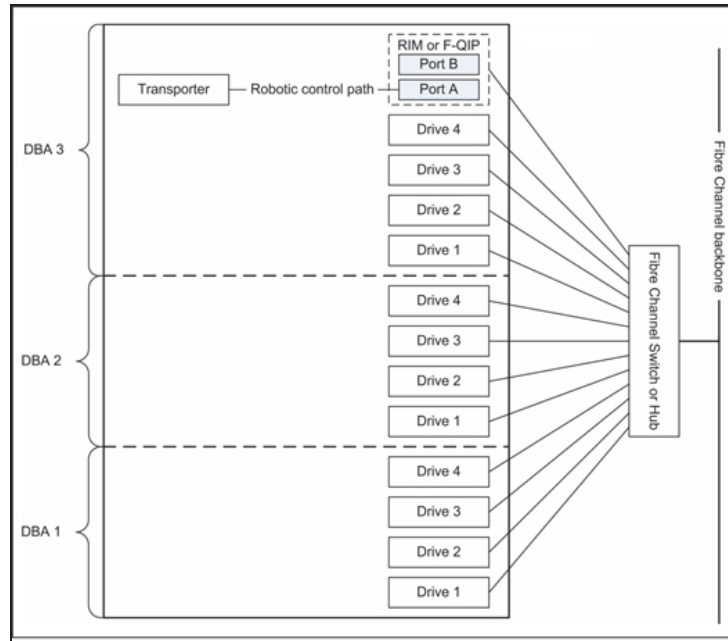

Figure 25 An example of a RIM2 in a partition with direct-attached Fibre Channel drives.

World Wide Names for Partitions

The World Wide Name (WWN) displayed for each partition is the WWN of the controller (RIM2) that provides the robotic control path for the partition (the exporting controller). The WWN is based on the physical location of the RIM2 in the library and remains constant even if the RIM2 is replaced. The new RIM2 assumes the location-based WWN.

- The partition WWN is the World Wide Node Name (WWNN) for the exporting controller.
- If multiple partitions use the same Fibre Channel port on the RIM2, all of the partitions have the same WWNN and the same World Wide Port Name (WWPN). However, the partitions will have different LUNs under those controllers, starting at LUN zero (0).
- If you create two partitions and configure one partition to use Port A and another to use Port B, the WWNN/WWPN of port A will start with 21 and the WWNN/WWPN of port B will start with 22. In this case the ports are independent.
- If you export the same partition out both port A and port B on a RIM2, the WWNN will be the same for both ports but the WWPN will be different. This scenario is a type of redundant path to the robotics.

For Partitions with a Drive or Drives as the Exporting Controller

The partition WWN is the same as the WWN for the drive. The commands to control the motion of the robotics within the partition are sent from the host to the exporting drive's logical unit number 1 (LUN 1). Commands to control the operation of the exporting drive are sent from the host to LUN 0 of the drive.

See [World Wide Names for Fibre Channel Drives](#) below for more information about WWNs for drives.

Drive Connectivity

The drives in the library have either a Fibre Channel interface or a SAS interface.

- Serial Attached SCSI (SAS) drives connect directly to a SAS HBA.
- Fibre Channel drives connect directly to the host using a Fibre Channel arbitrated loop or fabric.

[Figure 25 on page 67](#) is a simple representation of how the robotics and direct-attached Fibre Channel drives are connected directly to a Fibre Channel SAN through a switch or hub.

Note: When connecting Fibre Channel drives to an arbitrated loop, keep in mind that all of the drives on an arbitrated loop must share the data transfer capacity (bandwidth) of the interface. Having multiple devices on the same loop can negatively impact the performance of all the devices.

World Wide Names for Fibre Channel Drives

As part of providing network connectivity, the drive sled firmware assigns a location-based WWN for the drive it houses. This WWN is used by the host software to address the drive. Because this WWN is location-based, it remains constant even if a drive is replaced by a different one of the same type. The new drive assumes the location-based identifier and WWN.

Note: The WWN displayed on the Drive Details screen is actually the WWPN for port A on the drive sled. The WWPN for port B is the same as the one for port A except that the second digit from the left is **2** instead of **1**.

HIGH-AVAILABILITY CONFIGURATIONS

In high-availability enterprise environments, keeping the library operating even in the event of a network connection failure or component failure is extremely important.

Redundant Connectivity

In a high-availability environment, the ability to maintain communications between the host systems and the library and its drives in the event of a connection failure is essential.

- The library can be configured to use two RIM2s or two tape drives to provide redundant connectivity to the media changer functionality of the library.
- Alternatively, multiple RIM2s in a partition can be configured to export the same changer interface to provide redundancy.
- The servers and Fibre Channel switches used to access the direct-attached Fibre Channel drives in the library can use failover software to provide redundant connectivity through the two Fibre Channel ports on each full-height drive

Exporting Controller Redundancy

You can select multiple RIMs as controllers for a single partition, and export the same changer interface over them to provide redundancy, as long as your data storage software can support this.

Drive Connectivity Failover

The drives used with the library are equipped with two Fibre Channel or SAS ports. The two ports cannot be used simultaneously to provide redundant data paths between the hosts and the drive. However, they can be used to provide failover capability in the event that communication to the port currently in use is interrupted. This failover can be accomplished several ways, including:

- Manually disconnect the cable from the failed port and connect it to the other port. You may need to reconfigure your host software to recognize the alternate port.
- Connect each port on the drive to a separate HBA port in the host. Configure one HBA port as the primary connection and the other HBA port as the failover connection. Install failover software on the host computer to control the transfer of I/O from one HBA to the other in case of a failure.

Note: You may also need to configure your storage management software to correctly recognize both ports. Refer to your failover software, HBA, and storage management software documentation for instructions.

Note: Tape drives sold by Spectra Logic do not support MPIO.

Robotics Failover

The standard library configuration includes dual robotic TeraPorters. During normal operation, each TeraPorter operates independently. The library software manages the TeraPorters to ensure that they perform as efficiently as possible and do not interfere with each other.

In the event that one of the TeraPorters experiences a problem, the TeraPorter automatically moves into service position, and the other TeraPorter takes over all media move operations. In the event that the malfunctioning TeraPorter is unable to move itself into its service position, the other TeraPorter pushes it into the service position.

Redundant Power Supplies

The library requires 5/12 VDC to power the drives. The number of power supplies required by a library is calculated based on the number and type of drives in the library. Extra power supplies provide redundancy and failover protection.

The library main frame requires one 24 VDC power supply to provide power for the library robotics, motors, fans, and interior LED panels. An additional 24 VDC supply can be installed to provide redundancy.

The main frame and each drive frame have both a primary and a secondary AC power input. When using a redundant AC power configuration, each input for a frame is connected to a separate branch circuit, which allows for failover in the event of a power failure in one of the circuits.

- When using a dual AC power module, the two AC inputs for each frame must be on the same phase, and the voltages must be the same within a few volts.
- The dual AC 2 does not require the power sources for the AC inputs for a frame to be on the same phase. See [Input Power Requirements](#) for more information.

**CAUTION**

If the power sources for the AC inputs for a frame using the dual AC or dual AC with convenience outlets are not on the same phase, damage to the library could result. This does not apply to a frame using the dual AC 2.

CHAPTER 4 - CONFIGURING THE LIBRARY

This chapter describes configuring the T950 library, including creating partitions.

| | |
|--|------------|
| Configuring Users | 72 |
| Creating and Editing Users | 73 |
| Editing the Current User Password | 74 |
| Configuring Settings | 75 |
| Basic Settings | 76 |
| Auto-Logout Settings | 77 |
| Authentication Settings | 77 |
| Network Settings | 80 |
| Syslog and Remote Client Settings | 81 |
| Power Settings | 82 |
| Barcode Settings | 83 |
| Dashboard Settings | 84 |
| Partition Overview | 85 |
| Licensing | 85 |
| Configuring and Using Cleaning Partitions and Auto Drive Clean | 85 |
| Configuring and Using Storage Partitions | 86 |
| Storage Partition Options | 86 |
| Creating A Partition | 89 |
| Overview | 89 |
| Partition Interface | 89 |
| Creating A New Cleaning Partition | 90 |
| Creating A New Storage Partition | 91 |
| Modifying An Existing Partition | 99 |
| Deleting A Partition | 101 |

CONFIGURING USERS

Overview

Each library user is assigned to one of three user groups, each with its own set of pre-defined library privileges.

Understanding User Groups and Security

The following table describes the three user groups and the privileges of each.

| User Group Type | Description |
|----------------------|---|
| Superuser | <p>Controls all aspects of the library's configuration and operation, including defining other library users and assigning them to a user-privilege group. By default, the LumOS software has a superuser account named "su".</p> <p>Notes:</p> <ul style="list-style-type: none"> • The library requires a minimum of one superuser. You cannot delete the last member of the superuser group. • Only a user with superuser privileges can add, modify, or delete users. • Only a user with superuser privileges can access and configure encryption features. |
| Administrator | <p>Configures and uses the library. Users in the Administrator group have the same privileges as users in the superuser group with the exceptions of creating or modifying library users, accessing the encryption features, changing authenticators, restoring the library from a backup, or reading the security log.</p> |
| Operator | <p>Performs day-to-day operations. Users assigned to the Operator group can move media, and import and export media using the Entry/Exit pool, but cannot access the more sensitive library operations such as configuration, diagnostics, and security.</p> |

Creating and Editing Users

This section describes using the LumOS user interface to create and edit users. To begin, login to the LumOS user interface and navigate to **Configuration > User Management**.

The screenshot shows the LumOS Users management interface. At the top, there is a 'SPECTRA' logo, a 'Users' dropdown menu, and a 'LOG OUT' button. The main content is divided into two sections: 'Create User' and 'All Users'.

Create User Section:

- Username:** A text input field containing 'Test User'. A note below it says 'Choose an unused username'.
- User Group:** A dropdown menu currently set to 'Admin'.
- New Password:** A password input field with masked characters (dots).
- Confirm New Password:** A second password input field for confirmation.
- Partitions:** A row of checkboxes for 'LTO Storage Partition', 'LTO6 Storage Partition', 'LTO7 Storage Partition', 'LTO8 Storage Partition', 'LTO9 Storage Partition', and 'LTO Clean Partition 1'.
- CREATE USER:** A prominent black button at the bottom of the form.

All Users Section:

| Username | User Group | Partitions | Change Password | Delete User | |
|-------------------------------------|------------|------------|------------------------|--|---------------------------------------|
| <input checked="" type="checkbox"/> | OP | Operator | LTO8 Storage Partition | <input type="button" value="CHANGE PASSWORD"/> | <input type="button" value="DELETE"/> |
| <input type="checkbox"/> | su | Super User | | <input type="button" value="CHANGE PASSWORD"/> | <input type="button" value="DELETE"/> |

At the bottom of the 'All Users' section, there is an 'Update Action' dropdown menu set to 'Change User Group', a 'Group' dropdown menu set to 'Admin', and an 'UPDATE SELECTED USERS' button.

Figure 26 The LumOS Users screen.

Use Figure 26 above to help you create and edit users.

1. Enter the required information for **Username**, **User Group**, **Password**, and **Confirm Password**.

Valid user groups are **Operator**, **Admin**, and **Superuser**.

Note: Usernames are case sensitive.

2. Select the partition(s) you want to assign to the new user.

Note: Users can only access the partition(s) assigned to them.

3. Click **Create User**. The new user displays below in the **All Users** section.

4. Click **Change Password** and enter and confirm a new password if desired.
5. To edit a user, select one or more users in the **All Users** section. Select the desired action from the **Update Action** drop-down menu and then an option from the **Please Choose an Update Action First** drop down menu.

Note: Valid update actions include under **Update Action** are:

- **Add Partition Access**
- **Remove Partition Access**
- **Change User Group**

6. Click **Update Selected Users**.

Editing the Current User Password

This section describes using the LumOS user interface to edit the password for the user profile actively signed on to the library.

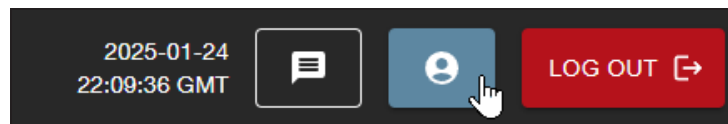

Figure 27 The LumOS toolbar buttons.

1. Click on the blue user icon in the top right to open the current user settings.

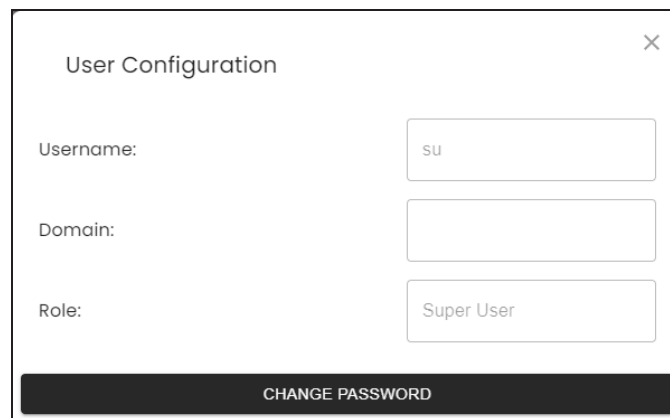

Figure 28 The LumOS User Configuration screen.

2. Click **Change Password**.
3. Enter the current user password, the new desired password, and confirm the new desired password.
4. Click **Submit**.

CONFIGURING SETTINGS

You can use the LumOS user interface to configure settings for the T950 library. This section describes configuring all settings in the Settings screen in these sections:

- **Basic Settings on the next page**
- **Auto-Logout Settings on page 77**
- **Authentication Settings on page 77**
- **Network Settings on page 80**
- **Syslog and Remote Client Settings on page 81**

To begin, log in to the LumOS user interface and select **Configuration > Settings**.

Basic Settings

Basic Settings

Name 1

Contact 2

Location 3

Manual 4
 NTP

Date & Time (Location: America/Los_Angeles)

mm/dd/yyyy --:-- -- 📅

Front Panel Time Zone

UTC 5 ▼

Figure 29 The Basic Settings section.

1. Enter a **Name** for the T950 library.
2. Enter **Contact** information for the library.
3. Enter **Location** information for the library.
4. Select between **Manual** or **NTP** for the time format on the library.
 - If you select **Manual**, enter the required time and date information or click the calendar icon on the right hand side to set the time.
 - If you select **NTP**, enter the required NTP server information for up to four NTP servers (not pictured).
5. Select the **Front Panel Time Zone** in the drop-down menu.
6. Click **Submit Changes** (not pictured).

Auto-Logout Settings

This section covers the available auto-logout settings for the LumOS user interface. All entry field text must be numerical.

Automatic Logout Settings

Refresh Timeout (in seconds) 1

86400

Length of time, in seconds, that a token can be refreshed. If set to zero, tokens can be refreshed indefinitely, as long as the current access token is valid.

Token Lifetime (in seconds) 2

900

Length of time, in seconds, that an access token is valid. The minimum value for this is 60.

Figure 30 The Auto-Logout section.

1. Enter a value for the **Refresh Timeout**. This setting is the length of time in seconds that you can refresh a token. If set to zero, you can indefinitely refresh a token provided a valid and current access token.
2. Enter a value for the **Token Lifetime**. This setting is the length of time in seconds that an access token is valid. The minimum value is 60 seconds.

Authentication Settings

This section covers all the available authentication settings in the LumOS user interface.

Authenticators

New Authenticator Name 1

New Authenticator 2 3

NEW LDAP AUTHENTICATOR NEW NATIVE AUTHENTICATOR

Figure 31 The Authenticator sections.

1. Enter a **New Authenticator Name**.
2. Click **New LDAP Authenticator** to create a new LDAP (Lightweight Directory Access Protocol) Authenticator. See the LDAP Authenticator subsection [on the next page](#) to learn how to configure a LDAP authenticator.
3. Click **New NATIVE Authenticator** to create a new NATIVE Authenticator. See the NATIVE Authenticator subsection [on page 79](#) to learn how to configure a native authenticator.

LDAP Authenticator

This section covers the available LDAP authentication settings in the LumOS user interface.

Figure 32 The LDAP Authenticator section.

1. Toggle the selector to enable the LDAP authenticator.
2. Enter the required information for the **Read Only User** username, **Read Only Password**, the **Base DN** (domain name) information, **Username Key**, and **Groups Key**.
3. Toggle the selector to enable **Trusted Certificate** if desired.
4. Enter information for the **Port**, **Superuser Group**, and **Admin Group**.
5. Enter information for the **Operator Group**.
6. Click **Submit Changes**.

NATIVE Authenticator

This section covers the available NATIVE authentication settings in the LumOS user interface.

Note: The library only supports one NATIVE authenticator.

The screenshot displays the 'Settings' page for the 'NATIVE Authenticator Example authenticator (NATIVE)'. The interface includes a header with the 'SPECTRA' logo and a dropdown arrow. Below the header, the authenticator name is shown, followed by a 'DELETE' button. A toggle switch labeled 'Enabled' is set to 'On'. A red box highlights the password requirements section, which includes fields for:

- Minimum Numbers: 2
- Minimum Uppercase: 1
- Minimum Lowercase: 3
- Minimum Special Characters: 1 (circled with a '2')
- Minimum Password Length: 8
- Password History Length: 5
- Maximum Repeated Characters: 2

 Below this section, the 'Enable Password Expiration' checkbox is checked (circled with a '3'). Underneath, there are three more fields:

- Password Lifetime (in seconds): 86400
- Minimum Password Age (in seconds): 60 (circled with a '4')
- Expiration Warning (in seconds): 604800

 A red button labeled 'SUBMIT CHANGES' (circled with a '5') is located at the bottom right of the settings area.

Figure 33 The NATIVE authenticator section.

1. Toggle the selector to enable the NATIVE authenticator.
2. Enter the desired password requirements in the entry fields.
3. Select **Enable Password Expiration** if desired.
4. Enter the desired password expiration settings in the entry fields.
5. Click **Submit Changes**.

Network Settings

This section covers configuring Network Settings.

The screenshot shows the 'Network Settings' configuration interface. It is divided into sections for IPv4, IPv6, Port, and DNS Servers. Red boxes and numbered circles (1-5) highlight specific elements:

- 1:** A red box around the DHCP dropdown menu for IPv4.
- 2:** A red box around the IPv4 address input field.
- 3:** A red box around the default gateway input field for IPv4.
- 4:** A red box around the port number '443' and the 'POPULATE DEFAULT PORT' button.
- 5:** A red box around the first of three DNS server input fields.

Figure 34 The Network Settings screen.

1. Toggle the drop-down menu between **DHCP** and **Static** as desired.
2. Enter information for the **Network** address.



IMPORTANT IPv4 and IPV6 IP addresses must be entered in CIDR format.

3. Enter information for **Default gateway**.
4. Enter information for **Port**. Click **Populate Default Port** if desired.
5. Enter information for **DNS Servers** if desired. You may enter up to three DNS servers.
6. Click **Submit Changes** (not pictured).

Syslog and Remote Client Settings

This section covers configuring the Syslog and Remote Client settings.

Syslog Settings

1

Syslog Remote Server

Enter a hostname or IP address. Do not include a port number or subnet mask.

Remote Client Settings

2

Import/Export Allowed for Remote Clients

3

SUBMIT CHANGES

Figure 35 The Syslog Settings and Remote Client Settings sections.

1. Enter information for the **Syslog Remote Server**. You can enter an IP address or hostname for the remote syslog server.

Note: Syslog on Spectra LumOS uses UDP and the port 514.

2. Select **Import/Export Allowed for Remote Clients** to allow remote clients to prepare Import/Export actions. You still require physical access to the library to move the cartridges inside the TAP.
3. Click **Submit Changes**.

Power Settings

This section covers configuring the LumOS power settings.

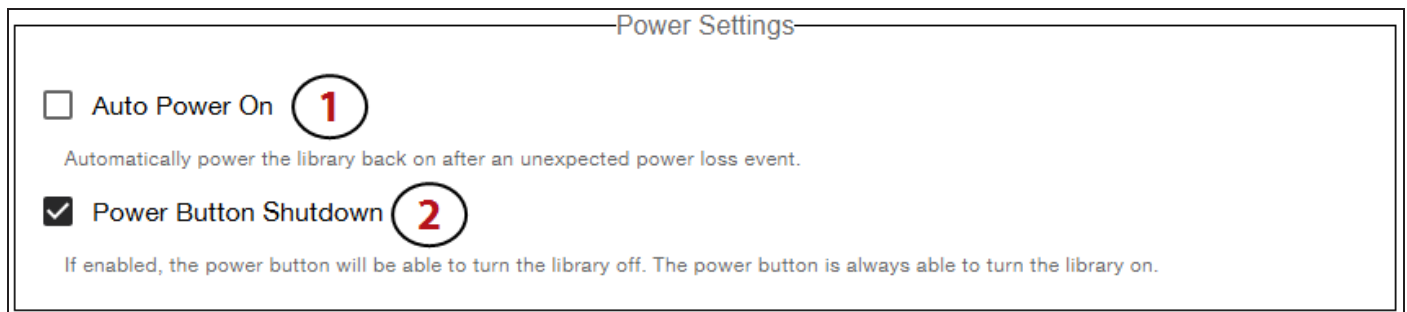

Power Settings

Auto Power On **1**
Automatically power the library back on after an unexpected power loss event.

Power Button Shutdown **2**
If enabled, the power button will be able to turn the library off. The power button is always able to turn the library on.

Figure 36 The Power Settings section.

1. Select **Auto Power On** to automatically power the library after an unexpected power loss event.
2. Select **Power Button Shutdown** to allow users to press the library power button to turn the library off.
3. Click **Submit Changes** (not pictured).

Barcode Settings

This section covers configuring the LumOS barcode settings.

Barcode Options

Barcode options determine how tape barcodes are reported over LumOS and to hosts.

Use Checksum: Your labels include a checksum and you want the barcode verified against the checksum when it is read. Verification is not generally required, but adds extra confirmation that the barcode label was read correctly by the barcode reader.

No Checksum: Your labels do not include a checksum.

Ignore Checksum: Your labels include a checksum character but you do not want the barcode verified against the checksum when it is read.

Left: Truncate the left side and report only the right-most n number of characters in the barcode.

Right: Truncate the right side and report only the left-most n number of characters in the barcode.

For example, if the tape barcode is 1234567L2, truncate right with a length of 5 will report the barcode as 12345.

Checksum Behavior

1 Ignore Checksum

▼

2 Left

16

3

Truncation Side

Number of Characters to Report

Figure 37 The Barcode Settings section.

1. Use the **Checksum Behavior** drop-down menu to select between **Use Checksum**, **No Checksum**, and **Ignore Checksum**.
2. Use the drop-down menu to select the **Truncation Side**.
3. Enter a number into modify the **Number of Characters to Report**.
4. Click **Submit Changes** (not pictured).

Dashboard Settings

This section covers configuring the LumOS dashboard setting.

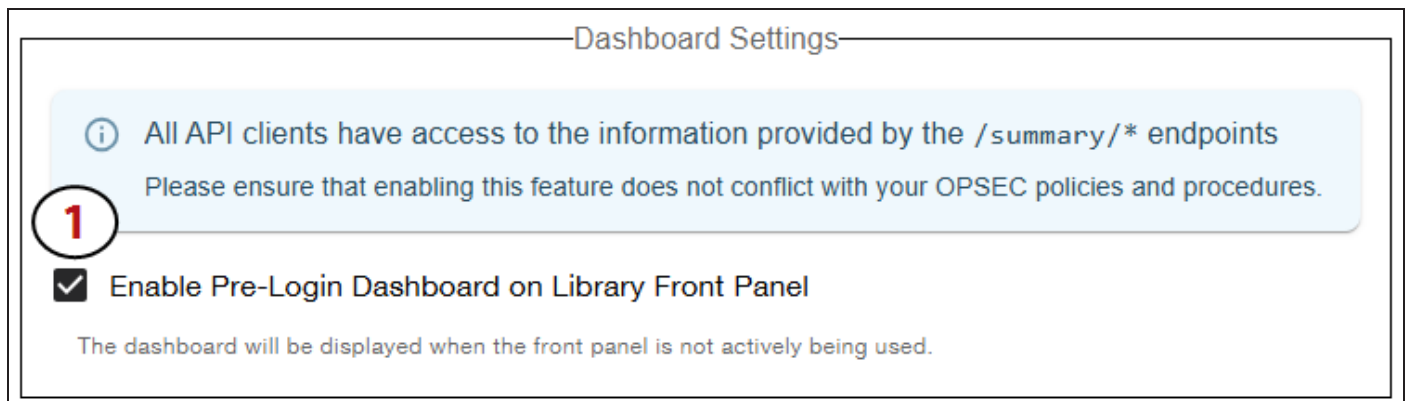

Figure 38 The Dashboard Settings section.

1. Select **Enable Pre-Login Dashboard on Library Front Panel** to display the pre-login dashboard screen on the library front panel.
2. Click **Submit Changes** (not pictured).

PARTITION OVERVIEW

The library supports two types of partitions: storage partitions and cleaning partitions. When configuring partitions, keep in mind the requirements in the following sections.

Licensing

By default the library allows you to create a single cleaning partition and a single storage partition using five storage chambers total. Additional partitions and storage chambers are available through purchasable licenses. Contact Spectra Logic to purchase additional licenses for your library. See [Licenses on page 147](#) for information on entering a purchased license key into the library.

Configuring and Using Cleaning Partitions and Auto Drive Clean

- Cleaning partitions do not count against the partition maximum.
- A cleaning partition can be shared by multiple storage partitions as long as the cleaning cartridges are compatible with the drive types in each storage partition.
- Cleaning partitions use chambers that are not licensed with a Capacity On Demand (CoD) key. If all of the chambers are licensed, a cleaning partition uses any chambers that are not already assigned to another partition.
- Configuring a cleaning partition and assigning it to one or more storage partitions automatically enables the Auto Drive Clean feature for those storage partitions. The drives in the storage partitions with an associated cleaning partition are cleaned automatically when a drive indicates that it needs cleaning.
- The cleaning cartridges in the cleaning partition are inaccessible to the storage management software. If your storage management software supports automated drive cleaning and you plan to use this method to clean the drives, store a TeraPack magazine (not a Maintenance TeraPack magazine) containing one or more cleaning cartridges in the storage partition's storage pool. The storage management software can then access the cleaning cartridges when needed.



IMPORTANT

If you store cleaning cartridges in the storage partition, make sure that they are identified as required by your storage management software to prevent the storage management software from attempting to use the cartridges for writing or reading data.

- The cleaning cartridges used in a cleaning partition must be stored in specially labeled Maintenance TeraPack magazines.

- If you do not configure a cleaning partition and associate it with the storage partitions, you must use your storage management software to perform the cleaning or use the LumOS user interface to manually move a cleaning cartridge to the drive that needs cleaning.
- Media moves initiated from the front panel or REST API commands do not trigger drive auto cleaning.

Configuring and Using Storage Partitions

- You can configure storage partitions either before or after you configure cleaning partitions. If you want to use Auto Drive Clean with a storage partition, it is easier to configure the cleaning partition before you configure the storage partition. If you choose to create the storage partition before you create the cleaning partition, you need to modify the storage partition to assign the cleaning partition to it.
- The library requires, at a minimum, one storage partition to be configured before you can use the library. Each storage partition must have a minimum of one drive and one chamber assigned to the storage pool.
- When using multiple tape technologies, Spectra Logic strongly recommends configuring separate partitions for each technology.
- When using both Fibre Channel and SAS drives in the library, the different drive interface types must be in separate partitions.
- Chamber Availability — The number of chambers available for a storage partition depends on how many chambers in the library are licensed and how many chambers are used by other partitions.
Note: The more partitions in a library, the longer each move can take. If move requests can be sent to several partitions at once, you may need to increase the timeout setting in your storage management software.
- Restrictions on Exporters — Each partition is exported by a RIM2 or drive.
 - a single RIM2 can export up to 16 partitions, but still only count as one exporter.
 - If desired, you can configure multiple exporting RIM2 controllers to a single partition and use your host software to export the same changer interface over the controllers to provide redundancy.

Storage Partition Options

Before you begin configuring partitions, gather the information listed in the following table.

| Option | Description |
|----------------------------|--|
| Soft Load | The Soft Load feature uses the drive's soft load (or auto load) functionality to improve library performance. Soft Load requires that the library have high performance transporters. |
| MLM Discovery | <p>Choose the MLM discovery options for the partition.</p> <ul style="list-style-type: none"> • Disabled - Prevent the partition from populating in the MLM database. • Auto Discovery - Automatically add newly imported cartridges to the MLM database. • PreScan - Automatically add newly imported cartridges to the MLM database. Additionally checks the cartridge to determine if it has any of the following characteristics: <ul style="list-style-type: none"> • Non-MLM-enabled • Broken or dislodged leader • Write protected • Encrypted tape with a moniker not currently stored in the library • Red media health |
| Read Element Status | <p>Read Element Status returns the status of elements in the partition.</p> <ul style="list-style-type: none"> • Standard - The default setting. • Tape Generation - Adds Media Domain, Media Type, Drive Domain, and Drive Type to the SCSI command response. |
| SlotIQ | SlotIQ optimizes robotics performance by allowing the library to virtualize slot locations and optimize the order of moves in a queue to reduce the amount of robotic movement required for any set of moves. |
| Quick PostScan | <p>Quick PostScan performs a readability verification test to verify data integrity for all of the cartridges in the partition. Quick PostScan verifies all the data on a single wrap from the beginning of the tape (BOT) to the end of the wrap or end of recorded data (EOD), whichever comes first.</p> <p>Note: Quick PostScan is only supported for Spectra Certified Media, and only for tape cartridges in storage slots. Tape cartridges in drives or Entry/Exit slots are not scanned.</p> <p>Note: Media moves initiated from the front panel or REST API commands do not trigger PostScan operations.</p> |
| Barcode | <p>Choose the barcode label options for the partition. Spectra Certified data cartridges with standard barcode labels use a barcode with eight human-readable characters followed by a checksum character that is not human-readable.</p> <p>Barcode options allow the user to set the checksum behavior, truncation side, and the number of characters to report.</p> |

| Option | Description |
|--------|---|
| | <ul style="list-style-type: none">• Checksum Behavior - The library supports three different checksum behaviors. Use Checksum (default) verifies the barcode against the checksum during a read. Ignore Checksum does not verify the barcode against the checksum. If your labels do not include a checksum, use No Checksum.• Truncation Side - Truncates barcode characters in the library. The library supports Left and Right side truncation.• Number of Characters to Report - Select the number of barcode characters to report. If Number of Characters to Report is set to a lower number than 16, the library truncates characters on the side configured by Truncation Side. <p>IMPORTANT Be careful when specifying the number of characters to report. You may end up with duplicate barcodes reported. For example, 12345XXXL2 and 12345ABCL3 are both reported as 12345 with a right side truncation of 5 characters.</p> |

CREATING A PARTITION

Overview

The LumOS user interface allows the user to create a new partition on the T950 library. This section covers [Creating A New Storage Partition on page 91](#) and [Creating A New Cleaning Partition on the next page](#).

Partition Interface

Log into the LumOS user interface and select **Configuration > Partition**. The Partitions screens displays.

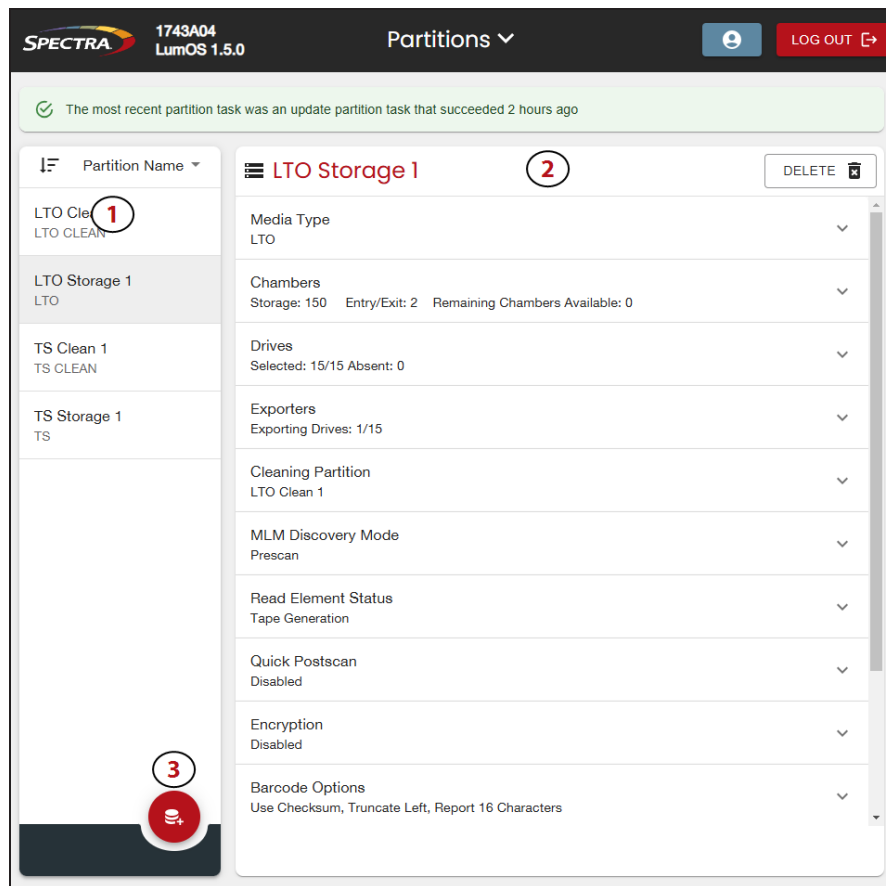

Figure 39 The LumOS partitions screen.

Features of the Partitions screen include:

- Partition Tab (1) - Displays all existing partitions. The filter sorts the list by Partition Name or Media Type.
- Partition Management Tab (2) - Displays the information about the selected partition.
- Create New Partition button (3) - Opens the wizard to create a new partition.

Creating A New Cleaning Partition

The following section describes the steps to create a new cleaning partition. The step numbers relate to the numbered locations on the figure below.

Figure 40 The LumOS cleaning partition creation screen.

1. Click the **New Partition** button. Enter the name for the new cleaning partition and click **Begin Cleaning Partition Creation**. The cleaning partition creation section displays.

Note: Only alphanumeric characters are allowed for the partition name.
2. Select the **Media Type** you want to use. Cleaning partition media type must match the storage partition media type.
3. Use the **Storage** entry field or slider to select the number of chambers for the partition.
4. Select the desired **Checksum Behavior** using the drop-down menu. You may specify the **Truncation Side** using the drop-down menu, and the number of characters using the slider.
5. Click **Create Cleaning Partition**.

Creating A New Storage Partition

The following section describes the steps to create a new storage partition. The step numbers correspond to the numbered locations on the figures below. Start by clicking the **New Partition** button and entering the name for the new storage partition.

Note: Only alphanumeric characters are allowed for the partition name.

Click **Begin Storage Partition Creation**. The storage partition creation section displays.

Note: The Partition name cannot be edited in the future.

The screenshot shows the 'Test' storage partition creation interface. It is divided into two main sections: 'Media Type' and 'Chambers'.
 1. The 'Media Type' section features a drop-down menu currently set to 'LTO'. A red circle with the number '1' is positioned above the menu.
 2. The 'Chambers' section contains two sliders for resource allocation. The top slider is for 'Storage', with a value of 0 and 210 available. The bottom slider is for 'Entry/Exit', also with a value of 0 and 210 available. A red circle with the number '2' is positioned above the 'Storage' slider.
 A light blue information box on the left of the 'Chambers' section states: 'Slots are allocated to partitions on a chamber basis. At least one storage chamber must be allocated.'

Figure 41 The LumOS storage partition creation screen - Media Type and Chambers.

1. Use the **Media Type** drop-down menu to select between LTO and TS drives.

Note: Media type cannot be changed after creation.

2. Use the entry fields or sliders to select the number of **Storage** chambers and **Entry/Exit** chambers for the partition.

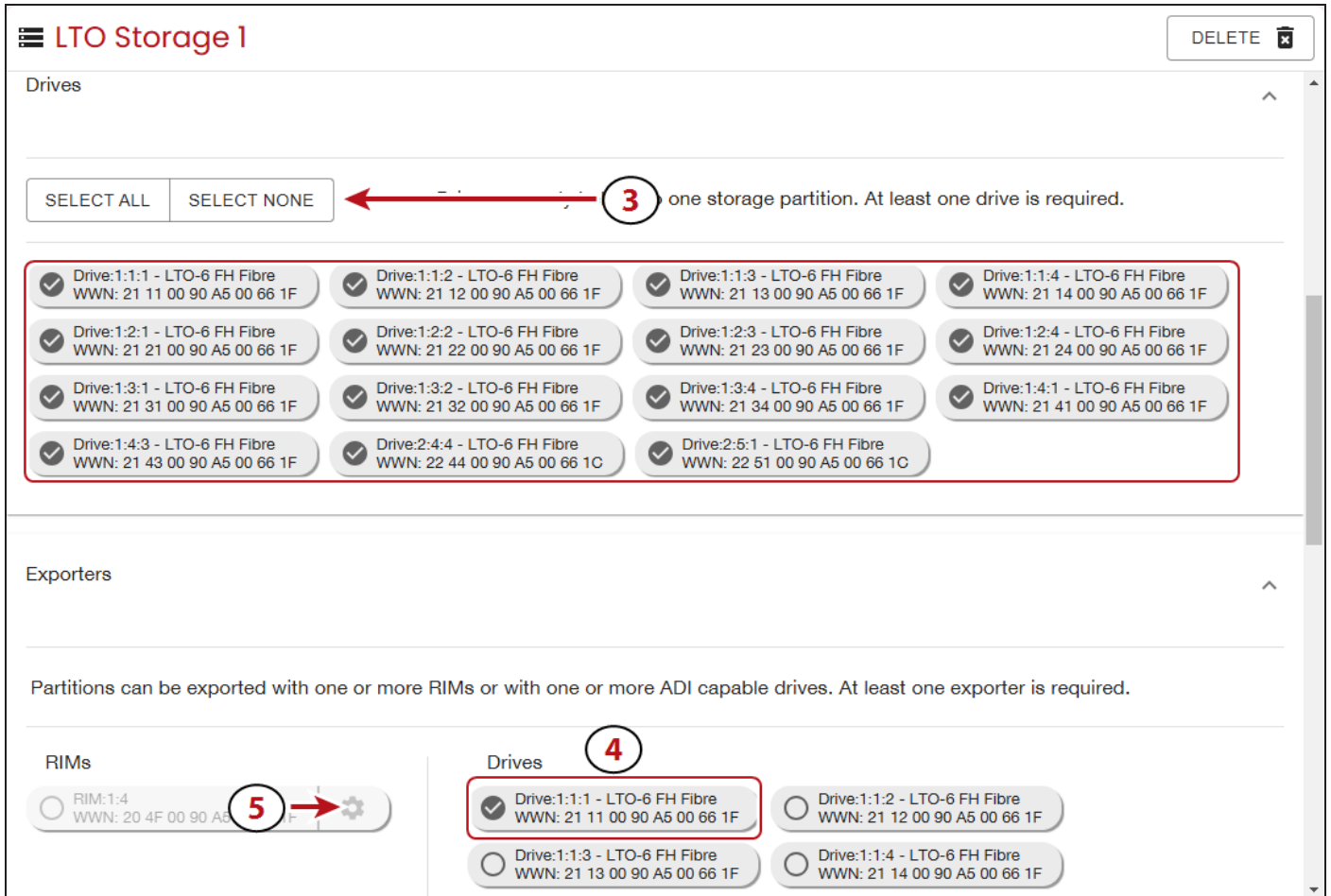

Figure 42 The LumOS storage partition creation screen - Drives and Exporters.

3. Select the **Drives** to include in the partition. At least one drive is required to create a partition.
4. Select any desired RIM2s or drives selected in Step 3 as an **Exporter**. At least one exporter is required to create a partition.
5. Click the **Gear Icon** next to a RIM2 to configure the RIM2 settings.

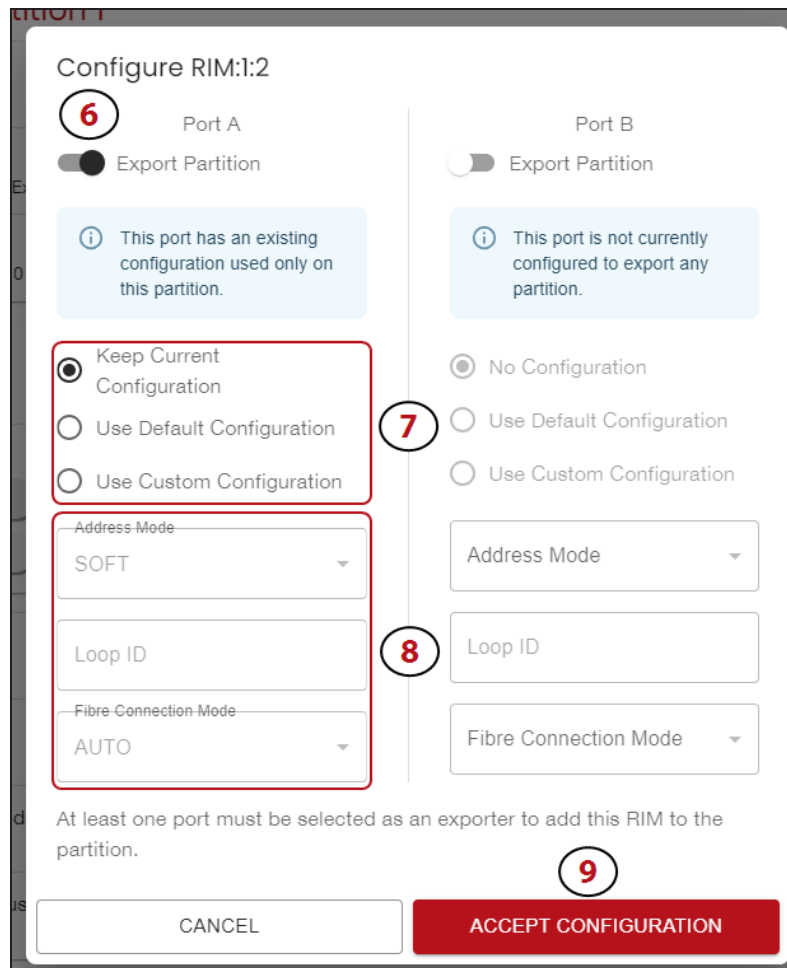

Figure 43 The LumOS storage partition creation screen - RIM2 configuration.

6. Use the selector to configure **Port** for the partition. At least one port must be selected as an exporter to add the RIM2 to the partition.

Note: If a RIM2 port is configured for multiple partitions, the RIM2 port configuration is shared across all shared partitions.
7. Select a configuration type. If you select Use Custom Configuration, continue to Step 8 on page 93. Otherwise, skip to Step 9 on page 93.
8. If you selected **Use Custom Configuration**, use the drop-down menu to select an **Address Mode**, enter a **Loop ID** in the entry field, and select a **Fibre Connection Mode** from the drop-down menu.
9. Click **Accept Configuration**.



Figure 44 The LumOS storage partition creation screen - Cleaning Partition and MLM Discovery Mode.

- 10.** If desired, select a **Cleaning Partition**. Cleaning partitions must use the same media type as the storage partition.
- 11.** If desired, use the selector to enable **SoftLoad**.
- 12.** Select **MLM Discovery Mode**. Available options are **Auto Discovery**, **PreScan**, **Passive**, and **Disabled**.
 - **Auto Discovery** discovers newly imported cartridges and adds them to the MLM database.
 - **PreScan** discovers newly imported cartridges, adds them to the MLM database, and additionally runs a basic health and function test on the tape cartridge.
 - **Passive** does not discover new imported cartridges, but does add tape cartridge information to the MLM database when the tape cartridge is unloaded from a drive.
 - **Disabled** prevents the tape cartridges in the partition from populating to the MLM database.

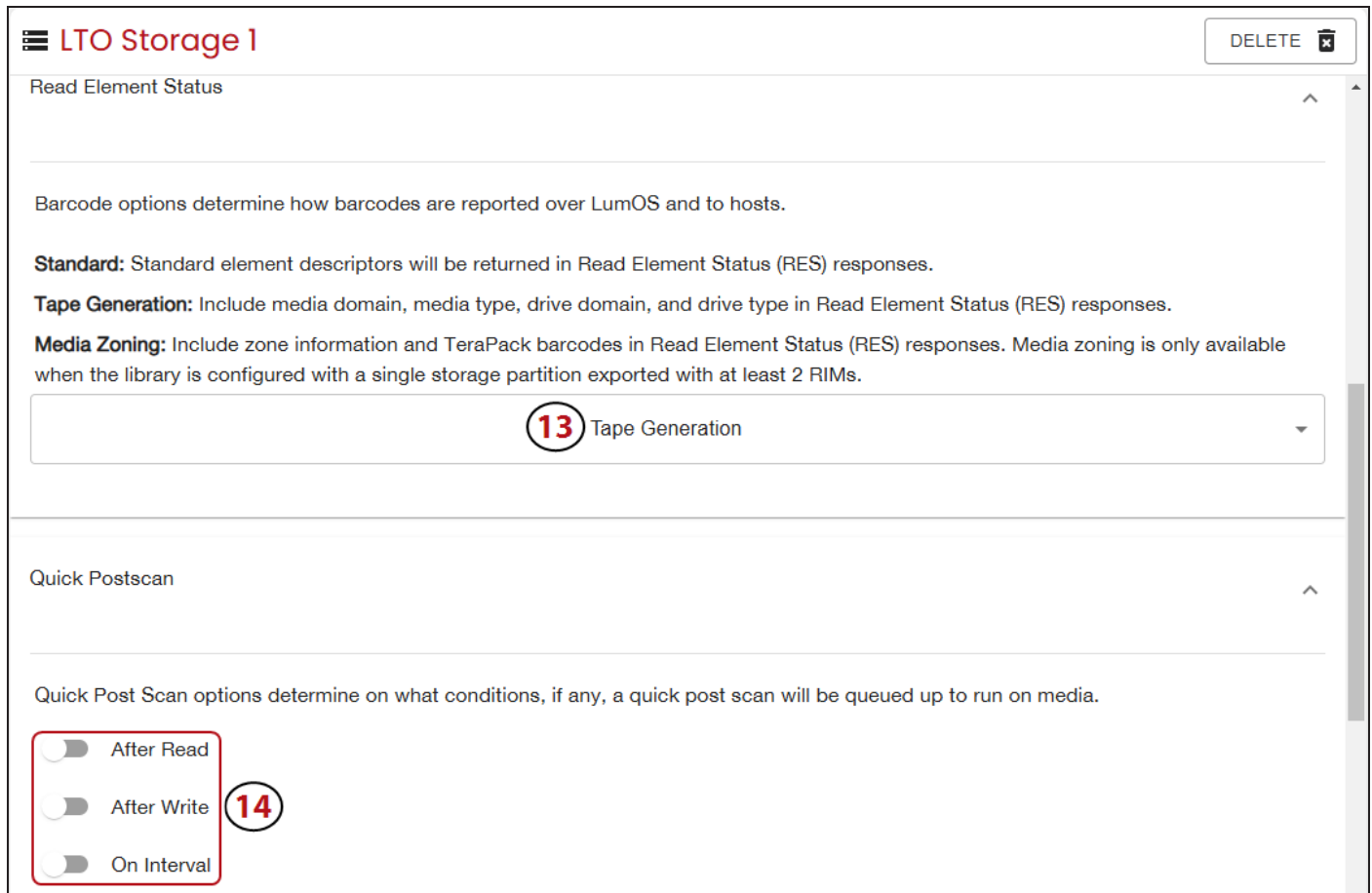

Figure 45 The LumOS storage partition creation screen - Read Element Status Options and Quick PostScan.

13. Use the **Read Element Status Options** drop-down menu to select between **Standard**, **Media Zoning**, and **Tape Generation** options.

14. Use the selectors to configure the **Quick PostScan** frequency. If you select **On Interval**, enter a value in the entry field to indicate the number of days between scans.

Note: Media moves initiated from the front panel or REST API commands do not trigger PostScan operations.

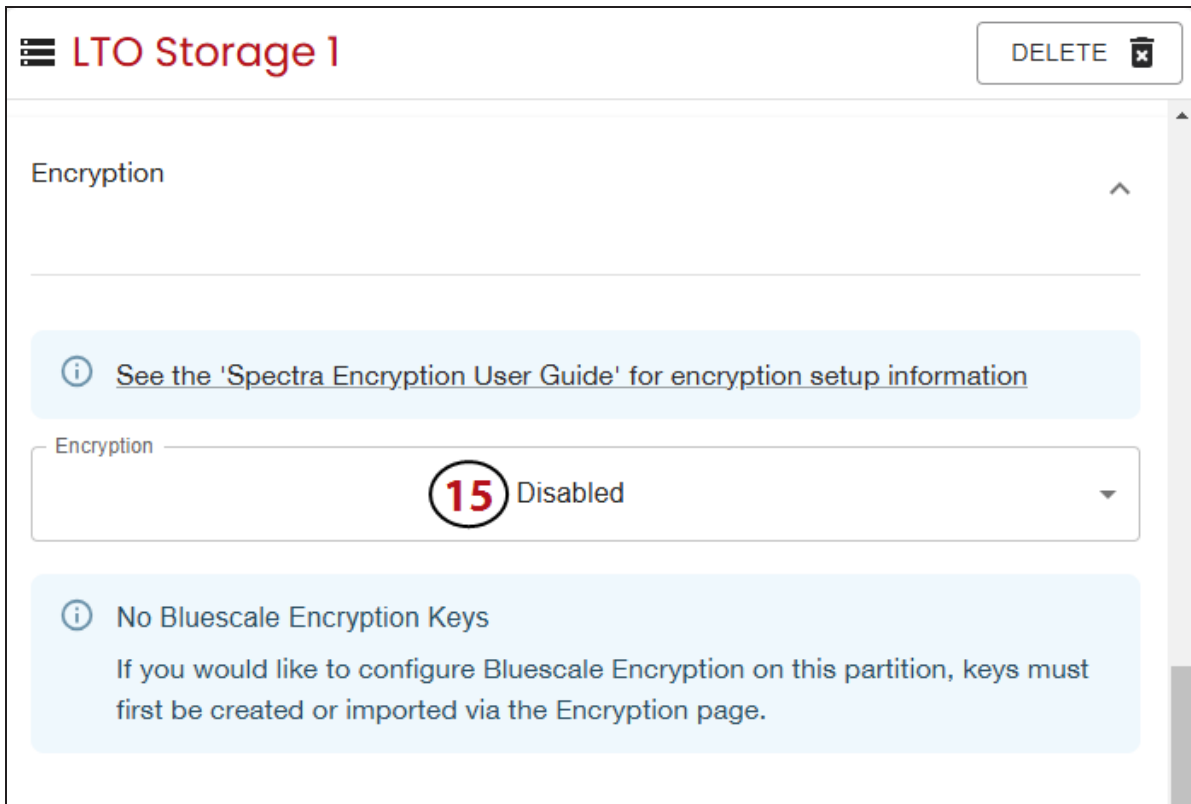

Figure 46 The LumOS storage partition creation screen - Encryption Options.

15. If desired, use the drop-down menu to select an **Encryption** type. Available options are **Disabled**, **BlueScale Encryption**, and **KMIP**. If you select to use encryption, use the **Encryption Key** drop-down menu to select an existing key. For more information on how to add an encryption key, see [Configuring Encryption on page 105](#).

LTO Storage 1 DELETE

Barcode Options ^

Barcode options determine how barcodes are reported over LumOS and to hosts.

Use Checksum: Your labels include a checksum and you want the barcode verified against the checksum when it is read. Verification is not generally required, but adds extra confirmation that the barcode label was read correctly by the barcode reader.

No Checksum: Your labels do not include a checksum.

Ignore Checksum: Your labels include a checksum character but you do not want the barcode verified against the checksum when it is read.

Left: Truncate the left side and report only the right-most n number of characters in the barcode.

Right: Truncate the right side and report only the left-most n number of characters in the barcode.

For example, if the barcode is 1234567L2, truncate right with a length of 5 will report the barcode as 12345.

16 Use Checksum

Checksum Behavior

17 Truncation Side

16 **18** Number of Characters to Report

Figure 47 The LumOS storage partition creation screen - Checksum Options.

- 16.**For Barcode Options, use the **Checksum Behavior** drop-down menu to select between **Use Checksum**, **No Checksum**, or **Ignore Checksum**.
- 17.**Use the drop-down menu to select the **Truncation Side**.
- 18.**Enter a number into modify the **Number of Characters to Report**.

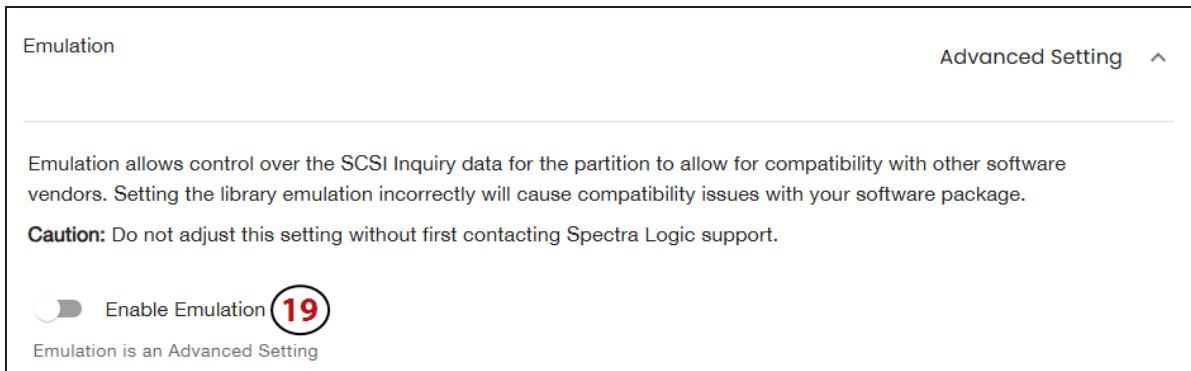

Figure 48 The LumOS storage partition creation screen - Emulation Options.

19. If desired, use the selector to enable **Emulation**. If you select to use emulation, enter **Vendor** and **Product** information in the required fields.

Note: Contact Spectra Logic Technical Support before modifying this setting.

20. Click **Create Storage Partition** at the bottom of the screen (not shown).

MODIFYING AN EXISTING PARTITION

This section describes how to edit or modify an existing partition.

**CAUTION**

Use your storage management software to empty all drives and discontinue host operations before modifying an existing partition.

Preparation

Before making changes to an existing partition, review the information in the [Partition Overview on page 85](#) to ensure that you address any requirements. In addition, consider the following recommendations and requirements:

- Spectra Logic strongly recommends backing up the library configuration, either to a USB device or as an attachment to an email before you make changes.
- When reducing the number of chambers assigned to a partition, physically export any magazines in those chambers before you remove chambers from the partition.

**IMPORTANT**

By default, the library deletes empty chambers from a partition first. However, if all chambers are full, the library is forced to delete populated chambers. When this happens, the magazines in the deleted chambers are no longer accessible through the LumOS user interface. You must add these chambers to either a new or existing partition before the magazines are accessible again.

Modify a Partition

Log into the library as a user with superuser or administrator privileges, then navigate to **Configuration > Partitions**. Use the following figure and corresponding steps to modify an existing partition.

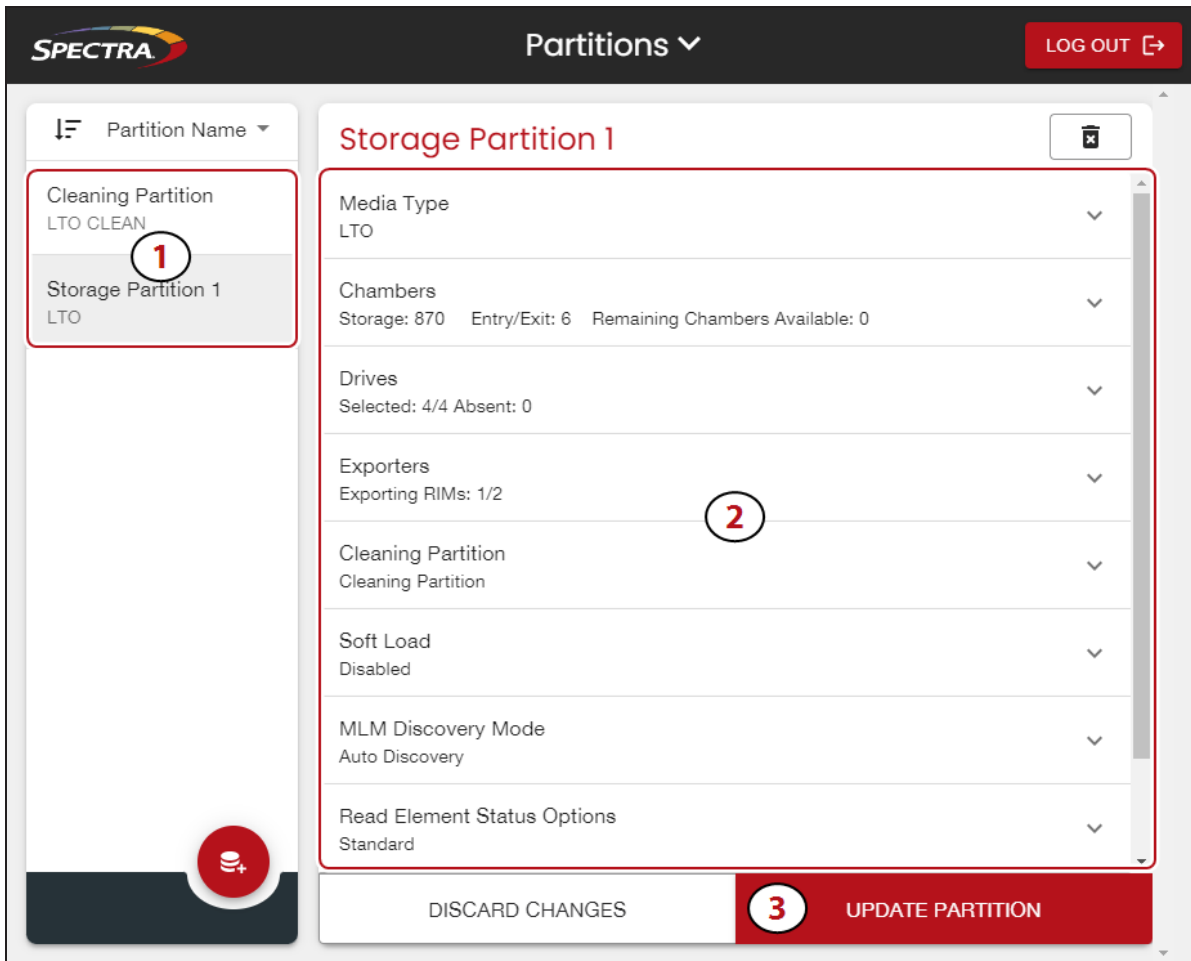

Figure 49 The Partitions screen.

1. Select the partition you want to modify.
2. On the Partition Management Tab, expand the sections you want to modify and make your desired changes. See [Storage Partition Options](#) on page 86 for information about each setting.
3. Click **Update Partition**.

DELETING A PARTITION

When you delete a partition, the drives and chambers previously assigned to that partition are available to be assigned to a new or existing partition.

Preparation

Before deleting an existing partition, make sure you address the following:

- Spectra Logic strongly recommends backing up the library configuration before you delete a partition.
- Empty all drives in the partition.
- To ensure that you do not inadvertently mix cartridges from one storage partition with that from another, use your storage management software to eject all cartridges from the storage partition's storage pool.



IMPORTANT

After the partition is deleted, any magazines in the chambers that were assigned to the partition's storage and entry/exit pools are not accessible until the chambers are assigned to another partition.

- If the storage partition is configured to use encryption, make sure that you export the encryption key for any cartridges that were in the partition.
- If you plan to delete a cleaning partition, remove the cleaning partition from any existing storage partitions, otherwise the delete fails.

Auto Configuration Save

When you delete a partition, the library automatically generates a configuration backup file and saves it to the memory card in the LCM. If you configured the email option, an email with the backup file as an attachment is sent to the specified recipient.

Delete A Partition

Use the following steps to delete an existing partition:

1. Log in as a user with superuser or administrator privileges and navigate to **Configuration > Partitions**.
2. Select the partition you want to delete.
3. Click the trashcan icon in the top right of the Partition Management Tab.
4. Click **Confirm** on the confirmation screen.

CHAPTER 5 - ENCRYPTION

This chapter describes supported encryption methods and how to configure encryption on your T950 library.

| | |
|---|------------|
| BlueScale Encryption Key Management Overview | 103 |
| Understanding the Components | 103 |
| Standard Edition vs. Professional Edition | 103 |
| Configuring Encryption | 105 |
| Adding BlueScale Encryption | 105 |
| Exporting BlueScale Encryption Keys | 108 |
| Deleting BlueScale Encryption Keys | 109 |
| Authorization Settings | 110 |
| Multi User Mode | 112 |
| KMIP Encryption Key Management Overview | 114 |
| Adding KMIP Encryption | 114 |

BLUESCALE ENCRYPTION KEY MANAGEMENT OVERVIEW

BlueScale Encryption key management is tightly integrated into your T950 library. BlueScale Encryption key management is provided through the library's user interface.

Understanding the Components

The BlueScale Encryption key management system contains two major components:

- **The BlueScale Encryption Key management Software** — The key management feature is accessed through the library's user interface, either using the operator panel or a remote connection through the LumOS web interface. Spectra BlueScale encryption key management is available in Standard and Professional Editions to meet your site security requirements.
- **The Encryption Chip in the LTO-6 or Later Generation Drives** — Using encryption-enabled hardware makes encryption extremely fast and places no burden on your network. After encryption is enabled, data is automatically encrypted as it is written to tape.
Note: Encryption-enabled LTO drives use the same encryption algorithm, ensuring that tapes encrypted by one LTO drive generation can be read by another generation of drive as long as the tape itself is compatible with the drive.

Standard Edition vs. Professional Edition

To determine a BlueScale Encryption key management strategy appropriate for your site and your data, decide on the security level required for your site, and the amount and kinds of data to encrypt. After you decide on the appropriate security level and whether data sets need to be isolated, you can decide which edition of BlueScale Encryption meets your needs.

BlueScale Encryption Standard Edition

Standard Edition is included as a standard feature on the library. It is suitable for sites with a primary goal of securing data while it is transported to a remote location and stored there for long-term archival.

BlueScale Encryption Professional Edition

Professional Edition provides additional choices for defining the level of security you implement in your data center. It is suitable for sites that want the added security of multi-password access to the encryption configuration controls and for importing and exporting encryption keys, and the added flexibility of storing up to 30 encryption keys on the library.

The following table compares the major differences between the Standard and Professional Editions.

Note: Subsequent releases will add additional features to BlueScale Encryption Professional Edition.

| Feature | Standard Edition | Professional Edition |
|--|---|---|
| Availability | Included as a standard feature on the library. | Requires a purchased option key to activate. |
| Encryption Login Passwords | Single encryption password accesses all encryption features. | Choose between using one password to access all encryption features or multi user mode. Using the multi user option requires the following: <ul style="list-style-type: none"> • Three unique encryption passwords must be configured. • Two of the three passwords must be entered to enable or disable Secure Initialization mode. • Two of the three passwords must be entered to change authorization settings and to import or export keys. |
| Keys (Data Set Isolation) | <ul style="list-style-type: none"> • Single encryption key stored on the library at a time. • The same key is used for all partitions configured to use encryption. | <ul style="list-style-type: none"> • Up to 30 encryption keys stored on the library. • A single encryption key can be assigned to each storage partition. |
| Key Export and Import | A single password is used when exporting and importing the encryption key. The encryption key is exported in a single file. | A single password is used when exporting and importing the encryption key. The encryption key is exported in a single file. In multi user mode, two of the three configured passwords are required to import or export a key. |
| Compression | Drive-based compression only. | Drive-based compression only. |
| Compatibility between Software Editions | Data encrypted using either software edition (Standard or Professional) can be decrypted by a library running the other edition as long as the key used to encrypt the data is present on the library attempting to decrypt the data. | |

CONFIGURING ENCRYPTION

You can use the LumOS user interface to configure BlueScale and KMIP Encryption for the T950 library. This section describes adding, importing, and exporting BlueScale Encryption, adding a KMIP server and CSR, and how to configure authorization settings.

To begin, log in to the LumOS user interface and select **Configuration > Encryption**.

Adding BlueScale Encryption

Use the figures below to add or import an encryption key.



Figure 50 The Encryption screen.

1. Click **Create Key** or **Import Key**.
 - For **Create Key**, follow Step 2 on page 106.
 - For **Import Key**, follow Step 4 on page 106.

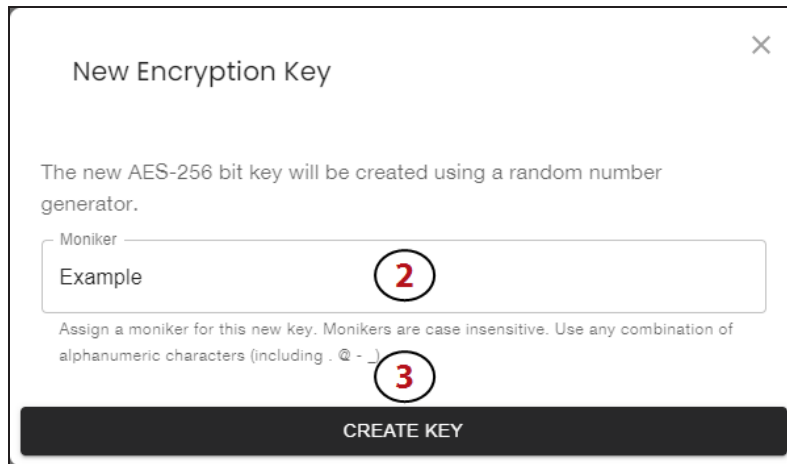

Figure 51 The New Encryption Key screen.

2. To create a new encryption key, enter a **Moniker** in the text field.
3. Click **Create Key**.



Figure 52 The Encryption screen.

4. To import an existing encryption key, click **Import Key** (not pictured) at the bottom of the screen.

Note: If you have a BlueScale Encryption Professional license with Multi User mode enabled, you must first enter two of the three configured Authorization Passwords before proceeding.

Click **Choose File** and use file explorer to locate the desired encryption key file.

5. Enter the **Password** for the selected key into the text field.
6. Click **Import Key**.



Figure 53 The Encryption screen.

7. If you have a BlueScale Encryption Professional license, you can repeat the above steps to create or import additional encryption keys.

Note: To add an encryption key to a partition, see [Creating A New Storage Partition](#) on page 91.

Exporting BlueScale Encryption Keys

Use the figures below to export an existing BlueScale encryption key.



Figure 54 The Encryption screen.

1. Click **Export** next to the desired encryption key.

Note: If you have a BlueScale Encryption Professional license with Multi User mode enabled, you must first enter two of the three configured Authorization Passwords before proceeding.

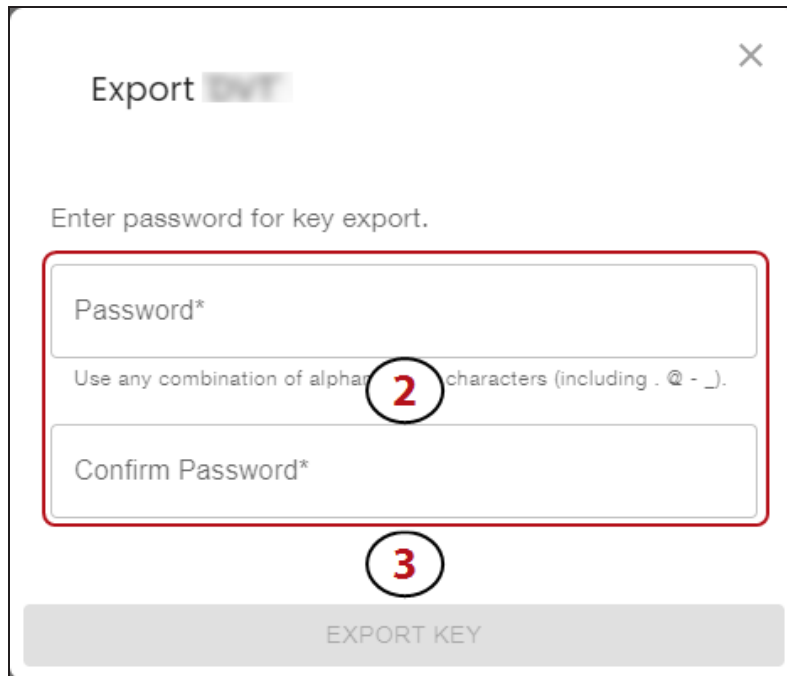

Figure 55 The Export screen.

2. Enter and confirm the **Password** for the selected key. The password is required when you import the key.
3. Click **Export Key**.

Deleting BlueScale Encryption Keys

Use the figures below to delete an existing BlueScale encryption key. Deleting an encryption key does not remove the encryption from any assigned partitions. Be sure to clear the encryption setting from existing partitions and to export a copy of the encryption key prior to deletion.



CAUTION

Make sure that you export a copy of the existing key before you delete it. You need a copy of the exported key and its password to import the key back into the library and restore data that was encrypted with the key.

1. Export at least one copy of the encryption key and store it in a safe location (see [Exporting BlueScale Encryption Keys](#) on the previous page).
2. If the encryption key you plan to delete is assigned to a partition, edit the partition to disable encryption (see [Modifying An Existing Partition](#) on page 99).



Figure 56 The Encryption screen.

3. From the Encryption screen, click **Delete** on the row of the key you want to delete.

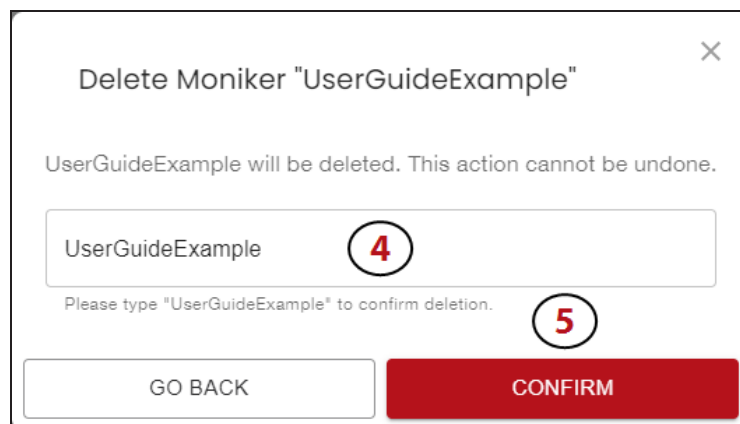

Figure 57 The Delete Moniker screen.

4. In the confirmation window, enter the **Moniker** of the key into the text field.
5. Click **Confirm** to delete the encryption key.

Authorization Settings

The section below provides an overview of the authorization settings in the LumOS user interface.



Figure 58 The Encryption screen.

1. Toggle the selector for **Enable Secure Initialization** if desired. Secure initialization requires encryption authorization on library initialization for drives in encrypted partitions before read and write actions can occur.

If you have a BlueScale Encryption Professional license with Multi User mode enabled, you must first enter two of the three configured Authorization Passwords before proceeding (see on page 105).

2. Click **Authorization Settings** button to open the Authorization Settings window.

Figure 59 The Authorization Settings screen.

3. In the **Current Password** text field, enter the current encryption password.
 4. Select the **User Mode** from the drop-down menu.
- Note:** Multi User mode requires a BlueScale Encryption Pro license.
5. Enter and confirm the **New Password** in the text fields. If Multi User mode is enabled, enter and confirm three unique passwords in the **New Password** text fields.
 6. Click **Submit**.

Note: To reset an expired password, you must use the LumOS API commands.

Multi User Mode

Multi User mode provides an additional layer of security and protection for your library. Multi User mode requires the user to create three unique passwords.

Multi User mode requires users enter two of the three unique passwords to authorize changing the Authorization Settings, importing an encryption key, exporting an encryption key, and toggling the Secure Initialization option selector. Multi User mode is a BlueScale Encryption Pro feature and requires a BlueScale Encryption Pro license.

Enabling Multi User Mode

To enable Multi User mode, first ensure your library has a BlueScale Encryption Pro license or add a BlueScale Encryption Pro license. See [Licenses on page 147](#). Navigate to the Encryption screen in the LumOS user interface, and click **Authorization Settings**.

Authorization Settings

User Mode

Multi User

New Password (User 1)

Use any combination of alphanumeric characters (including . @ - _). Leave the field blank to set an empty string as the password

Confirm New Password (User 1)

New Password (User 2)

Use any combination of alphanumeric characters (including . @ - _). Leave the field blank to set an empty string as the password

Confirm New Password (User 2)

New Password (User 3)

Use any combination of alphanumeric characters (including . @ - _). Leave the field blank to set an empty string as the password

Confirm New Password (User 3)

SUBMIT

Figure 60 The Authorization Settings screen.

1. Select **Multi User** from the drop-down menu.
2. Enter and confirm a passwords for User 1, User 2, and User 3.
Note: All three passwords must be unique.
3. Click **Submit**.

Using Multi User Mode

After enabling Multi User mode, the library requires users input two of the three configured passwords when taking the following actions: enabling or disabling Secure Initialization, modifying the Authorization Settings, exporting an encryption key, and importing an encryption key.

When performing one of these actions, enter any two of the configured passwords in the authorization password text fields then proceed as normal.

KMIP ENCRYPTION KEY MANAGEMENT OVERVIEW

The Key Management Interoperability Protocol (KMIP) is a centralized management system that allows you to manage the life cycle of the encryption keys and security certificates for your library. The LumOS user interface allows users to generate, store, and retrieve security keys used by tape drives for data encryption.

Before you configure your library to implement KMIP key management, install and configure KMIP on your server.

- Notes:**
- KMIP encryption key management is not compatible with BlueScale encryption key management because they cannot share encryption keys. Data encrypted using one type of encryption key management cannot be decrypted using a different type of encryption key management.
 - KMIP encryption is not compatible with PostScan. In the Partition Creation wizard, if PostScan is enabled, KMIP Encryption is not selectable on the Encryption screen.

Adding KMIP Encryption

Use the steps and figure below to configure KMIP encryption. To begin, log in to the LumOS user interface and select **Configuration > Encryption**.

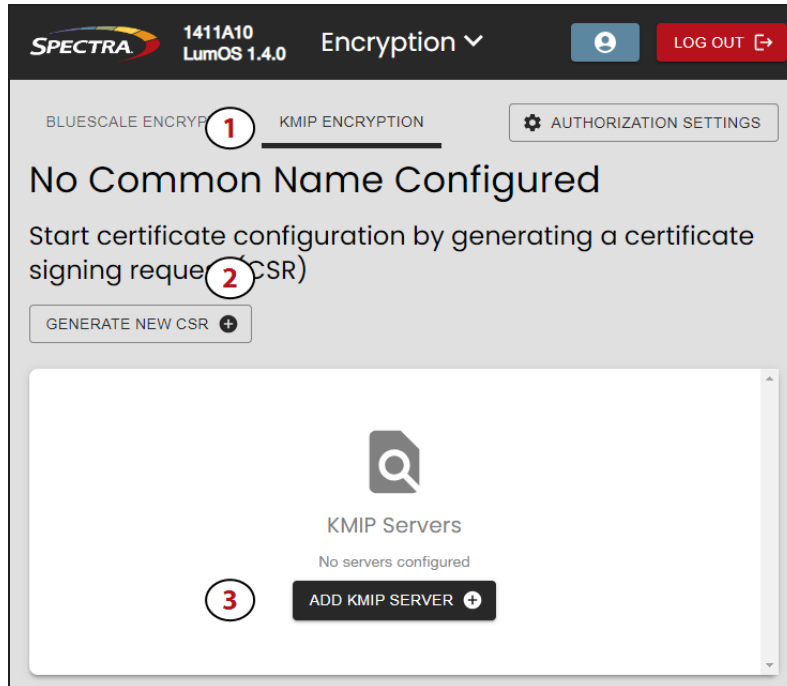

Figure 61 The KMIP Encryption screen.

1. Select **KMIP Encryption** at the top of the Encryption screen.

- Note:** The **KMIP Encryption** tab only displays if KMIP encryption is enabled for a partition on the library.
2. Click **Generate New CSR** to generate a certificate signing request. See [Generating Certificate Signing Requests](#) below for more details.
 3. Click **Add KMIP Server** to add a KMIP server. See [Adding KMIP Servers](#) on page 117 for more details.

Generating Certificate Signing Requests

Use the steps and figure below to generate a new certificate signing request.

The screenshot shows a dialog box titled "New Certificate Signing Request" with a close button in the top right corner. Under the heading "Certificate Characteristics", there are several text input fields. The "Common Name*" field contains the text "User Guide Example" and is marked with a red circle containing the number "1". Below it are fields for "Country", "State", "Locality", "Organization", and "Organizational Unit". The "Locality" field is marked with a red circle containing the number "2". A red rectangular box encloses the "Country", "State", "Locality", "Organization", and "Organizational Unit" fields. The "Organizational Unit" field is marked with a red circle containing the number "3". At the bottom of the dialog is a black button labeled "GENERATE CSR".

Figure 62 The New Certificate Signing Request screen.

1. In the **Common Name** text field, enter a common name.
2. Optionally, fill out the **Country**, **State**, **Locality**, **Organization**, and **Organization Unit** text fields.
3. Click **Generate CSR**.

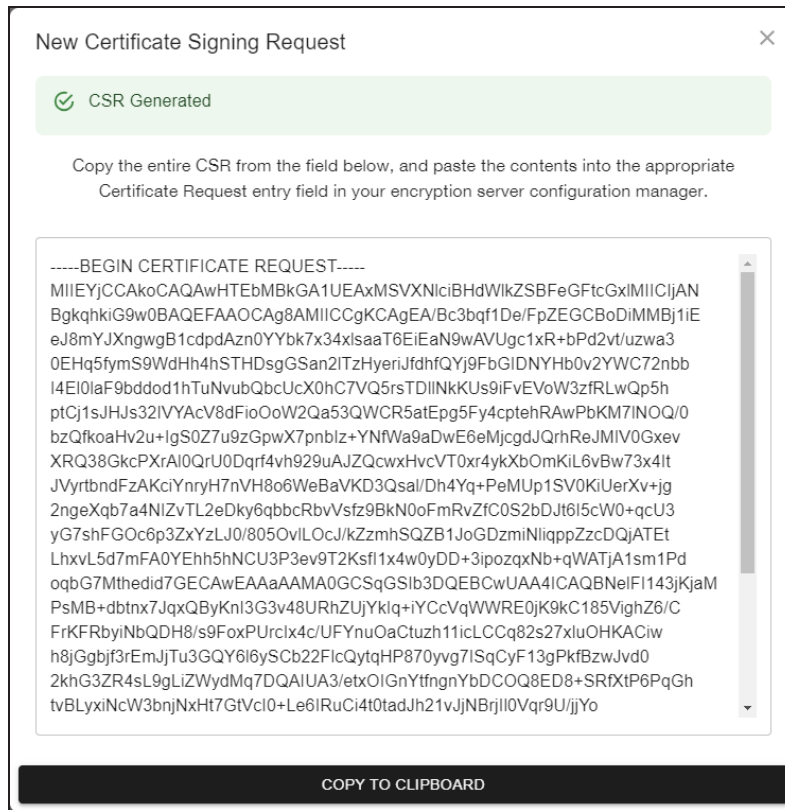

Figure 63 The New Certification Signing Request screen.

4. Click **Copy To Clipboard** to copy the new certification signing request.
5. Using your encryption server configuration manager, paste the copied certification signing request in the appropriate Certificate Request entry field.

Adding KMIP Servers

Use the steps and figure below to add a KMIP server.

1. In the **Hostname or IP Address** text field, enter the KMIP server hostname or IP address.
2. Optionally, enter the KMIP server port number in the **Port Number** text field.
3. Click **Save**.

Editing KMIP Servers

Use the steps below to edit a previously configured KMIP server. To begin, click **Edit Server** on the configured KMIP server you want to edit.

1. Edit the **Hostname or IP Address** and **Port Number** text fields.
2. Click **Save**.

Deleting KMIP Servers

Use the steps below to delete a previously configured KMIP server. To begin, click **Delete Server** on the configured KMIP server you want to delete.

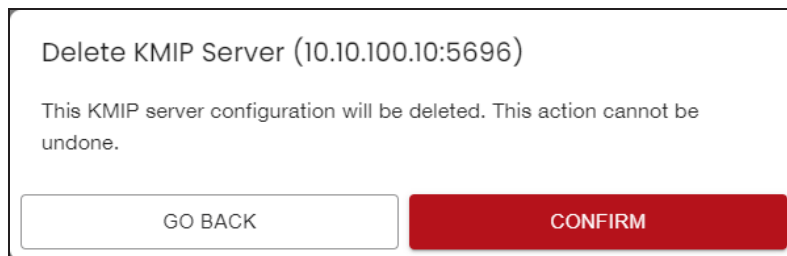

Figure 64 The Delete KMIP Server screen.

1. Click **Confirm** to delete the server.

CHAPTER 6 - USING THE LIBRARY

This chapter describes using the T950 library, including moving, importing, and exporting media.

| | |
|---|------------|
| Controlling the Library Power | 121 |
| Power On the Library | 121 |
| Power Off the Library | 122 |
| Importing, Exporting, and Exchanging Magazines | 123 |
| Dual TAP | 123 |
| Bulk TAP | 123 |
| Requirements | 123 |
| Restrictions | 124 |
| Performing an Import or Export | 126 |
| Importing Into a Storage or Cleaning Partition | 127 |
| Import Requirements | 127 |
| Prepare the Storage Partition or the Cleaning Partition | 129 |
| Import the Magazines | 130 |
| Exporting Magazines and Cartridges | 132 |
| Prepare for the Export | 132 |
| Export the Magazines or Cartridges in a Partition | 133 |
| Exchanging Magazines and Cartridges | 135 |
| Prepare for the Exchange | 135 |
| Exchange the Magazines or Cartridges in a Partition | 135 |
| Move Media | 137 |
| Moving Media | 137 |
| Media Lifecycle Management | 139 |
| Navigating the MLM Screen | 139 |
| Tape Details | 140 |
| Tape Mount History | 141 |
| Drive Lifecycle Management | 142 |
| Overview | 142 |
| Drive Health Reports | 142 |
| Drive Lifecycle Management | 143 |

| | |
|---------------------------------|------------|
| Navigating the DLM Screen | 143 |
| Drive Details | 144 |
| Drive Mount History | 145 |
| Drive Actions | 146 |
| Licenses | 147 |
| Adding a License | 147 |

CONTROLLING THE LIBRARY POWER

The library power is controlled using the front panel power button.

Power On the Library

Before powering on the library, make sure that all of the library's power cables are plugged into AC outlets and that the AC breaker switches corresponding to each cable, on the back of the main frame and each drive expansion frame, are set to the **on** (up) position.



IMPORTANT

For redundant AC power configurations, connect the primary and secondary input for each frame to a separate branch circuit, which allows for failover in the event of a power failure in one of the circuits (see for additional requirements).

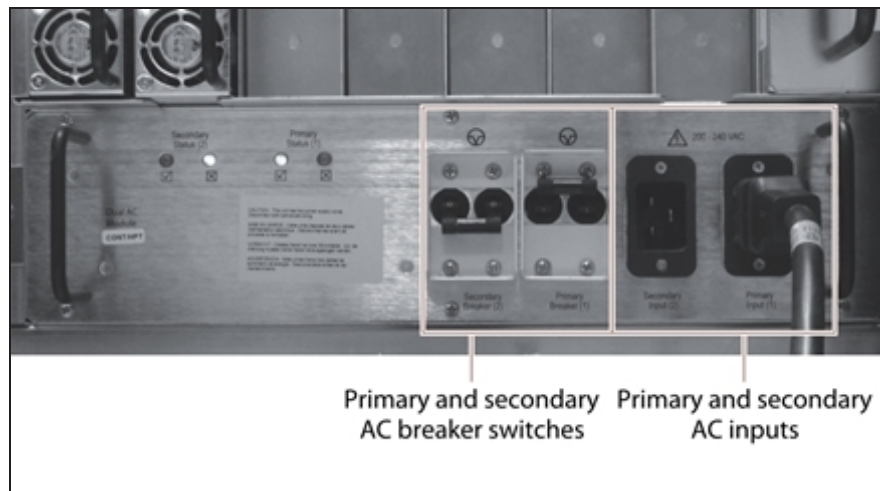

Figure 65 Connect the AC inputs and set the breaker switches to the **on** position.

Use the Front Panel Power Button

1. Press and hold the front panel power button until the button's LED illuminates and the LCD operator panel turns on.



Figure 66 The front panel power button.

2. Wait while the library completes its power-on sequence.
3. After initialization is complete, the LumOS login screen displays (see [Logging in to the LumOS User Interface](#) on page 50).

Note: If the library cannot complete the initialization process, it generates system messages and enters maintenance mode. Contact Spectra Logic Technical Support for assistance (see [Contacting Spectra Logic](#) on page 9).

Power Off the Library

Before powering off the library, use the following steps to prepare for shut-down.

1. Use your storage management software to stop any backups running to the library.
2. Move any media loaded in tape drives to storage locations.
3. Power off the library by pressing and holding the front panel power button for approximately 5 seconds (the button's LED starts flashing). The library begins its power-off sequence, which allows the LumOS software and components to shut down gracefully.



WARNING

The library is not de-energized when using the front panel or API commands to power off the library. To fully de-energize the library, you must disconnect the power cords from the back of the library.

Note: If you intend to leave the library powered down for an extended length of time, set the AC breaker switches on the back of the library (see [Figure 65](#) on page 121) to the **off** position after you power off the library.

IMPORTING, EXPORTING, AND EXCHANGING MAGAZINES

You can use the LumOS user interface to import, export, and exchange cartridges on the T950 library. You must be physically present at the library to perform these tasks, but the import and export process can be controlled remotely if desired. The T950 library supports multiple methods to import or export cartridges depending on library configuration and the number of magazines you need to move.

Dual TAP

For day-to-day operations involving a small number of magazines, you can import or export one at a time using the dual TAP located in the main frame. The two TAP doors open alternately.

Bulk TAP

When you need to import or export a large number of magazines, you can use a bulk TAP to process up to 14 magazines at a time.

Requirements

User Privilege Requirement

Any user with operator privileges who is assigned to the partition and all users with superuser or administrator privileges can perform import or export operations. See [Configuring Users on page 72](#) for information about assigning user to a partition.

Note: Operators assigned to the partition can only import and export to and from the Entry/Exit pool.

Cartridge and Magazine Labeling

Make sure that each cartridge and magazine is labeled with a unique barcode. The barcode labels on Spectra Certified Media contain information about the media type. To ensure that the correct type of cartridges are stored in a partition, the library prevents you from importing the wrong cartridge type into a partition.

TeraPack Magazines

Cartridges are always imported and exported using a TeraPack magazine (or a maintenance magazine for cleaning partitions), regardless of whether you have an individual cartridge or a group of cartridges.

- When you want to import a single cartridge, you must first put the prepared cartridge in a magazine, then import the magazine.
- When you want to export a single cartridge, you must export the magazine containing the cartridge and remove the desired cartridge from the magazine. You can then re-import the magazine if desired.

Restrictions

Using the LumOS Web Interface

Import, Export, and Exchange operations are normally performed using the operator panel on the front of the library; however, you can override this restriction and initiate the import, export, and exchange processes remotely using the LumOS user interface or API commands. See [Operator Panel Override](#) below for more information.

Background Operations

You cannot import, export, or exchange cartridges or magazines if the library is actively running a background operation such as Media Auto Discovery, PreScan, or PostScan.

Media Auto Discovery and PreScan are background operations that use the drives in a partition to discover newly imported cartridges and add them to the MLM database. The discovery process cannot begin while the hosts are actively loading cartridges into or unloading cartridges from the drives. If you import cartridges during this time, the library posts a failure message stating that no drives are available to perform the discovery process.

Operator Panel Override

You can override the operator panel restriction on Import, Export, and Exchange operations to initialize the operations using the LumOS web interface. To override the restriction using the LumOS web interface, navigate to **Operations** toolbar and select the desired operation screen and follow the steps below.

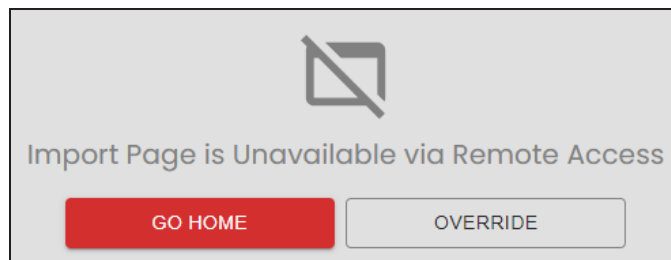

Figure 67 The Override button.

1. Click **Override**.



Figure 68 The Confirm Override screen.

2. Click **Confirm**.

Note: Overriding the operator panel only allows users to initialize operations and manipulate TAPs remotely. An operator must be physically present at the library to insert or remove magazines.

Performing an Import or Export

Importing and exporting requires you to manage the TeraPack Access Ports (TAPs) on the library. You can manage the TAPs using the buttons in the LumOS user interface. For an example, [Figure 69](#) shows **Main Top TAP Open Tap** and **Close Tap** buttons.

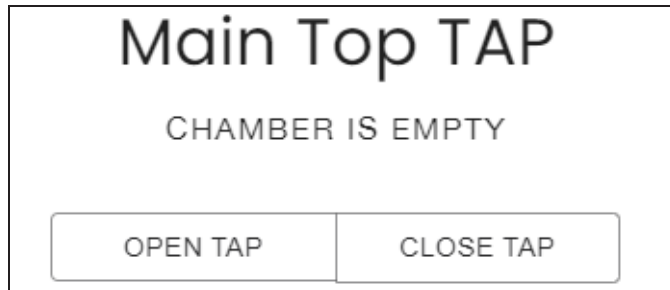

Figure 69 The LumOS Main TAP interface.

**CAUTION**

Only click the user interface buttons to manipulate the Center TAPs doors. Do not physically push or pull the doors/trays or damage may occur.

Use the links below to navigate to the corresponding sections:

- [Importing Into a Storage or Cleaning Partition on the next page](#)
- [Export the Magazines or Cartridges in a Partition on page 133](#)
- [Exchanging Magazines and Cartridges on page 135](#)

IMPORTING INTO A STORAGE OR CLEANING PARTITION

During normal operations, magazines containing data cartridges are typically imported to a storage partition's entry/exit pool and then moved to the storage pool using **Move Media** in the LumOS user interface. This process ensures that the media inventory maintained by the storage management software is accurate.

An exception is the first time that cartridges are loaded into a storage partition. Importing magazines directly into a storage partition's storage pool simplifies loading a storage partition for the first time. After the cartridges are imported into the storage pool, they are available for immediate use by the storage management software.

Import Requirements

Partitions

You must have one or more partitions defined before you can import magazines into the library. See [Partition Overview on page 85](#) for information about partitions and pools. [Creating A Partition on page 89](#) provides detailed instructions for creating partitions.

Cartridges and Magazines

All cartridges are imported into the library using magazines. Before beginning, have on hand the cartridges that you want to import into the partition.

If you are importing magazines into the storage partition's storage pool for the first time, the maximum number of magazines equals the number of chambers assigned to the storage pool for the partition. You do not need to fill all slots in the magazines or all of the chambers in the partition; however, any empty chambers are inaccessible to the storage management software.

Entry/Exit Pool

For daily operations, TeraPack magazines containing data cartridges are typically imported or exported using a storage partition's entry/exit pool. When using the entry/exit pool for importing/exporting, the following must be true:

- The entry/exit pool must have sufficient empty chambers available for importing new magazines. If you need to import new magazines and all of the chambers in the entry/exit pool are full, you must export one or more magazines to make space for the new magazines.

- The entry/exit pool must have sufficient empty slots available to accommodate any cartridges that the storage management software ejects from the partition. If all of the slots in the entry/exit pool are full, either move newly imported cartridges to the partition's storage pool, leaving empty slots in the entry/exit pool, or export one or more full magazines and replace them with magazines that have empty slots.

**IMPORTANT**

Make sure that the magazines you export are not filled with cartridges that you just imported but did not yet move to the storage pool using the LumOS user interface.

- You can import a magazine containing a cleaning cartridge into the partition's entry/exit pool and then use the Inventory screen to move the cartridge to a drive for cleaning. When the cleaning is complete, move the cleaning cartridge back to the entry/exit pool and export the magazine from the entry/exit pool.

Storage Pool

A storage partition's storage pool contains all of the cartridges that can be accessed by the storage management software for the purpose of writing or reading data.

- If you are importing magazines into the entry/exit pool and using your storage management software to move the cartridges to the storage pool, the storage pool must have sufficient empty slots to accommodate each cartridge imported into the entry/exit pool.
- If you are importing directly into the storage pool, the storage pool must have sufficient empty chambers to accommodate the magazines you plan to import.
- Any chambers in the storage pool that do not contain magazines are inaccessible to the storage management software. You can, however, import magazines into the empty chambers using the library's LumOS user interface.

Cleaning Partition

When importing cleaning cartridges into a cleaning partition, keep the following in mind:

- Cleaning cartridges must be identified with "CLN" at the beginning of the barcode sequence on their labels. This requirement applies to both standard and custom barcode labels.
- Cleaning cartridges used in a cleaning partition must be in Maintenance TeraPack magazines, which are identified by Spectra-unique labels. The library automatically prevents importing cleaning cartridges and magazines that are not properly labeled into a cleaning partition.

Note: Maintenance TeraPack magazines filled with appropriately labeled cleaning cartridges are available from Spectra Logic.

- Make sure that the Maintenance TeraPack magazine does not contain any data cartridges. The library will not import a Maintenance TeraPack magazine that contains cartridges that are not identified with “CLN” at the beginning of the barcode sequence on their labels.
- Make sure that you import only cleaning cartridges that are compatible with the drives in the storage partition associated with the cleaning partition. To ensure that the correct type of cleaning cartridges are stored in a cleaning partition, the library prevents you from importing the wrong cartridge type.
- The cleaning cartridges in a cleaning partition can only be used for drives in storage partitions configured to use that cleaning partition. Associating a cleaning partition with drives in a storage partition automatically enables the Auto Drive Clean feature for that partition.
- The cleaning cartridges in the cleaning partition are inaccessible to the application software running on the host. Make sure you disable any software-based drive cleaning to prevent repeated requests to import a cleaning cartridge.
- If your storage management software supports automated drive cleaning and you plan to use this method to clean the drives instead of the library’s Auto Drive Clean feature, refer to your software documentation for instructions. You must import the properly labeled cleaning cartridges into the storage partition using a TeraPack magazine (not a Maintenance TeraPack magazine).

Prepare the Storage Partition or the Cleaning Partition

Before importing magazines into a storage partition or a cleaning partition, make sure that the partition has sufficient empty slots or chambers available to accommodate the cartridges or magazines you plan to import.

- If you plan to import cartridges into the storage partition’s entry/exit pool, and then use your storage management software to move the cartridges to the storage pool, check the Inventory screen for the partition to make sure that the storage pool has an empty slot available to accommodate each imported cartridge. If there are insufficient empty slots available in the storage pool, do one of the following to prepare the storage pool to receive the imported cartridges:
 - If the partition’s storage pool has empty chambers, import one or more TeraPack magazines with empty slots into the storage pool.
 - If the partition’s storage pool does not have any magazines with empty slots, use your storage management software to eject cartridges from the library. The library moves the ejected cartridges from the partition’s storage pool to magazines in its entry/exit pool. You can then export the magazines from the library. The resulting empty slots in the storage pool are now available for newly imported cartridges.
 - Exchange a full magazine in the storage pool for one containing empty slots.

- If you plan to import cartridges directly into the partition's storage pool, make sure that the storage pool has an empty chamber for each magazine you plan to import. The partition's Import/Export screen shows the number of empty chambers available in the partition's storage pool. If there are no empty chambers available in the storage pool, export one or more magazines from the storage pool.
- If you plan to import cleaning cartridges into a cleaning partition, make sure that there is an empty chamber for each maintenance magazine you plan to import. If there are no empty chambers available in the cleaning partition, export one or more magazines. Alternatively, you can exchange expired cleaning cartridges for new ones in the magazines already present in the cleaning partition without having to import additional magazines.

Import the Magazines

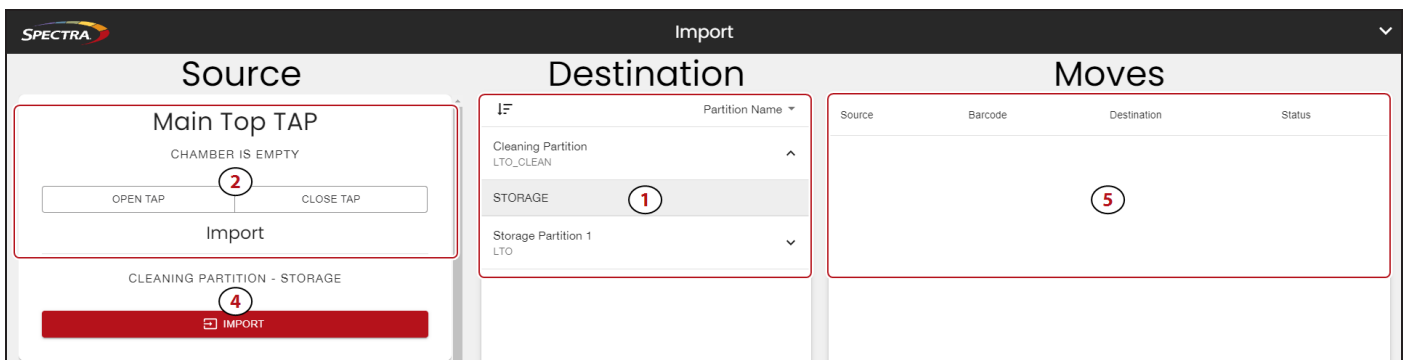

Figure 70 The LumOS Import screen.

To import a magazine, log into the library as a user with the appropriate privileges and select **Operations > Import Media** in the LumOS user interface. Use [Figure 70 on page 130](#) above to help you import media:

1. Select the desired **Destination** partition and pool type from the list.
 - Note:** Cleaning partitions can only select the **Storage** pool. Storage partitions can select either the **Storage** or **Entry/Exit** pools.
2. Click **Open TAP**.
3. Insert the magazine into the tray on the open TAP with the textured surface side toward the outside of the library, as shown in [Figure 71 on page 131](#).

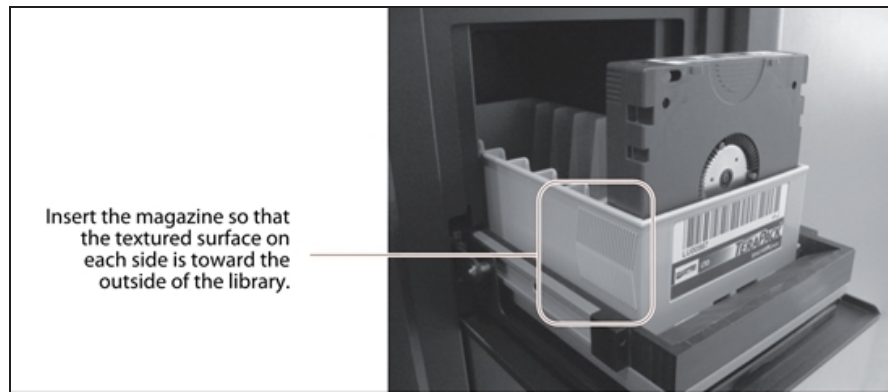

Figure 71 Insert a magazine into the TAP, making sure that it is correctly oriented.

4. Click **Close TAP** to close the TAP door.
5. Click **Import** to start the import.
6. Review the **Moves** column for your import history.
7. To import additional magazines, repeat the above steps. Alternatively, use the **Bulk TAPs** in the **Source** column to import up to 14 magazines at once.

Note: Bulk TAP doors cannot be opened or closed using the LumOS user interface and must be operated manually.

- a. Open a bulk TAP door by clicking **Open TAP** to unlock the door then manually open the door by pressing the button next to the door. The button flashes when the door is unlocked. While the bulk TAP is open, the bulk TAP dialogue displays.
- b. Close the bulk TAP door by pressing firmly at the top and bottom until you hear an audible click, then click **Close TAP**.
- c. Ensure your magazines are seated, your import pool is selected, and the bulk TAP door is closed, then click **Import**.

EXPORTING MAGAZINES AND CARTRIDGES

The export process uses either the dual TAP or bulk TAP to physically remove all of the magazines (and any cartridges they contain) from the selected location (a cleaning partition or storage partition's entry/exit pool or storage pool). The exported magazines are not replaced by new magazines.

Prepare for the Export

- If you want to export cartridges from a storage partition, use the your storage management software to eject the desired cartridges from the partition's storage pool. You can then export the cartridges from the entry/exit pool. Using this method to export cartridges from a storage partition ensures that the media inventory maintained by the storage management software remains accurate.

The following steps describe the process for ejecting cartridges from a storage partition using the entry/exit pool.

1. Use your storage management software to eject the cartridges from the library.
2. The library moves each cartridge out of the partition's storage pool and into an empty slot in a TeraPack magazine already stored in the entry/exit pool.
3. When all of the requested cartridges are in the entry/exit pool, the library reports to the software that the export request is complete.
4. At your convenience, you can then export the magazines in the entry/exit pool from the library using controls on the Export screen of the user interface and either the dual TAP, or bulk TAP.

**IMPORTANT**

When exporting tape cartridges from a partition with SlotIQ enabled, Spectra Logic recommends that you use your host software to move the cartridges to the Entry/Exit pool before exporting.

- Exporting a magazine directly from the storage pool is not recommended unless you are exporting all of the magazines from a partition. This process is often referred to as a "bulk export."

If you choose to export magazines directly from the storage partition's storage pool, be sure to use your storage management software to update its media inventory after completing the export.

Export the Magazines or Cartridges in a Partition

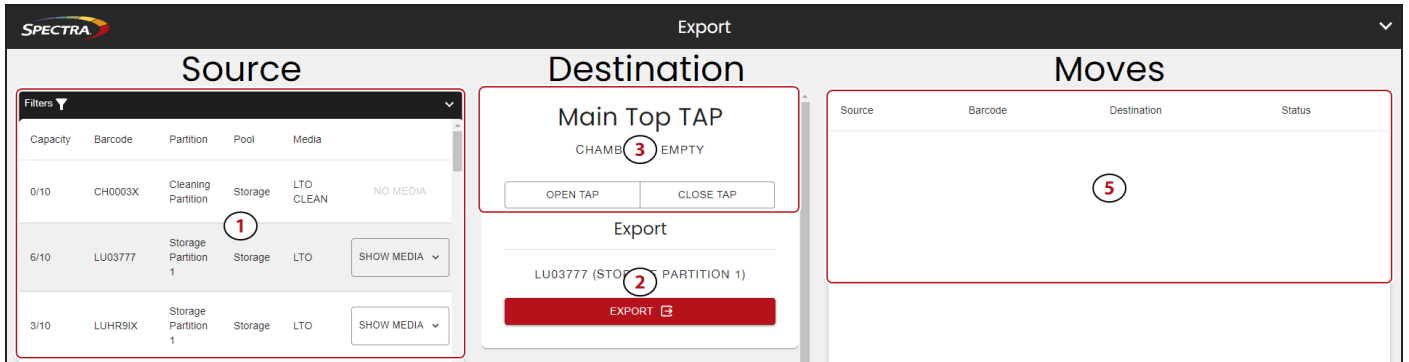

Figure 72 The LumOS Export screen.

To export a magazine or cartridge, log into the library with the appropriate privileges and select **Operations > Export Media** in the LumOS user interface. Use above to help you export media:

1. Select the desired **Magazine** in the **Source** column.
2. Click **Export**.
3. Click **Open TAP** to access the exported magazine. Remove the magazine or desired cartridges from the magazine.
4. Click **Close TAP** to close the TAP door.
5. Review the **Moves** column for your export history.
6. To export additional magazines, repeat the above steps. Alternatively, use the **Bulk TAPs** in the **Destination** column to export up to 14 magazines at once.

Note: Bulk TAP doors cannot be opened or closed using the LumOS user interface and must be operated manually.

- a. Select the desired **Destination** bulk TAP and click **Export**.
- b. Open the bulk TAP door by clicking **Open TAP** to unlock the door then manually open the door by pressing the button next to the door. The button flashes when the door is unlocked.

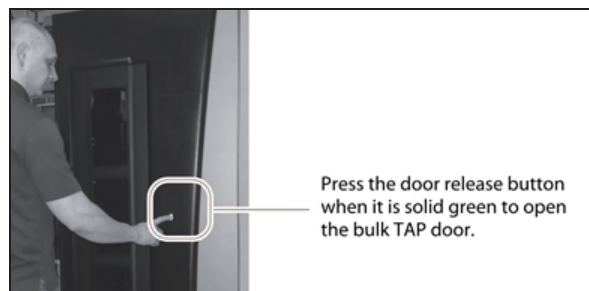

Figure 73 Press the door release button to open the door.

- c. Access the exported magazines inside the bulk TAP. While the bulk TAP is open, the bulk TAP dialogue displays.

- d. Close the bulk TAP door by pressing firmly at the top and bottom until you hear an audible click, then press **Close TAP**.

EXCHANGING MAGAZINES AND CARTRIDGES

The exchange process moves each of the magazines in the selected location to either the dual TAP or the bulk TAP so that you can exchange the magazines for others of the same type.

You can also remove or exchange one or more individual cartridge(s) in a magazine while leaving the other cartridges in place. Exchanging cartridges in a magazine is especially useful when you need to temporarily import a cleaning cartridge into the storage pool as part of drive maintenance.

Prepare for the Exchange

Be sure to have the prepared cartridges and labeled magazines on hand before beginning the exchange.

Exchange the Magazines or Cartridges in a Partition

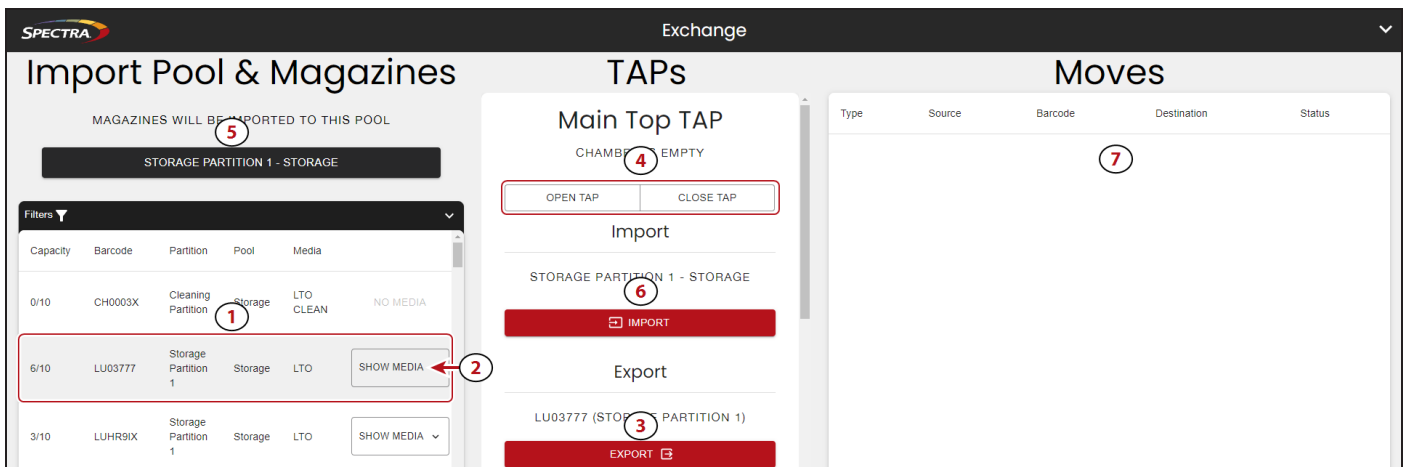

Figure 74 The LumOS Exchange screen.

To exchange a magazine or cartridge, log into the library with the appropriate privileges and select **Operations > Exchange Media**. Use above to help you exchange media.

1. Select a magazine to export from the magazine list.
2. If desired, click **Show Media** to display the cartridge ID and barcodes contained in the magazine.
3. Click **Export** on the desired TAP to export the selected magazine to that TAP. If you are using the dual TAPs, continue with Step 4 on page 135. If you are using the bulk TAPs, continue with Step 8 on page 136.
4. Click **Open TAP** to access the exported magazine. Exchange the magazine or any desired media in the TAP then click **Close TAP**. If you exchange a magazine, make sure the new magazine is oriented correctly (see Figure 71 on page 131).

5. Click **Select A Pool** to select the pool to which you want to exchange media.
6. Click **Import** to import the new media to the selected pool.
7. Review the **Moves** column for your import and export history.
8. Use the **Bulk TAPs** to exchange up to 14 magazines at once.
 - a. Open the bulk TAP door by clicking **Open TAP** to unlock the door then manually open the door by pressing the button next to the door. The button flashes when the door is unlocked.

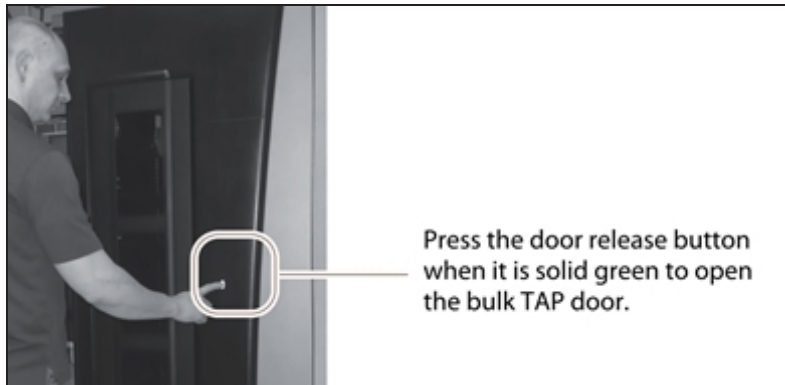

Figure 75 Press the door release button to open the door.

- b. Access and exchange the exported magazines inside the bulk TAP. While the bulk TAP is open, the bulk TAP dialogue displays.
- c. Close the bulk TAP door by pressing firmly at the top and bottom until you hear an audible click, then press **Close TAP**.
- d. Click **Import** on the bulk TAP to import the new media to the selected import pool.

MOVE MEDIA

Overview

During normal operations, you typically use your storage management software to move cartridges from one location to another within the library. However, you may occasionally need to create and process a move queue to direct the library to move cartridges manually. This can be done using the library's LumOS user interface or REST API to locate and move individual cartridges (for example, to move a cleaning cartridge stored in the storage partition to a drive if you are not using the Auto Drive Clean option). Use the instructions below to manually direct cartridge moves using the LumOS user interface.

User Privilege Requirements

The user privilege requirements when moving cartridges in a storage partition depend on how the library is being accessed. Operator users can only move cartridges within their assigned partitions. Superuser or administrator users can move cartridges within any partition.

Moving Media

To move media in the library, log in and select **Operations > Move Media**, then **Select** the partition for which you want to move media. The user interface refreshes to display the inventory of the selected partition.

The screenshot shows the LumOS Inventory screen for the 'User Guide Partition (LTO)'. It is divided into three main sections: 'Source', 'Destination', and 'Moves'.

Source: A table with columns 'Type', 'Address', and 'Barcode'. A red line highlights the 'Slot/Drive Range' from 4098 to 4155. The table contains the following data:

| Type | Address | Barcode |
|------|---------|----------|
| SLOT | 4098 | 418070L5 |
| SLOT | 4100 | 452653L5 |
| SLOT | 4103 | 1AN316L5 |
| SLOT | 4104 | 367581L6 |
| SLOT | 4107 | 502967L5 |
| SLOT | 4108 | 032192L6 |
| SLOT | 4109 | 021545L6 |
| SLOT | 4110 | 415108L5 |

Destination: A table with columns 'Type' and 'Address'. The table contains the following data:

| Type | Address |
|------|---------|
| SLOT | 4099 |
| SLOT | 4101 |
| SLOT | 4102 |
| SLOT | 4105 |
| SLOT | 4106 |
| SLOT | 4118 |
| SLOT | 4119 |
| SLOT | 4120 |
| SLOT | 4121 |
| SLOT | 4122 |
| SLOT | 4123 |

Moves: A section with a 'MOVE QUEUE' table and an 'ISSUED MOVES' table. The 'MOVE QUEUE' table has columns 'Source', 'Barcode', and 'Destination'. It contains one entry:

| Source | Barcode | Destination |
|--------|----------|-------------|
| 4096 | 453863L5 | 4097 |

At the bottom of the 'Moves' section, there are buttons for 'DISCARD QUEUE' and 'SUBMIT QUEUE'.

Figure 76 The LumOS Inventory screen.

Use Figure 76 to help you move media:

1. Select the desired **Source** slot from the list.
2. Select the desired **Destination** slot from the list.

Note: You can filter **Source** and **Destination** by **Slot, Drive, or Entry/Exit** port. Additionally you can directly **Search** or limit the displayed range.

3. Verify the information displayed in the **Moves** column matches the desired **Source, Barcode, and Destination**. Click **Add To Move Queue** if the information is correct. Repeat as necessary to add additional moves to the **Move Queue**.
4. Confirm that the **Move Queue** lists all desired moves. Click the minus icon to remove a specific move from the queue, if necessary.

Note: Clicking the **Issued Moves** tab displays the partition move history.

5. Click **Submit Queue** to issue the move commands.

MEDIA LIFECYCLE MANAGEMENT

This section describes how to use Media Lifecycle Management to proactively monitor and report on the health of cartridges in your library. To view T950 library Media Lifecycle Management (MLM) information, log in and navigate to **Status > MLM**.

| Tape Barcode | Health | Current Partition | Load Count | Soft Write Errors | Certification Date | Remaining Capacity (MB) | Maximum Capacity (MB) | Last Read Time (America/Denver) | Last Write Time (America/Denver) |
|--------------|--------|-------------------|-------------|-------------------|--------------------|-------------------------|-----------------------|---------------------------------|----------------------------------|
| 040117L5 | ✓ | AllSixteen | 736 | 0 | 2015-05-16 | 1445862 (100%) | 1449584 | Jan 23, 2025 3:11 AM | Jan 23, 2025 3:11 AM |
| 415164L5 | ✓ | AllSixteen | Uncertified | 0 | Uncertified | 1448585 (100%) | 1449584 | Uncertified | Uncertified |
| 415166L5 | ✓ | AllSixteen | Uncertified | 0 | Uncertified | 1449584 (100%) | 1449584 | Uncertified | Uncertified |
| 415215L5 | ⚠ | AllSixteen | Uncertified | 0 | Uncertified | 1413338 (100%) | 1413345 | Uncertified | Uncertified |

Figure 77 The LumOS MLM screen.

Navigating the MLM Screen

Use [Figure 77](#) to help you navigate the features of the MLM screen.

1. Use the drop-down menu to select between viewing **Present Media** or **Exported Media**.
2. Use the **Search** feature to filter the records by partial or complete tape barcode.
3. Use the **Tape Health** drop-down to filter the records by the selected tape health status.
4. Use the **Partition** drop-down menu to filter the records by partition.
5. Toggle the **Show Unassigned** slider to display records for tape cartridges not currently assigned to a partition.
6. Click the **Tape Barcode** buttons to view detailed tape information. See [Tape Details](#) on the next page.

Tape Details

Click a **Tape Barcode** button pictured in Figure 77 to view the tape details screen.

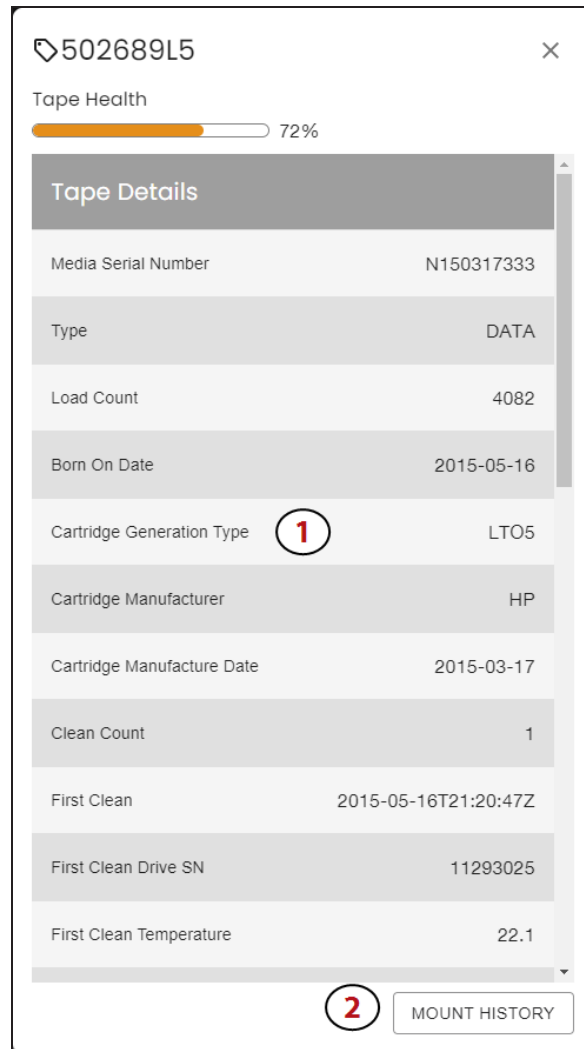

Figure 78 The LumOS Tape Details screen.

1. The **Tape Details** screen displays all tracked metrics for the tape.
2. Click **Mount History** to display the Mount History screen for the selected tape. See [Tape Mount History](#) on the next page.

Tape Mount History

Use Figure 79 to help you navigate the mount history screen.

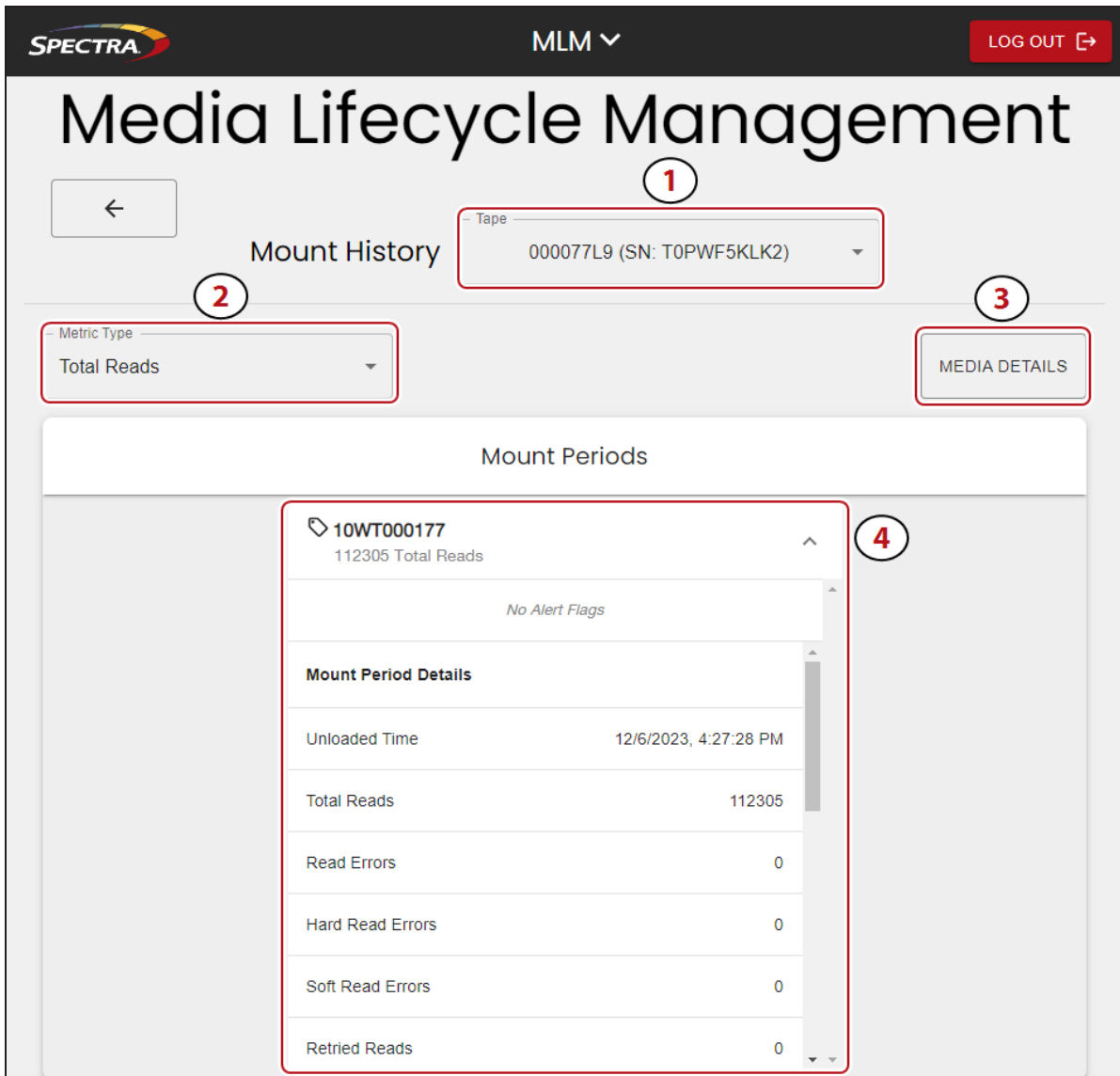

Figure 79 The LumOS Mount History screen.

1. Use the **Tape** drop-down menu to select the tape for which you want to view mount history information.
2. Use the **Metric Type** drop-down menu to select the metric you want to view on all mount periods.
3. Click **Media Details** to view the media details for the tape. See [Tape Details](#) on the [previous page](#) for more information.
4. Click on a mount history entry to expand and view all mount period details.

DRIVE LIFECYCLE MANAGEMENT

Overview

Drive Lifecycle Management works in conjunction with Media Lifecycle Management to help you identify drives that experience a high number of errors or other problems during operation.

Each time a cartridge is unloaded from a drive, the library collects media health data from the drive. This data includes read/write errors, tape alerts, and flags generated during the time the most recent cartridge was loaded in the drive. It also includes the current value for the drive's single character display (SCD) and any errors detected at the time the cartridge is unloaded. All of this data, plus the MLM data for the 50 most recently loaded cartridges, is stored in the DLM database. This data is used to generate an overall drive health status for the library, as well as health reports for each individual drive.

Drive Health Reports

A health icon next to each drive indicates the overall health of the drive. Detailed reports provide information about the cartridges that have been loaded into the drive and any errors reported. The DLM database containing the health information for every drive in the library is backed up whenever the library is backed up.

DRIVE LIFECYCLE MANAGEMENT

The LumOS user interface allows you to monitor the drives in the T950 library. To view the Drive Lifecycle Management (DLM) screen, log in and navigate to **Status > DLM**.

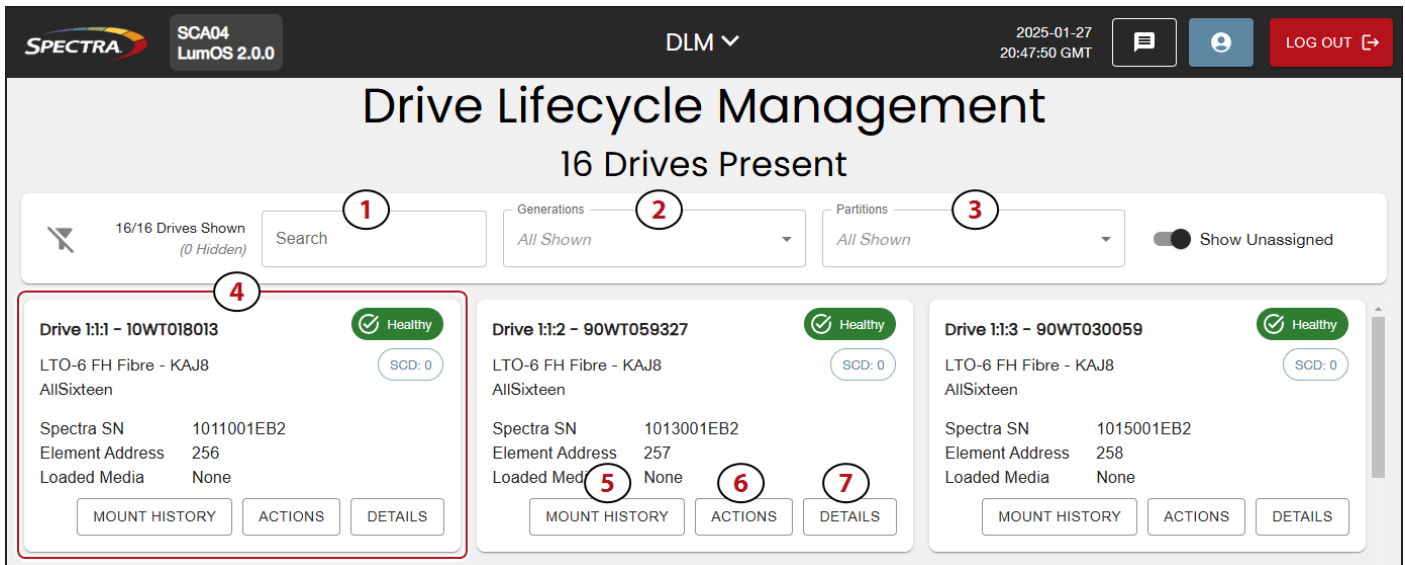

Figure 80 The LumOS DLM screen.

Navigating the DLM Screen

Use [Figure 80](#) to help you navigate the features of the DLM screen.

1. Use the **Search** entry field to search for drives by serial number.
2. Use the **Generations** drop-down menu to filter the records by drive generation.
3. Use the **Partitions** drop-down menu to filter the records by the partition to which the drive is assigned.
4. Each drive pane displays basic information about the drive.
5. Click **Mount History** to display the mount history for the drive. See [Drive Mount History on page 145](#) for more information.
6. Click **Actions** to display the action history to access the Drive Actions menu, which allows you to clean, reset, or replace a drive. See [Drive Actions on page 146](#) for more information.
7. Click **Details** to display the drive details screen. See [Drive Details on the next page](#) for more information.

Drive Details

Use Figure 81 on page 144 to help you navigate the Drive Details screen.

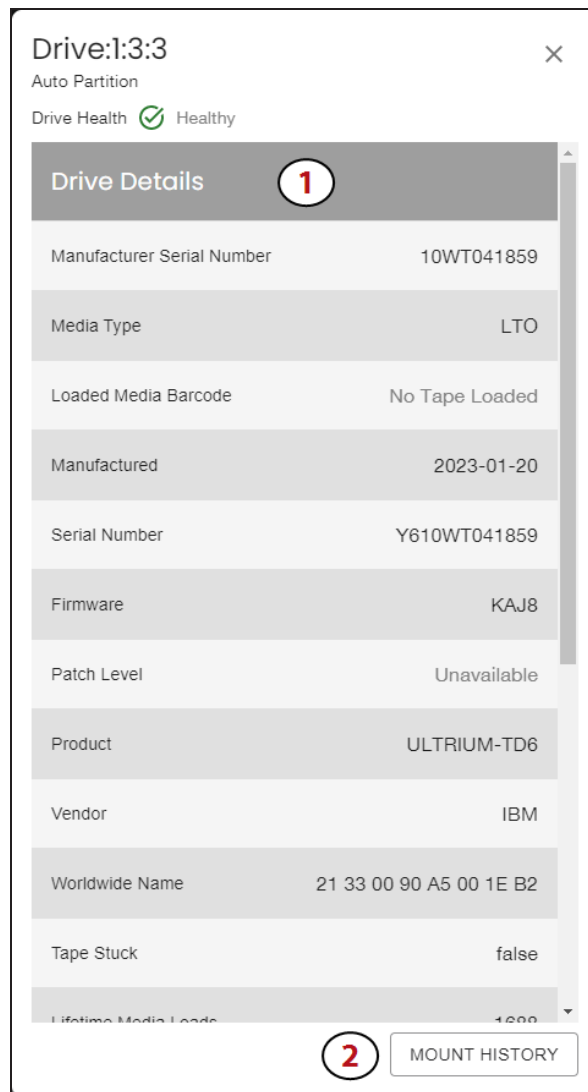

Figure 81 The LumOS Drive Details screen.

1. The Drive Details screen lists the metrics for the drive.
2. Click **Mount History** to display the Drive Mount History screen. See [Drive Mount History](#) on the next page for more information.

Drive Mount History

Use Figure 82 to help you navigate the Drive Mount History screen.

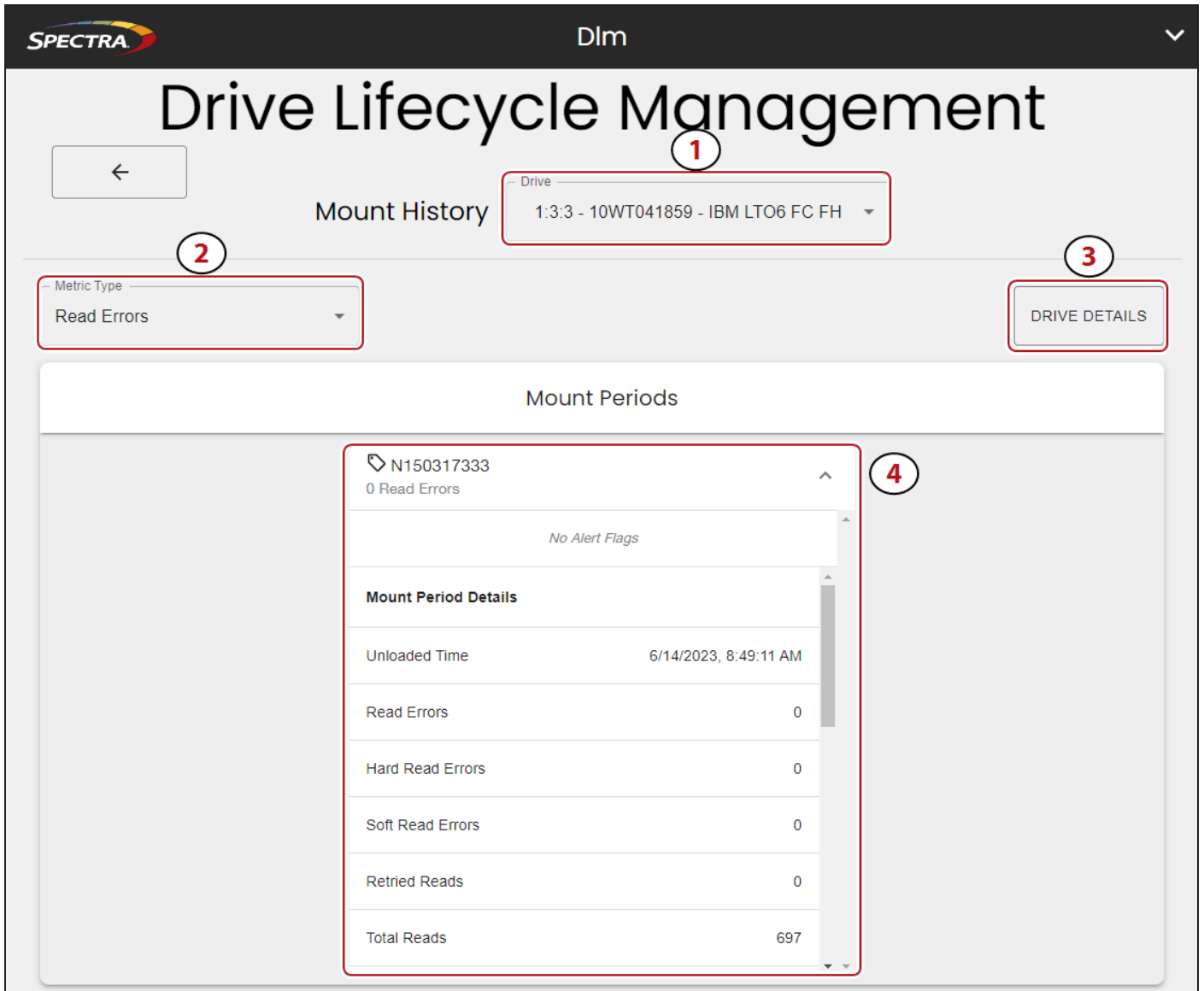

Figure 82 The LumOS Mount History screen.

1. Use the **Drive** drop-down menu to select the drive for which you want to view details.
2. Use the **Metric Type** drop-down menu to select the metric you want to view on all mount periods.
3. Click **Drive Details** to display drive details for the drive. See [Drive Details on the previous page](#) for more information.
4. Click on a mount history entry to expand and view all mount period details.

Drive Actions

Use the figure below to help you navigate the **Drive Actions** screen.

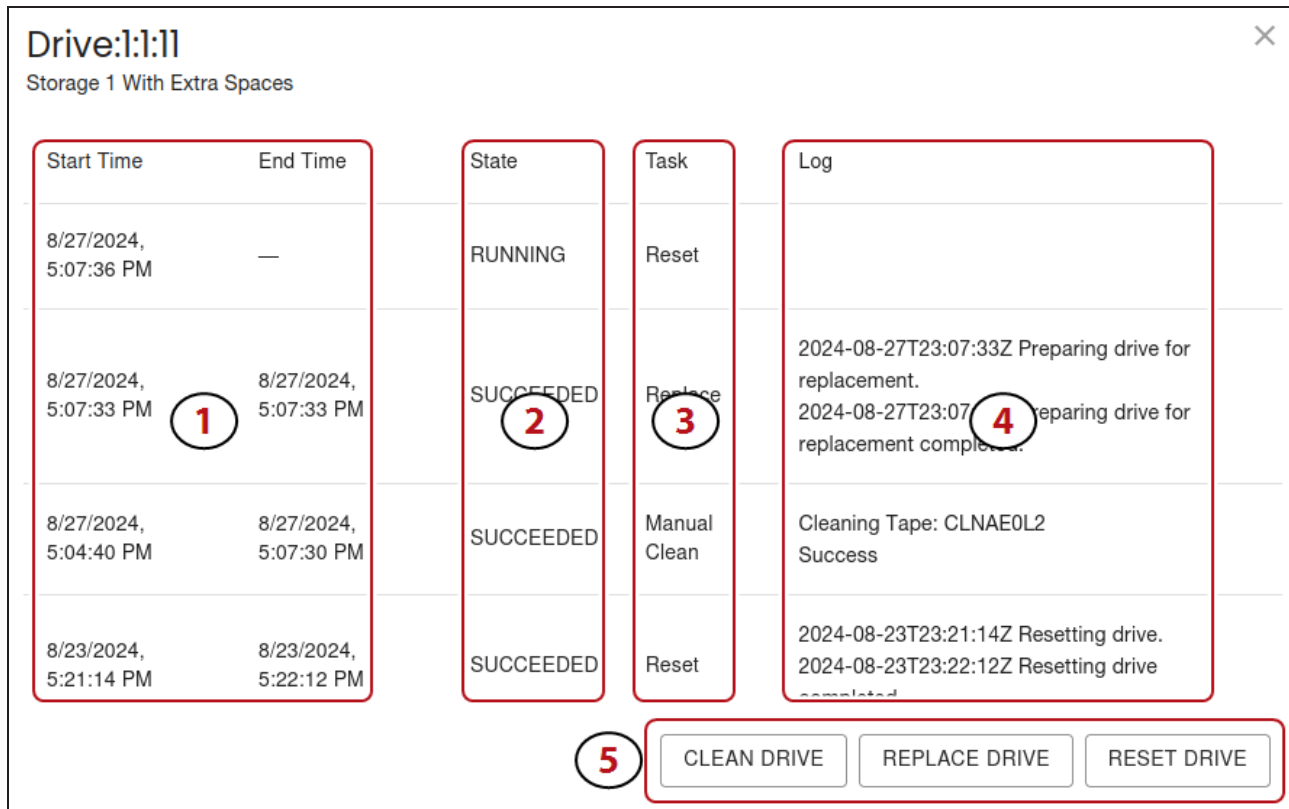

Figure 83 The LumOS Drive Actions screen.

1. **Start Time** and **End Time** display the start and end date and time an action.
2. **State** displays the current status of an action.
3. **Task** displays the type of action.
4. **Log** displays a detailed description of the action.
5. The action buttons initiate the corresponding action on the drive:

Clean Drive - Initialize a manual clean of the drive. The drive must be configured in a partition associated with a cleaning partition, and valid cleaning media must be present in the associated cleaning partition.

Replace Drive - Shuts down the drive to prepare for replacement. Contact Spectra Logic Technical Support for assistance replacing a drive.

Reset Drive - Resets the drive. If possible, empty the drive before performing the reset.

LICENSES

The LumOS user interface allows you to add and monitor licenses. To add a new license to the T950 library, log in and navigate to **Configuration > Licensing**.

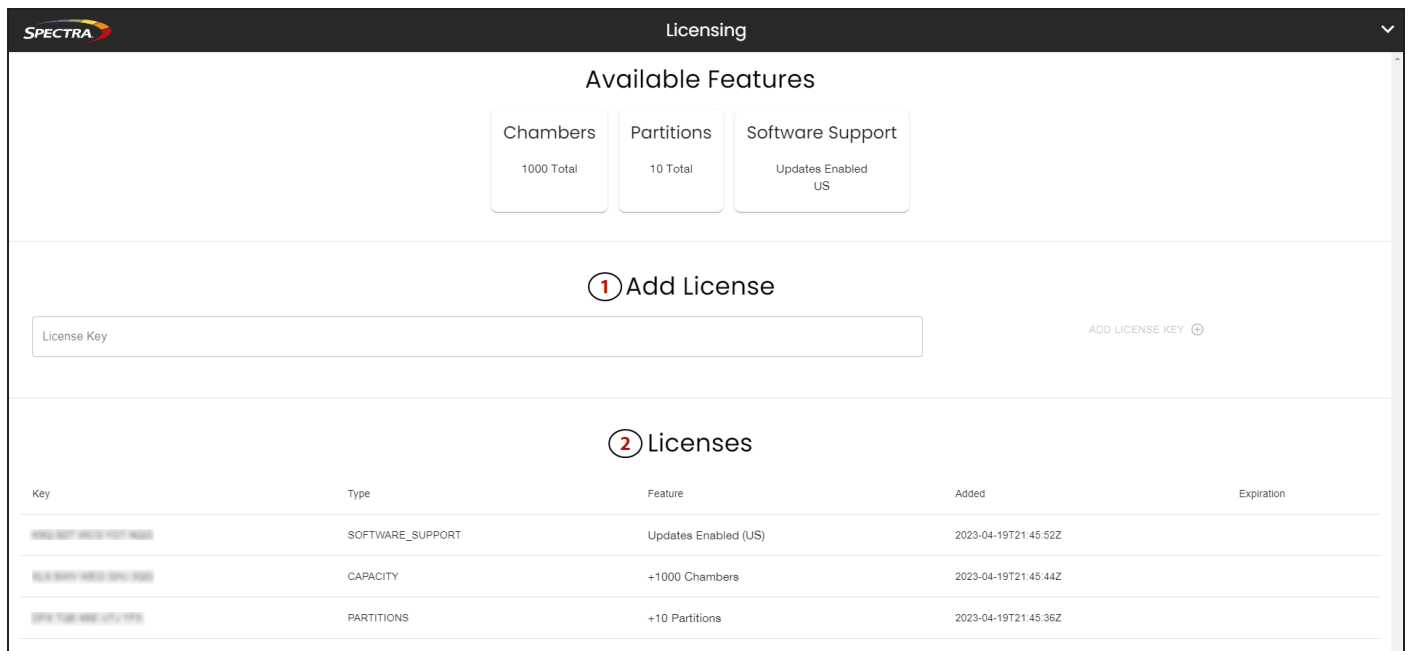

Figure 84 The LumOS Licensing screen.

Adding a License

To add a license:

1. Enter the **License Key** in the entry field and click **Add License Key**.
2. Confirm the new license displays in the **Licenses** pane.

CHAPTER 7 - MAINTAINING THE LIBRARY

This chapter describes maintaining the T950 library, including updating library software, managing library backups, running diagnostics, and generating log files for use in troubleshooting.

| | |
|---|------------|
| Updating, Servicing, or Moving the Library | 149 |
| Diagnostics & Utilities | 150 |
| Alerts | 176 |
| Configuring Alerts | 178 |
| Adding or Editing Alert Subscribers | 179 |
| Log Gathering | 181 |
| Gathering Logs | 181 |
| Managing Backups | 182 |
| Package Update | 184 |
| Overview | 184 |
| Configuring a Package Update | 184 |
| Drive Firmware Update | 186 |
| Updating Drive Firmware in LumOS User Interface | 186 |
| Updating Drive Firmware Using ITDT | 192 |
| Robotics | 195 |
| Robot Details | 195 |

UPDATING, SERVICING, OR MOVING THE LIBRARY

Contact Spectra Logic Technical Support before making any changes to your library hardware or performing any service operations.

Servicing the Library

In the event that it is necessary to replace a component, make sure that you have instructions for performing the procedure *and* you either:

Are instructed to do so by Spectra Logic Technical Support,

—OR—

Have a support contract such as Assisted Self-Maintenance (ASM).

Moving the Library

The library hardware is configured to ensure proper thermal control, air flow, and dust filtering. After the library is installed, do not move the library.



IMPORTANT

Moving the library without assistance from a Spectra Certified Field Engineer voids your service contract. Contact Spectra Logic Technical Support for assistance if you need to relocate your library (see [Contacting Spectra Logic on page 9](#)).

DIAGNOSTICS & UTILITIES

The LumOS user interface allows you to run library diagnostics remotely. To run a diagnostic, log in and navigate to **Tools > Diagnostics & Utilities**. You can run the following diagnostic tests:

- **All Basic Motion Diagnostics on page 152**
- **Barcode Reader Test on page 153**
- **Bulk TAP Test on page 154**
- **Delete All Partitions on page 154**
- **Delete Geometry on page 155**
- **Exercise TAP Diagnostic on page 156**
- **HAX Binding Diagnostic on page 156**
- **HAX Sensor Diagnostic on page 157**
- **MAX Sensor Diagnostic on page 158**
- **Move to Chambers on page 158**
- **Move to Drives on page 159**
- **Move to Shelf on page 161**
- **Obstruction Scan on page 161**
- **PAX Sensor Diagnostic on page 162**
- **Power Cycle Library on page 163**
- **RAX Sensor Diagnostic on page 163**
- **Reset Geometry on page 164**
- **Reset Inventory on page 165**
- **Robotics Positioning Test on page 166**
- **SAX Sensor Diagnostic on page 168**
- **Shelf Sensor Test on page 168**
- **Snout Sensor Test on page 169**
- **Security Audit on page 170**
- **TAX 50/50 Sensor Diagnostic on page 171**
- **TAX TeraPack Sensor Diagnostic on page 171**
- **Unload Drives on page 172**
- **VAX Column Alignment Diagnostic on page 173**
- **VAX Sensor Diagnostic on page 174**

- **Verify Magazine Barcodes on page 175**

All Basic Motion Diagnostics

The **All Basic Motion Diagnostics** diagnostic runs all basic motion tests. Use the figure below to help you with the diagnostic.

All Basic Motion Diagnostics

This will run all basic motion test diagnostics. It typically takes 15 minutes to complete, but can take up to 30 minutes for libraries with multiple frames. Host moves are delayed during each test, but resume between each test.

Run History

| Start Time | End Time | State | Log |
|-----------------------|-----------------------|-----------|--|
| 4/1/2025, 10:58:21 AM | 4/1/2025, 11:02:30 AM | SUCCEEDED | 2025-04-01T17:58:21Z Starting All Basic Motion Test diagnostic. 2025-04-01T17:58:21Z Starting "Shelf Sensor Test" diagnostic. 2025-04-01T17:58:35Z Diagnostic succeeded. 2025-04-01T17:58:35Z "Shelf Sensor Test" diagnostic complete. 2025-04-01T17:58:40Z Starting "Snout Sensor Test" diagnostic. 2025-04-01T17:59:00Z Diagnostic succeeded. 2025-04-01T17:59:00Z "Snout Sensor Test" diagnostic complete. 2025-04-01T17:59:05Z Starting "Exercise TAP Test" diagnostic. 2025-04-01T17:59:20Z Diagnostic succeeded. |

[VIEW FULL LOG ↗](#)

2
 START DIAGNOSTIC

Figure 85 The LumOS All Basic Motion Diagnostics screen.

1. From the diagnostics list, select **All Basic Motion Diagnostics** (not pictured).
2. Click **Start Diagnostic**.

Barcode Reader Test

The **Barcode Reader Test** diagnostic diagnoses potential issues with the transporter barcode reader. Use the figure below to help you with the diagnostic.

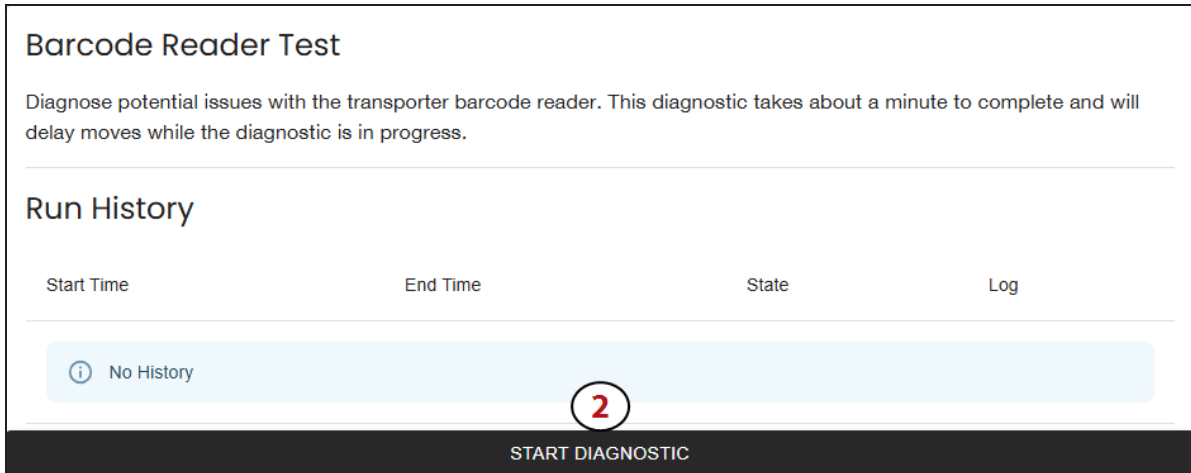

Figure 86 The LumOS Barcode Reader Test screen.

1. From the diagnostics list, select **Barcode Reader Test** (not pictured).
2. Click **Start Diagnostic**.

Bulk TAP Test

The **Bulk TAP Test** diagnostic tests for issues with the Bulk TeraPack Access Ports. Use the figure below to help you with the diagnostic.

Bulk TAP Test

Diagnose issues with the Bulk TeraPack Access Points.

Instructions

After starting diagnostic, walk over to selected TAP and press button (lit green) to open door.

Then, close the door and the test will continue.

Parameters

LEFT BULK

RIGHT BULK

Run History

| Start Time | End Time | State | Log |
|---------------------------|---------------------------|---------|--|
| 12/20/2023, 5:22:05 PM | 12/20/2023, 5:33:30 PM | Expired | Button Before Timeout Expired, Or The Button Is Not Functioning Properly |

START DIAGNOSTIC

Figure 87 The LumOS Bulk TAP Test screen.

1. From the diagnostics list, select **Bulk TAP Test** (not pictured).
2. Use the **Parameters** drop-down menu to select the bulk TAP to test.
3. Click **Start Diagnostic** to run a bulk TAP test.

Delete All Partitions

The **Delete All Partitions** diagnostic deletes all library partitions and assigns all magazines to the free pool before rebooting the library.

Use the figure below to help you with the diagnostic.

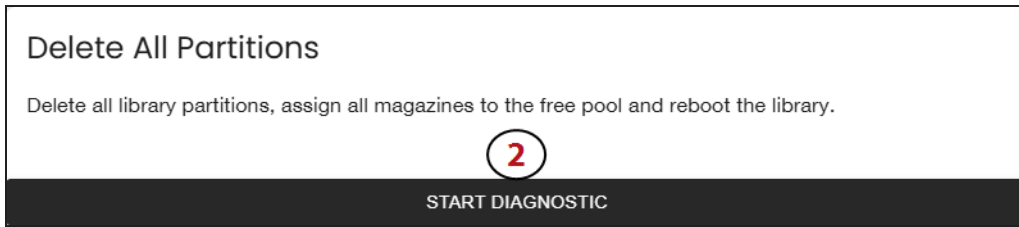

Figure 88 The LumOS Power Cycle Library screen.

1. From the diagnostics list, select **Delete All Partitions** (not pictured).
2. Click **Start Diagnostic**.

Delete Geometry

The **Delete Geometry** diagnostic deletes and rediscover all robotics geometry. All tapes must be removed from tape drives before running this diagnostic.

Use the figure below to help you with the diagnostic.

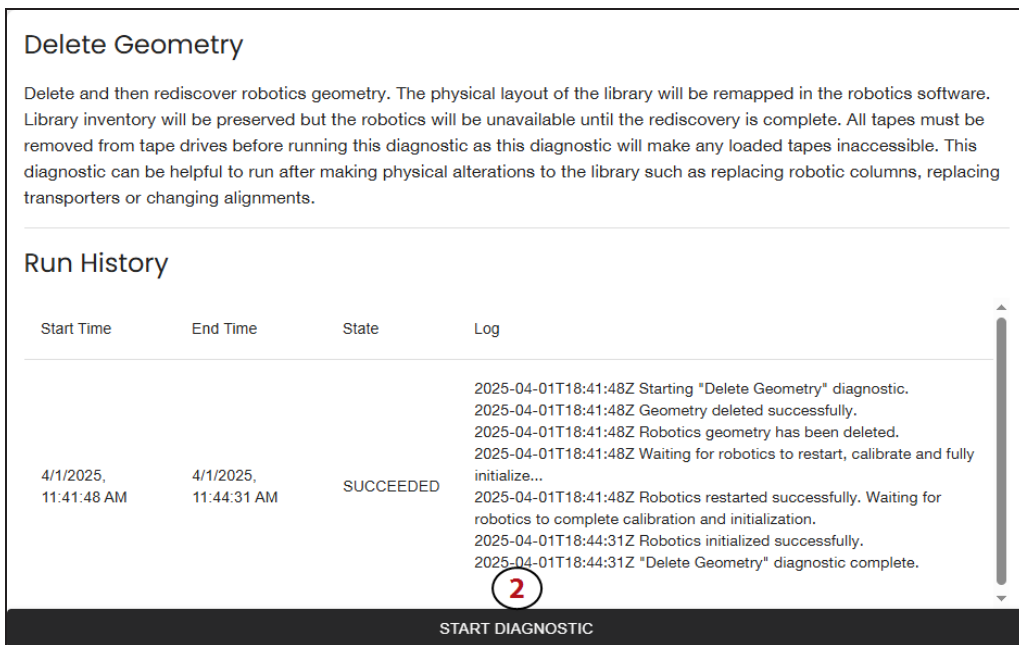

Figure 89 The LumOS Delete Geometry screen.

1. From the diagnostics list, select **Delete Geometry** (not pictured).
2. Click **Start Diagnostic**.

Exercise TAP Diagnostic

Use the **Exercise TAP Diagnostic** to determine potential issues with the main TAP(s). Bulk TAPs will not be tested.

Use the figure below to help you with the diagnostic.

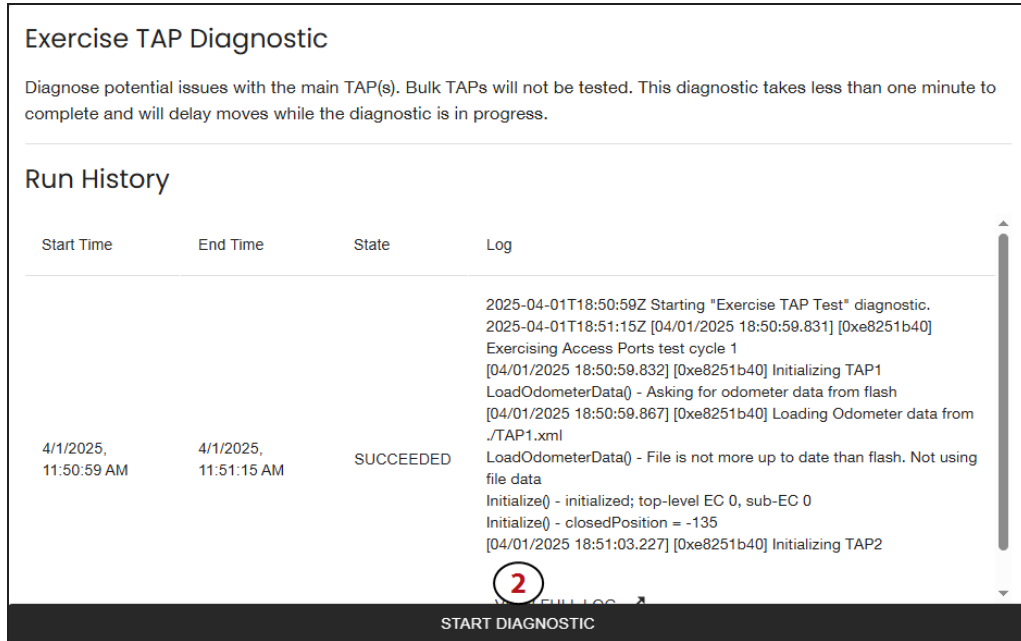

Figure 90 The LumOS Exercise TAP Diagnostic screen.

1. From the diagnostics list, select **Exercise TAP Diagnostic** (not pictured).
2. Click **Start Diagnostic**.

HAX Binding Diagnostic

Use the **HAX Binding Diagnostic** to confirm there are no areas on the HAX that might bind.

Use the figure below to help you with the diagnostic.

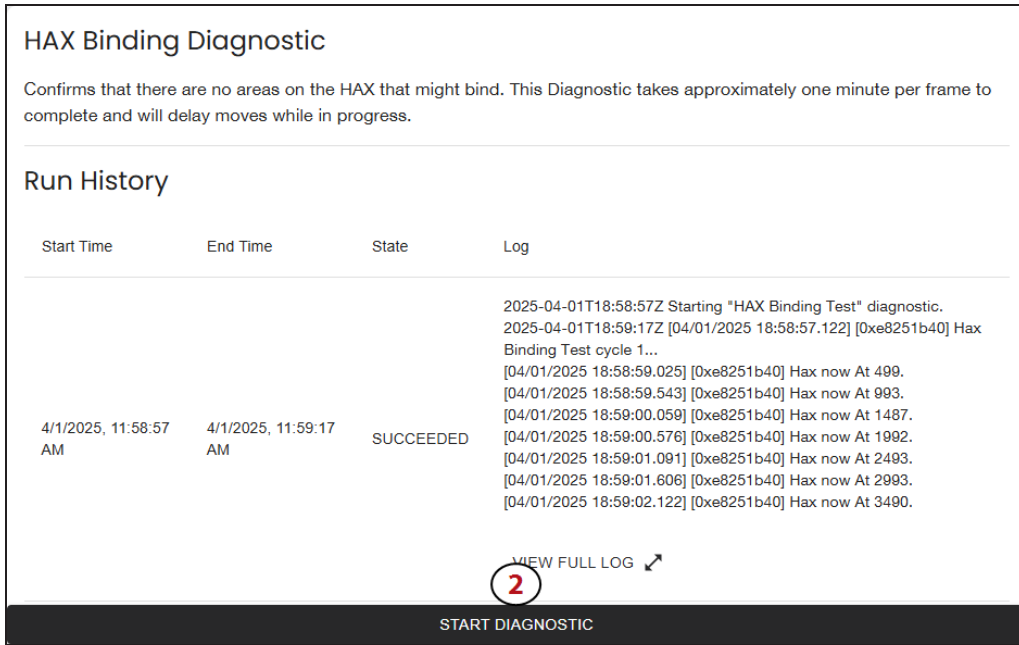

Figure 91 The LumOS HAX Binding Diagnostic screen.

1. From the diagnostics list, select **HAX Binding Diagnostic** (not pictured).
2. Click **Start Diagnostic**.

HAX Sensor Diagnostic

Use the **HAX Sensor Diagnostic** to diagnose potential issues with the robotics HAX sensor. Use the figure below to help you with the diagnostic.

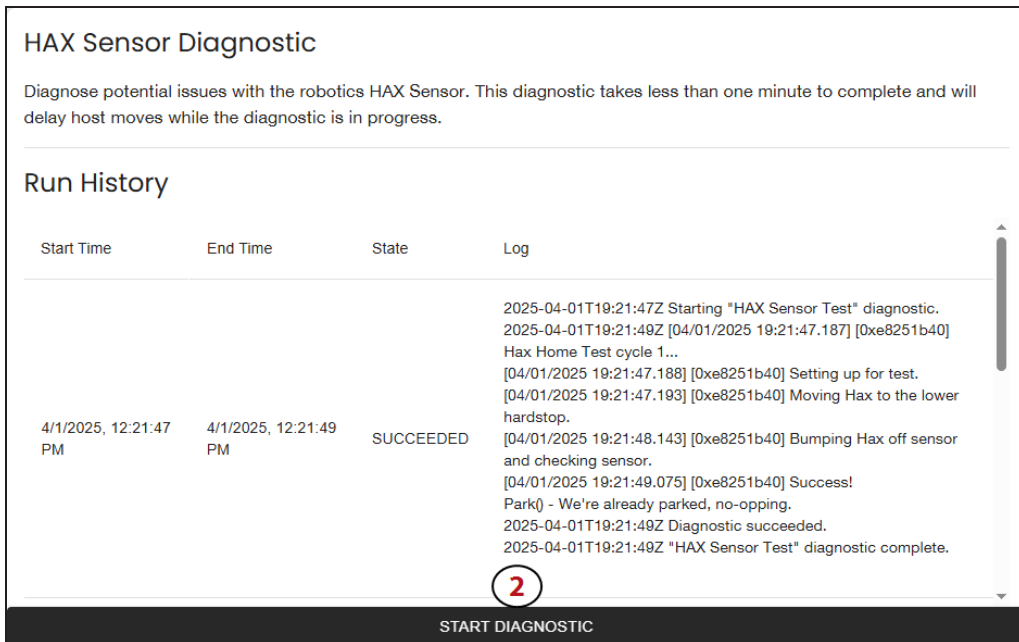

Figure 92 The LumOS HAX Sensor Diagnostic screen.

1. From the diagnostics list, select **HAX Sensor Diagnostic** (not pictured).
2. Click **Start Diagnostic**.

MAX Sensor Diagnostic

Use the **MAX Sensor Diagnostic** to diagnose potential issues with the robotics MAX sensor. Use the figure below to help you with the diagnostic.

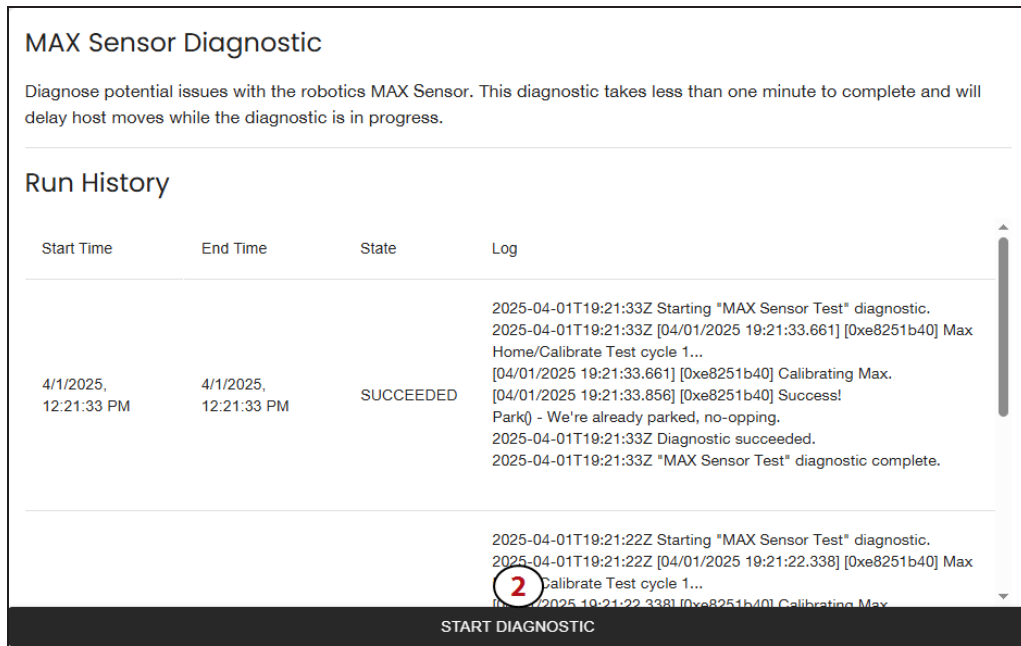

Figure 93 The LumOS MAX Sensor Diagnostic screen.

1. From the diagnostics list, select **MAX Sensor Diagnostic** (not pictured).
2. Click **Start Diagnostic**.

Move to Chambers

The **Move to Chambers** diagnostic moves magazines to and from specified chambers to confirm access to magazines in the specified chambers. Use the figure below to help you with the diagnostic.

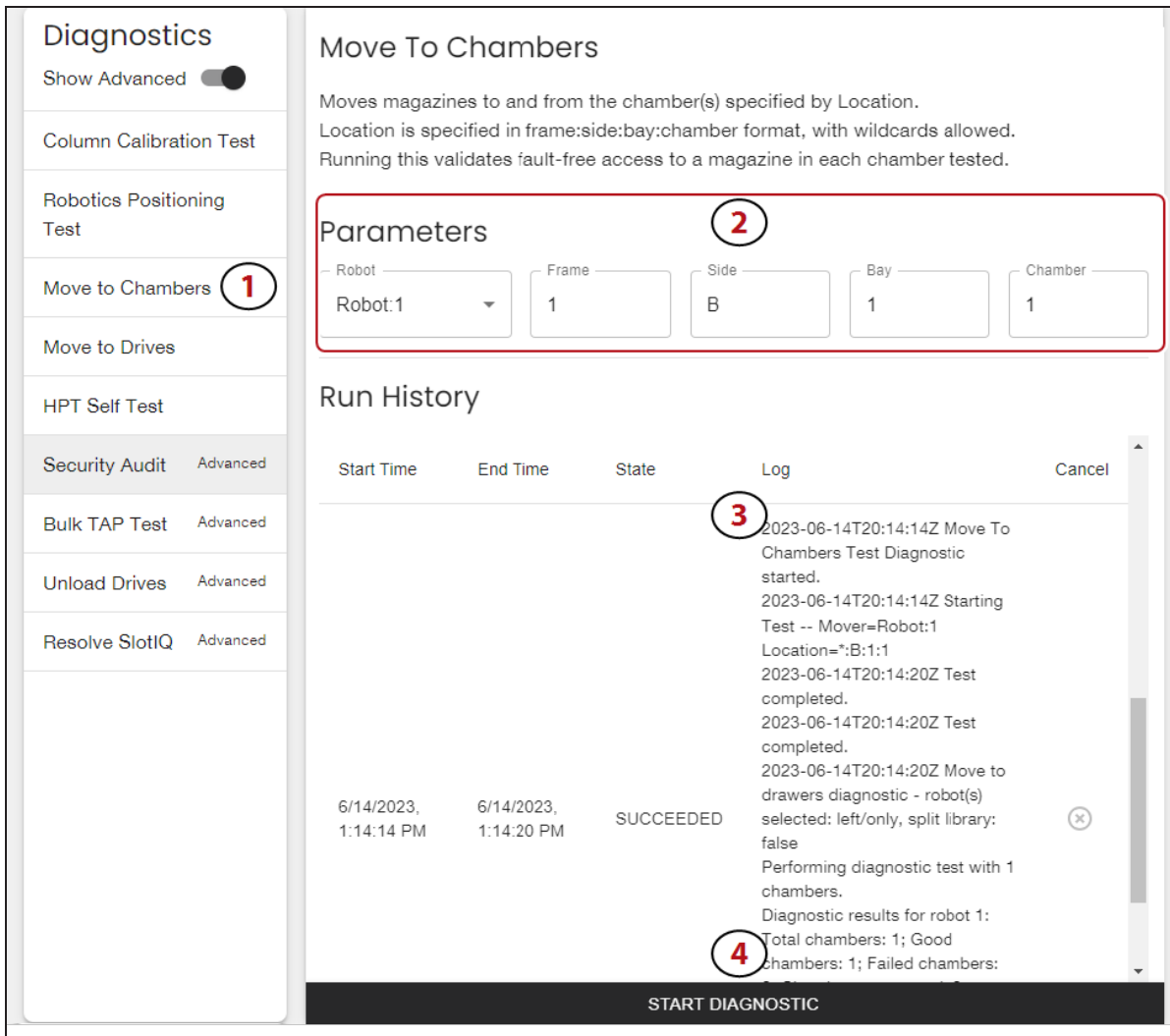

Figure 94 The LumOS Move to Chambers Diagnostic screen.

1. From the diagnostics list, select **Move to Chambers**.
2. Use the **Parameters** drop-down menu to select the robot to test. Enter information for **Frame**, **Side**, **Bay**, and **Chamber** if desired. If you leave a parameter blank, the test runs for all valid values of each parameter.

Note: Side only accepts **F** (front) and **B** (back) as parameters.
3. Use the **Run History** panel to review previous move to chambers test results.
4. Click **Start Diagnostic** to run a move to chambers test using the specified parameters.

Move to Drives

The **Move to Drives** diagnostic moves tape cartridges to and from specified drives to confirm the robotics can access the drives. Use the figure below to help you with the diagnostic.

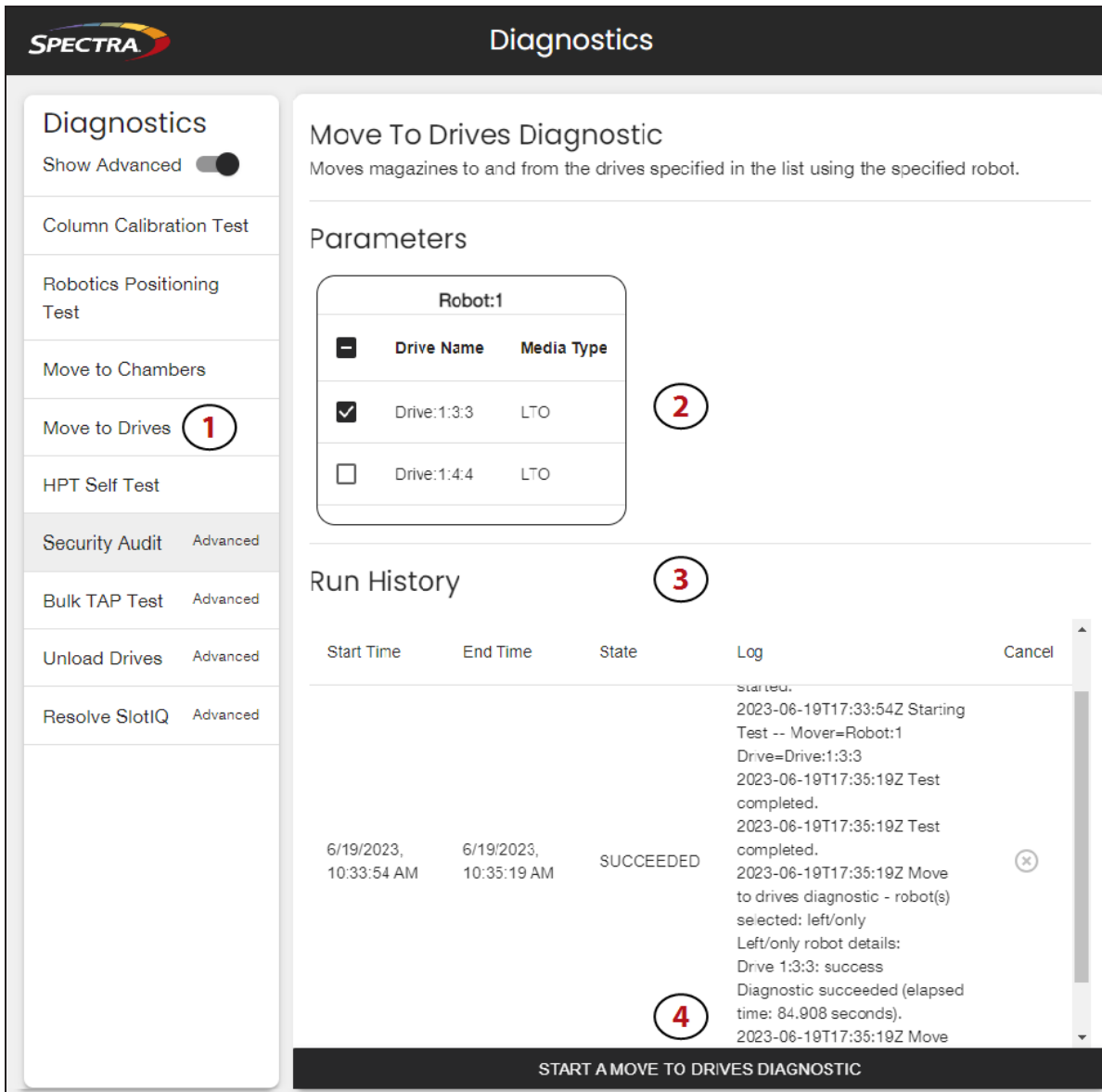

Figure 95 The LumOS Move to Drives Diagnostic screen.

1. From the diagnostics list select **Move to Drives**.
2. Use the **Parameters** menu to select the drives to test.
3. Use the **Run History** panel to review previous move to drives test results.
4. Click **Start Diagnostic** to run the test on the selected drive(s).

Move to Shelf

Use the **Move to Shelf** diagnostic to move the first available TeraPack magazine to all chambers of the specified shelf.

Use the figure below to help you with the diagnostic.

Move To Shelf
Move the first available TeraPack magazine to all chambers of the specified shelf. This diagnostic takes up to 5 minutes to complete. Moves will fail while the diagnostic is running.

Parameters

Frame Number: 1 Shelf Number: 1 Side: Front

Run History

| Start Time | End Time | State | Log | Abort |
|-----------------------|-----------------------|---------|--|-------|
| 4/1/2025, 11:06:45 AM | 4/1/2025, 11:06:59 AM | ABORTED | 2025-04-01T18:06:45Z Starting "Move To Shelf" diagnostic. 2025-04-01T18:06:59Z Diagnostic aborted. 2025-04-01T18:06:59Z "Move To Shelf" diagnostic complete. task a | ✕ |

START DIAGNOSTIC

Figure 96 The LumOS MAX Sensor Diagnostic screen.

1. From the diagnostics list, select **MAX Sensor Diagnostic** (not pictured).
2. Enter a **Frame Number** and **Shelf Number**. Use the **Side** drop-down menu to select the side to test.
3. Click **Start Diagnostic**.

Obstruction Scan

Use the **Obstruction Scan** diagnostic to scan for potential obstructions to robotic movement.

Use the figure below to help you with the diagnostic.

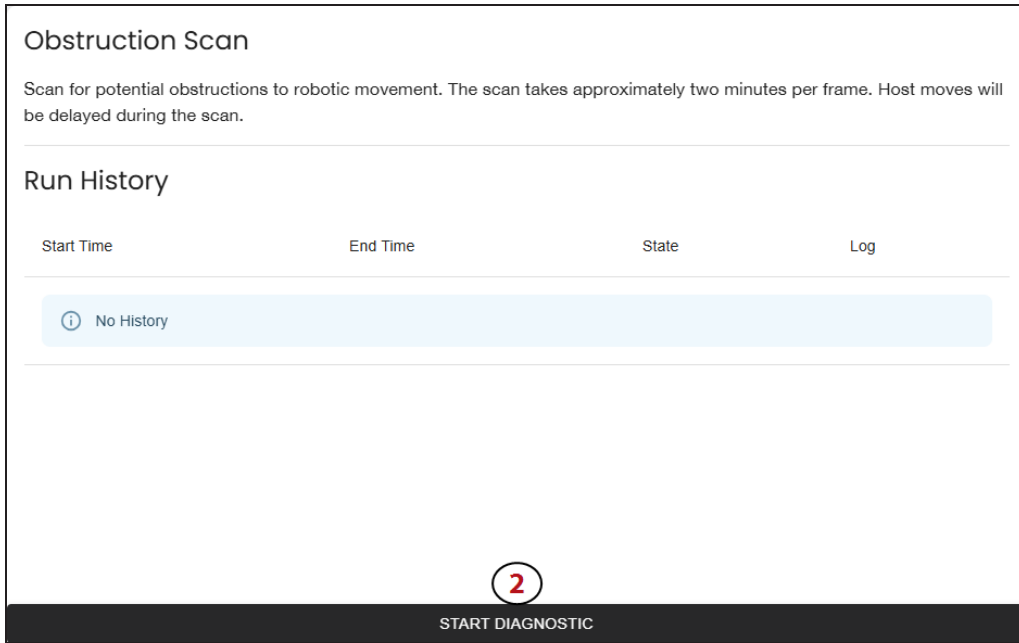

Figure 97 The LumOS Obstruction Scan screen.

1. From the diagnostics list, select **Obstruction Scan** (not pictured).
2. Click **Start Diagnostic**.

PAX Sensor Diagnostic

Use the **PAX Sensor Diagnostic** to diagnose potential issues with the robotics PAX sensor. Use the figure below to help you with the diagnostic.

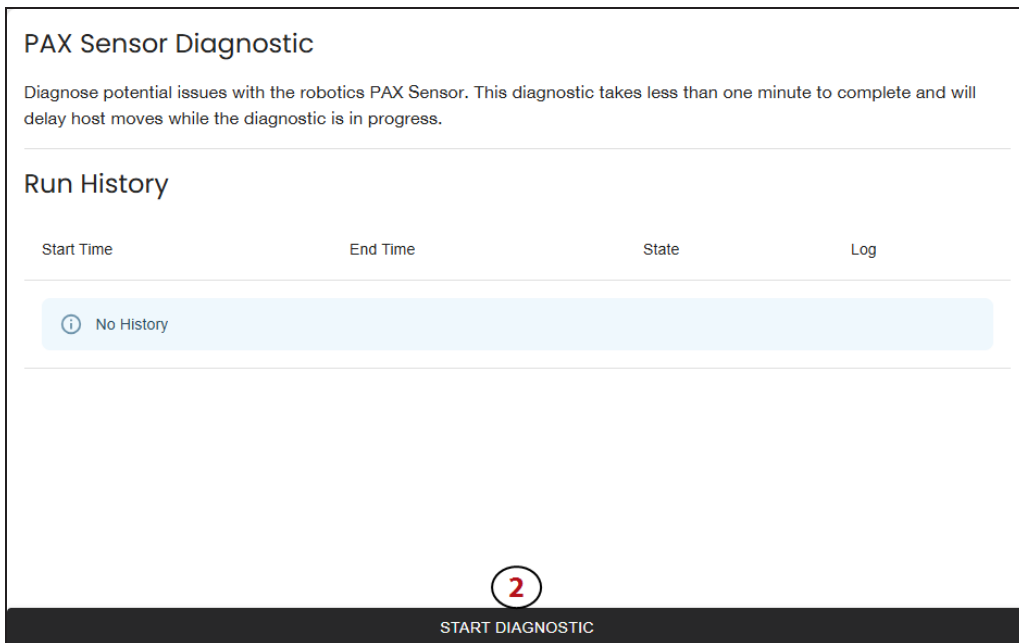

Figure 98 The LumOS PAX Sensor Diagnostic screen.

1. From the diagnostics list, select **PAX Sensor Diagnostic** (not pictured).
2. Click **Start Diagnostic**.

Power Cycle Library

The Power Cycle Library diagnostic gracefully shuts down the library robotics and then cycles library power after a 45 second delay.

Use the figure below to help you with the diagnostic.

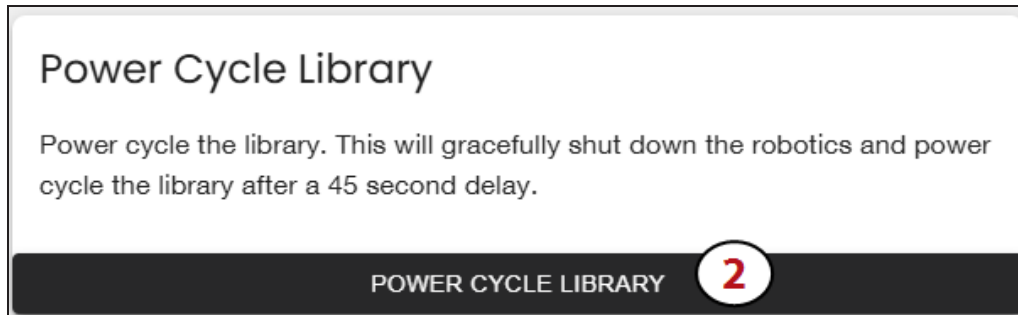

Figure 99 The LumOS Power Cycle Library screen.

1. From the diagnostics list, select **Power Cycle Library** (not pictured).
2. Click **Power Cycle Library**.

RAX Sensor Diagnostic

Use the **RAX Sensor Diagnostic** to diagnose potential issues with the robotics RAX sensor.

Use the figure below to help you with the diagnostic.

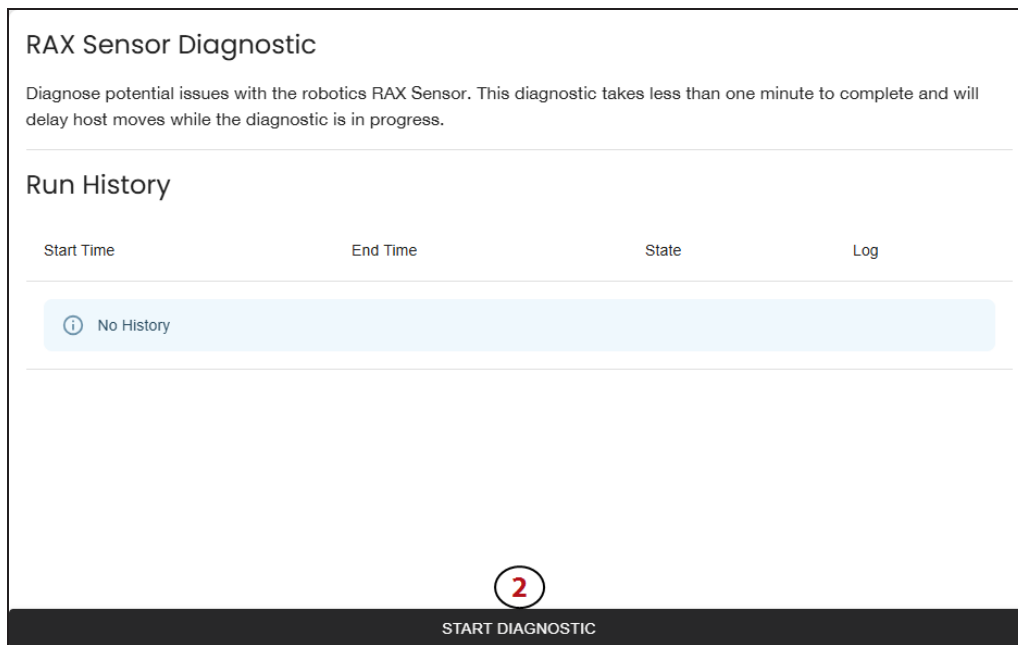

Figure 100 The LumOS RAX Sensor Diagnostic screen.

1. From the diagnostics list, select **RAX Sensor Diagnostic** (not pictured).
2. Click **Start Diagnostic**.

Reset Geometry

Use the **Reset Geometry** diagnostic to reset the calibrated state of each drive and chamber, forcing the drive or chamber to recalibrate on next access.

Use the figure below to help you with the diagnostic.

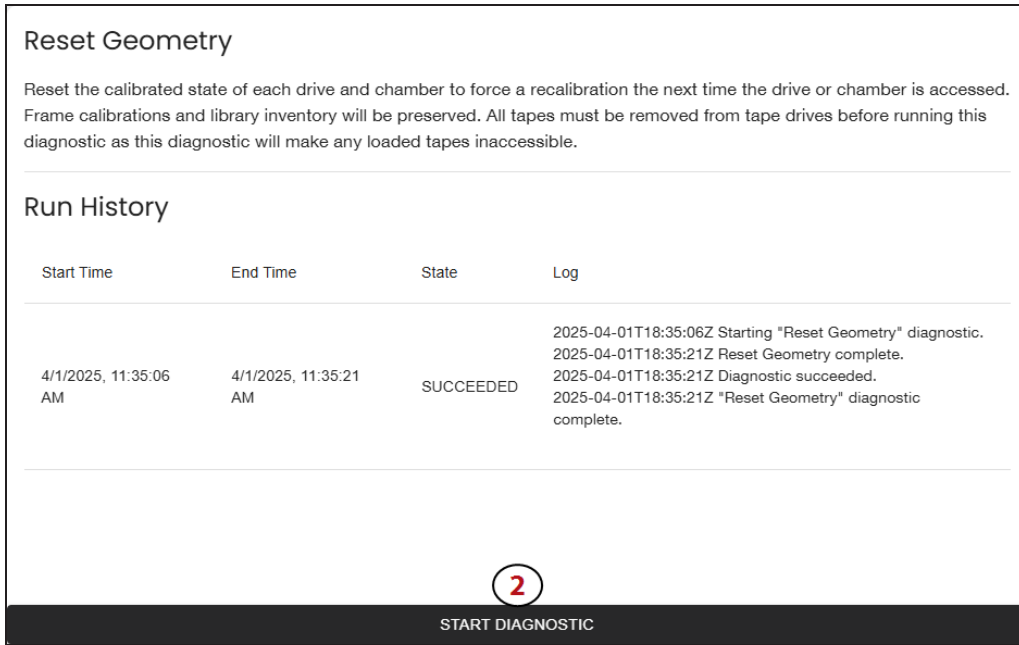

Figure 101 The LumOS Reset Geometry screen.

1. From the diagnostics list, select **Reset Geometry** (not pictured).
2. Click **Start Diagnostic**.

Reset Inventory

The Reset Inventory diagnostic allows users to reset the library inventory. After you reset the library inventory, the library scans all tape cartridges in each TeraPack magazine to establish a new inventory. This can take a long time on large libraries.

Use the figure below to help you with the diagnostic.

Note: Reset Inventory is an advanced diagnostic. Advanced diagnostics can significantly impact normal library operation. Spectra Logic recommends contacting Spectra Logic Technical Support before resetting the library inventory.

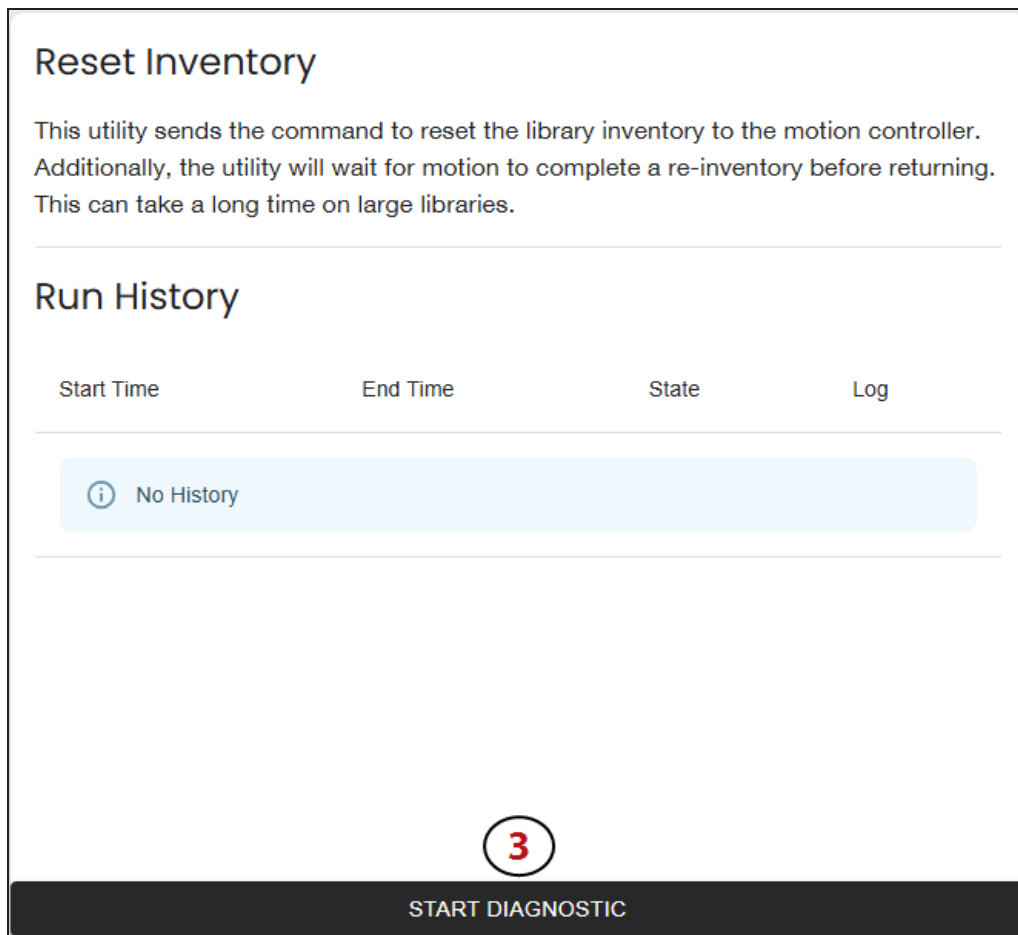

Figure 102 The LumOS Reset Inventory screen.

1. From the diagnostics list, select **Reset Inventory** (not pictured).
2. Click **Start Diagnostic**.

Robotics Positioning Test

The **Robotics Positioning Test** diagnostic tests for robot positioning issues. Use the figure below to help you with the diagnostic.

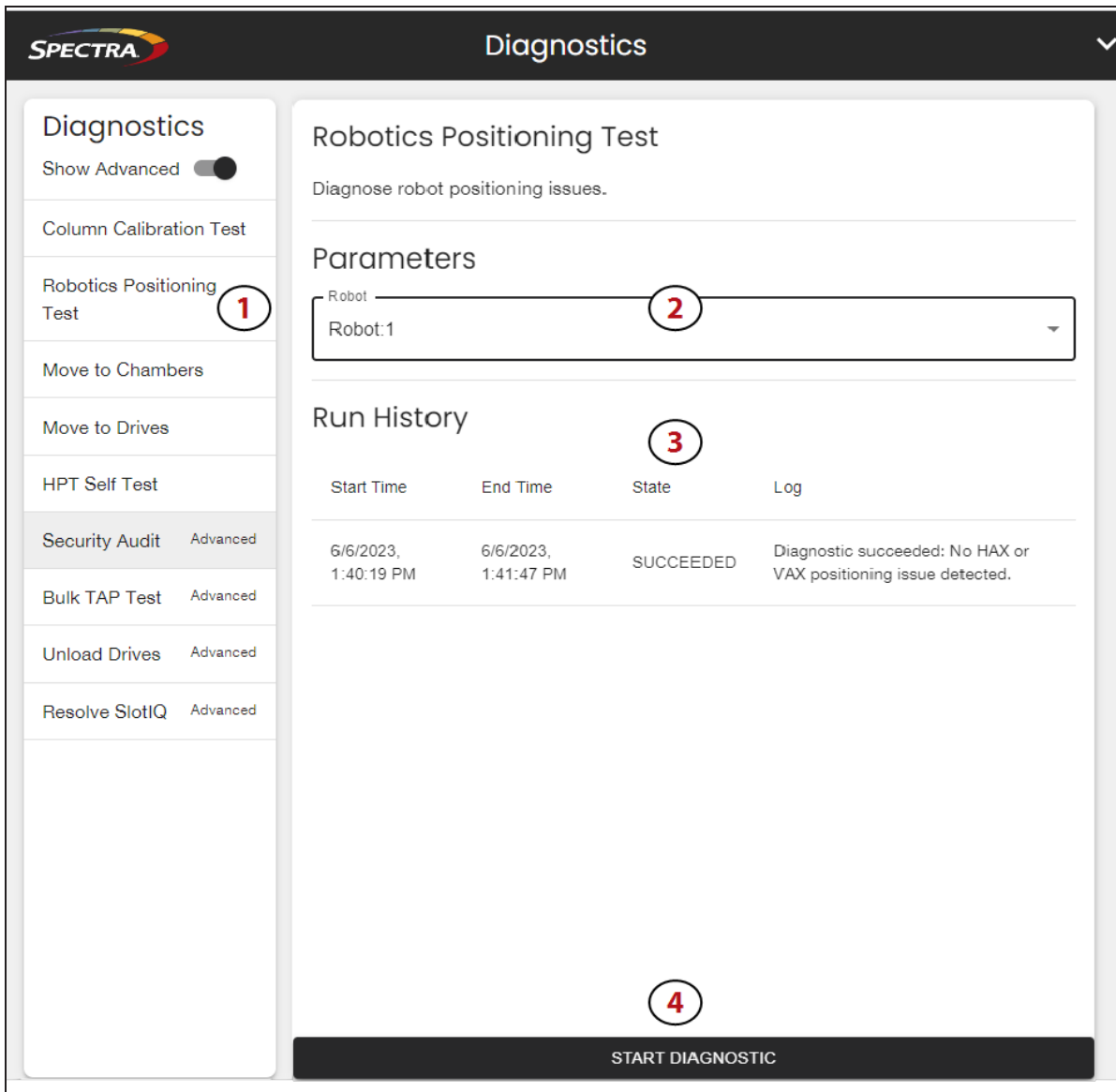

Figure 103 The LumOS Robotics Positioning Diagnostic screen.

1. From the diagnostics list, select **Robotics Positioning Test**.
2. Use the **Parameters** drop-down menu to select the robot to test.
3. Use the **Run History** panel to review previous robotics positioning test results.
4. Click **Start Diagnostic** to run a robotics positioning test on the selected robot.

SAX Sensor Diagnostic

Use the **SAX Sensor Diagnostic** to diagnose potential issues with the robotics SAX sensor. Use the figure below to help you with the diagnostic.

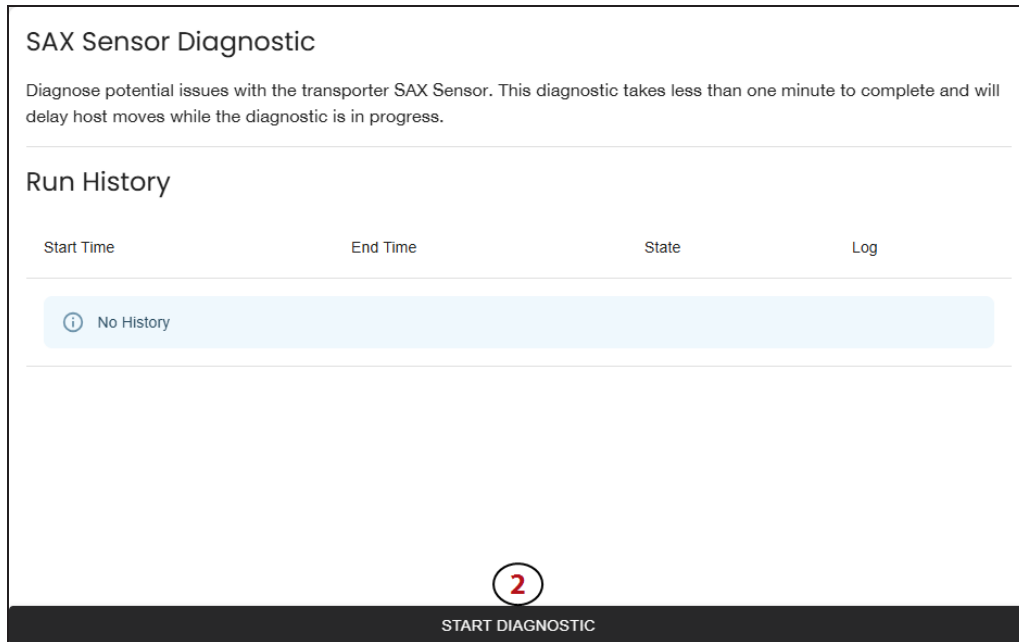

Figure 104 The LumOS SAX Sensor Diagnostic screen.

1. From the diagnostics list, select **SAX Sensor Diagnostic** (not pictured).
2. Click **Start Diagnostic**.

Shelf Sensor Test

Use the **Shelf Sensor Test** to diagnose potential issues with the transporter shelf sensors. Use the figure below to help you with the diagnostic.

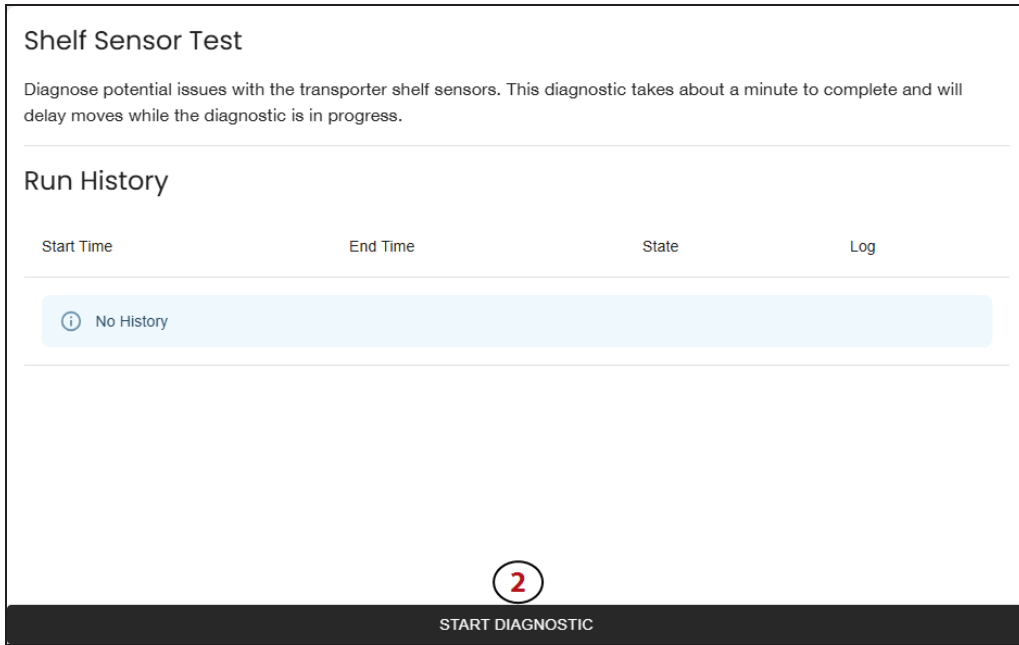

Figure 105 The LumOS Shelf Sensor Test screen.

1. From the diagnostics list, select **Shelf Sensor Test** (not pictured).
2. Click **Start Diagnostic**.

Snout Sensor Test

Use the **Snout Sensor Test** to diagnose potential issues with the robot shelf sensors. Use the figure below to help you with the diagnostic.

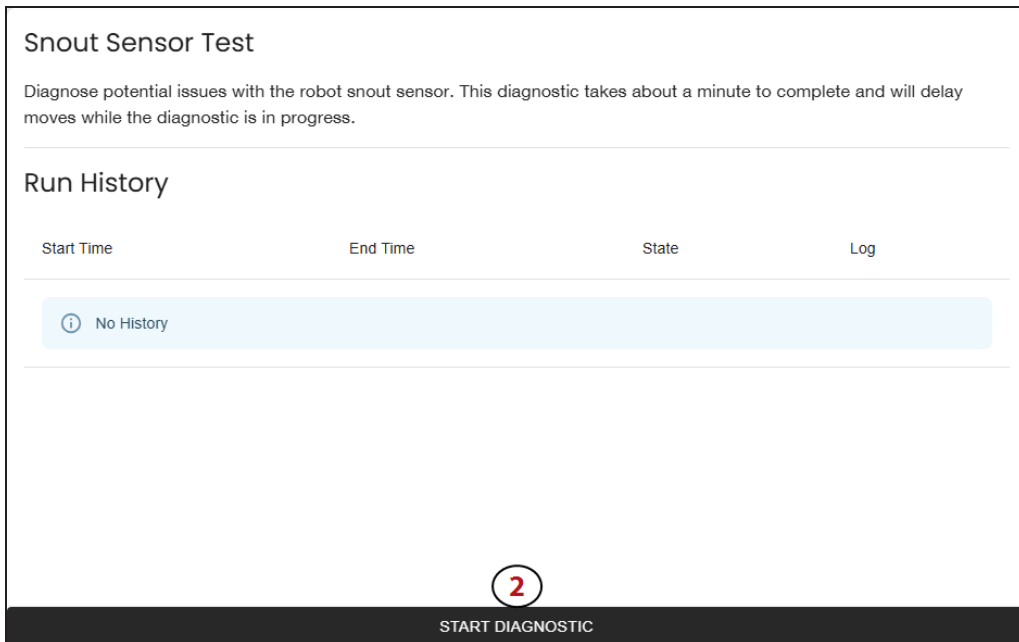

Figure 106 The LumOS Snout Sensor Test screen.

1. From the diagnostics list, select **Snout Sensor Test** (not pictured).
2. Click **Start Diagnostic**.

Security Audit

The **Security Audit** diagnostic verifies the barcode and position of each TeraPack magazine and tape cartridge in the library. Use the figure below to help you with the diagnostic.



IMPORTANT

The Security Audit diagnostic takes longer the more magazines and tape cartridges are present in the library.

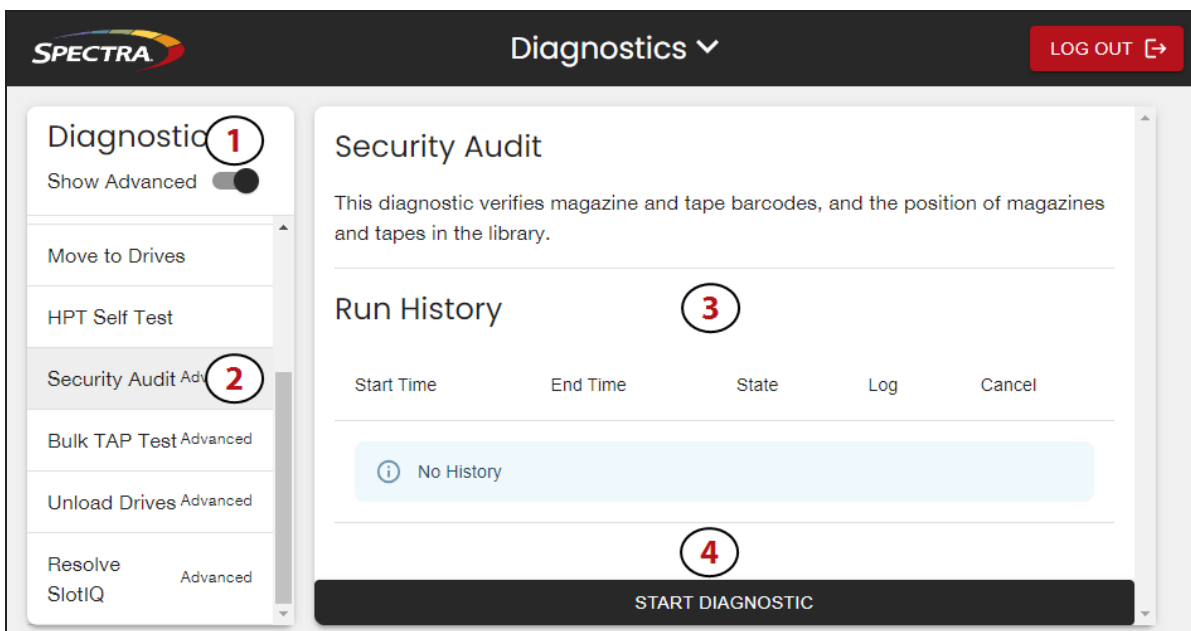

Figure 107 The LumOS Security Audit Diagnostic screen.

1. From the diagnostics list, select **Security Audit**.
2. Use the **Run History** panel to review previous security audit results.
3. Click **Start Diagnostic** to begin the security audit. The duration of this diagnostic depends on the size of the library and number of TeraPack magazines installed in the library.

TAX 50/50 Sensor Diagnostic

Use the **TAX 50/50 Sensor Diagnostic** to diagnose potential issues with the robotics TAX 50/50 sensor.

Use the figure below to help you with the diagnostic.

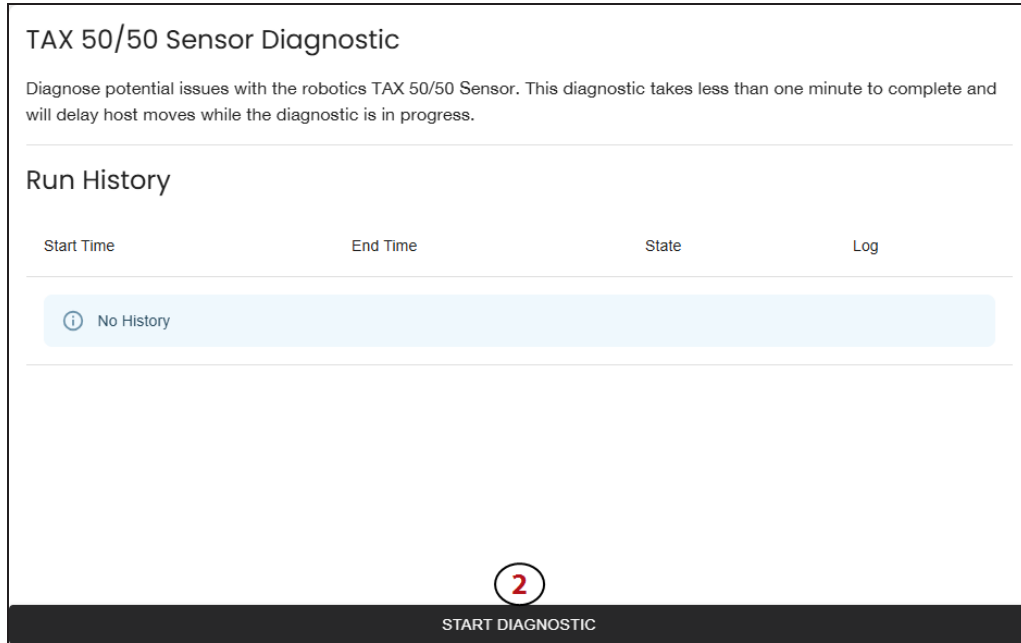

Figure 108 The LumOS TAX 50/50 Sensor Diagnostic screen.

1. From the diagnostics list, select **TAX 50/50 Sensor Diagnostic** (not pictured).
2. Click **Start Diagnostic**.

TAX TeraPack Sensor Diagnostic

Use the **TAX TeraPack Sensor Diagnostic** to diagnose potential issues with the robotics TAX magazine sensor.

Use the figure below to help you with the diagnostic.

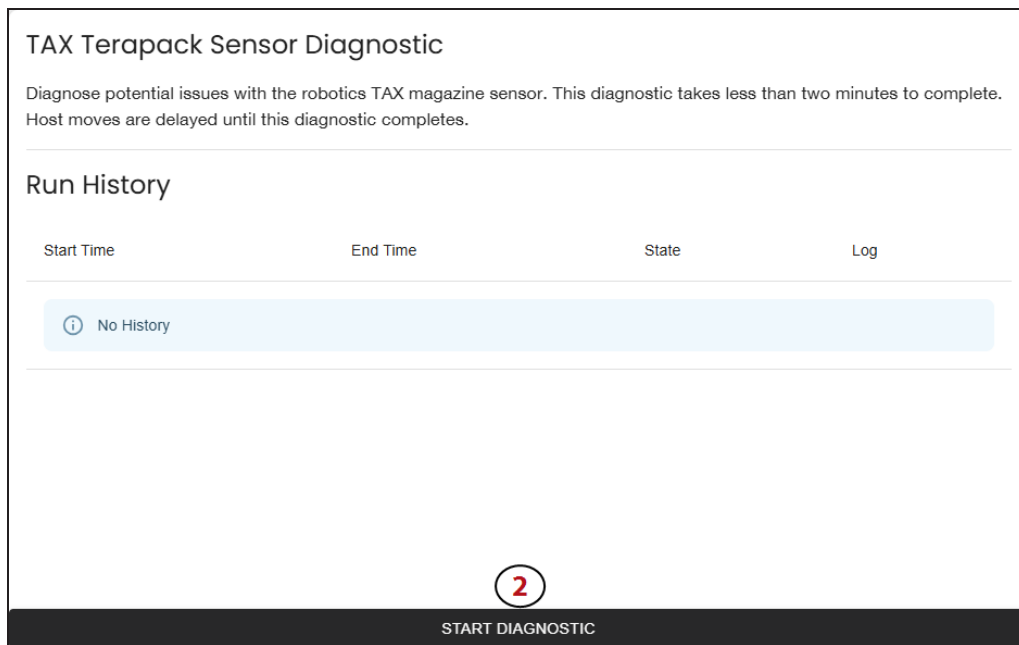

Figure 109 The LumOS TAX TeraPack Sensor Diagnostic screen.

1. From the diagnostics list, select **TAX TeraPack Sensor Diagnostic** (not pictured).
2. Click **Start Diagnostic**.

Unload Drives

The Unload Drives diagnostic allows users to unload all drives in the library or in a specific partition. Use the figure below to help you with the diagnostic.

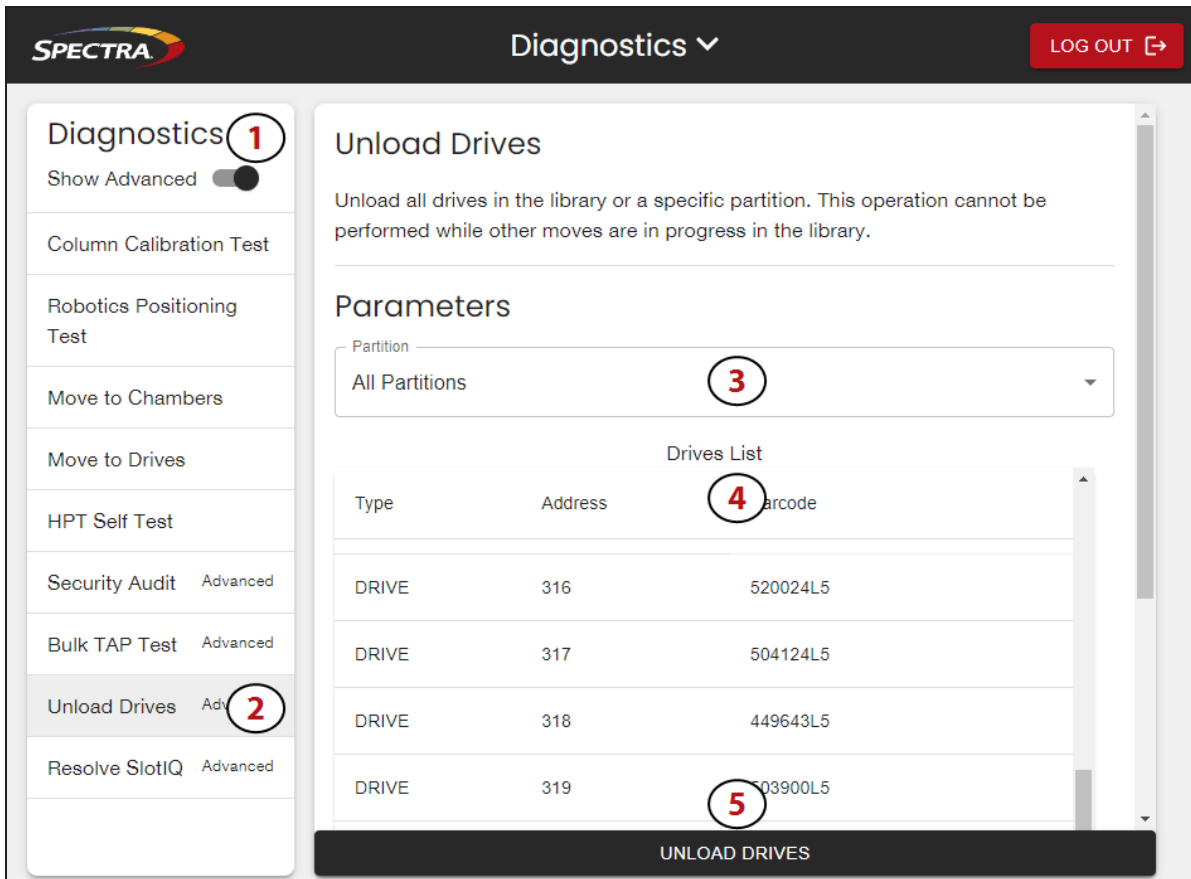

Figure 110 The LumOS Unload Drives screen.

1. From the diagnostics list, select **Unload Drives**.
2. Use the **Parameters** drop-down menu to select the desired partition, or select **All Partitions**.
3. Use the **Drives List** panel to review all selected drives.
4. Click **Unload Drives**.

VAX Column Alignment Diagnostic

Use the **VAX Column Alignment Diagnostic** to confirm the vertical alignment of the robotics assembly is within an acceptable range. Check with Spectra Logic Technical Support or the FRU guide to confirm if a value is acceptable.

Use the figure below to help you with the diagnostic.

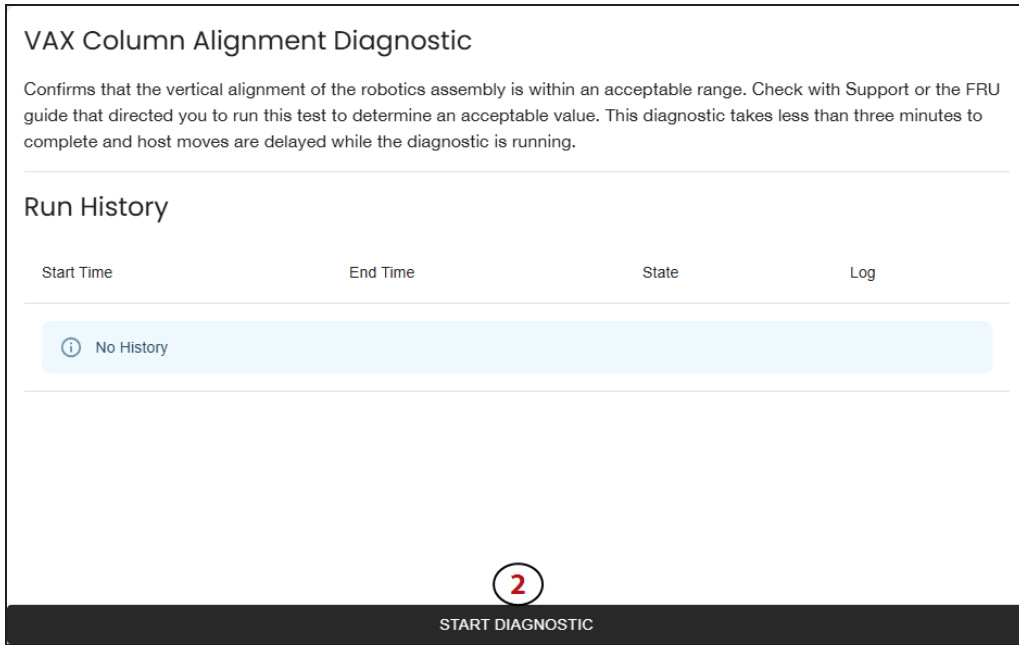

Figure 111 The LumOS VAX Column Alignment Diagnostic screen.

1. From the diagnostics list, select **VAX Column Alignment Diagnostic** (not pictured).
2. Click **Start Diagnostic**.

VAX Sensor Diagnostic

Use the **VAX Sensor Diagnostic** to diagnose potential issues with the robotics VAX sensor. Use the figure below to help you with the diagnostic.

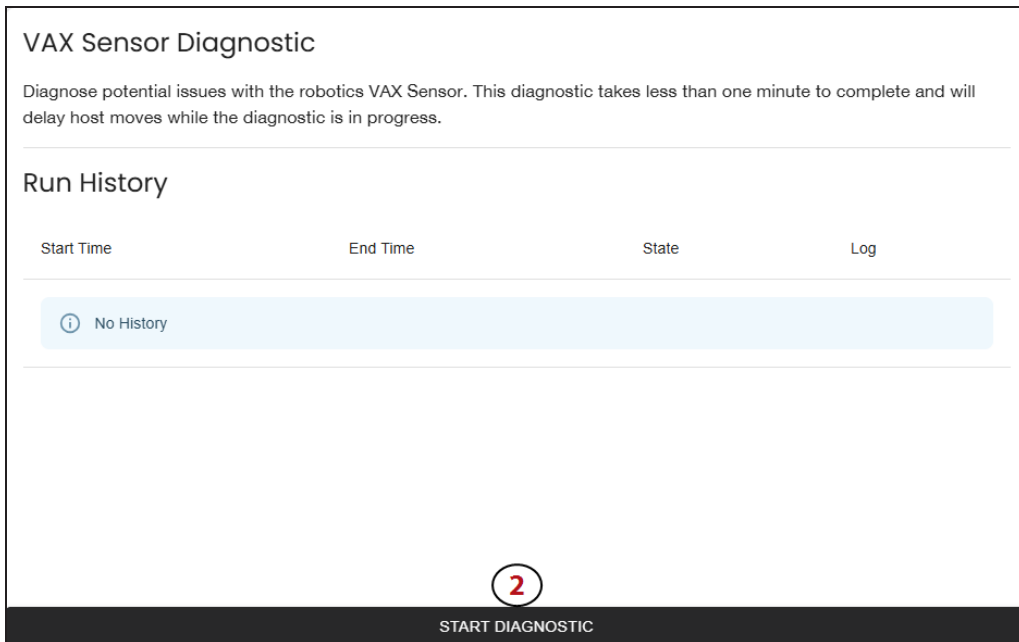

Figure 112 The LumOS VAX Sensor Diagnostic screen.

1. From the diagnostics list, select **VAX Sensor Diagnostic** (not pictured).
2. Click **Start Diagnostic**.

Verify Magazine Barcodes

Use the **Verify Magazine Barcodes** diagnostic to check all magazine barcodes and their locations against the library inventory.

Use the figure below to help you with the diagnostic.

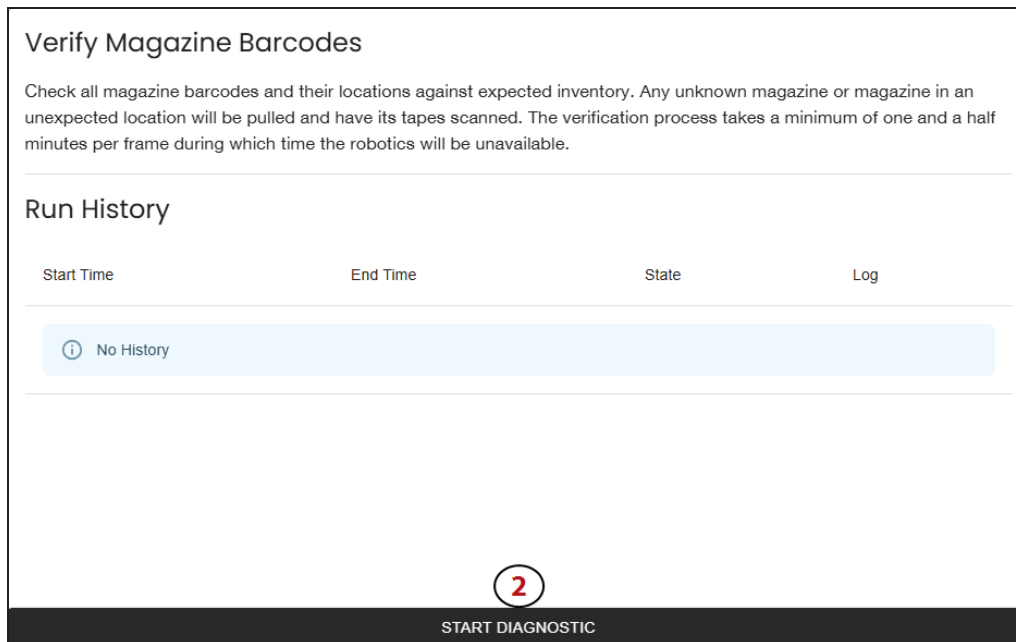

Figure 113 The LumOS Verify Magazine Barcodes screen.

1. From the diagnostics list, select **Verify Magazine Barcodes** (not pictured).
2. Click **Start Diagnostic**.

ALERTS

The Alerts features allows the library to automatically notify configured users when specific events occur. Additionally, you can configure the library to send alerts and AutoSupport Log (ASL) files to Spectra Logic Technical Support when a critical event occurs.

Note: AutoSupport Log (ASL) information is only for troubleshooting purposes. This log information is separate from the data path and contains no customer data.

An AutoSupport Log file contains the following types of information:

- Library message logs
- Library Control Module (LCM) logs
- LCM configuration
- The physical configuration of the library
- A simplified report of the MLM and DLM databases
- EC data from all components
- LumOS version
- Contact information for data center staff

The library generates a critical alert when any of the following issues occur.

| Event | A critical alert is generated when... |
|-----------------------------|--|
| Motion Restart | Whenever motion restarts. Each motion restart is treated as a separate event and results in generation of an alert. |
| Side Panel Removed | If a library side panel is opened or removed three times within 30 minutes. Only one alert is generated for each 30-minute time period. |
| Power Supply Failure | When a power supply fails. Each power supply is evaluated separately. Only one alert per power supply is generated for each 24-hour time period, even if the power supply fails and then resumes operation repeatedly. If two power supplies fail during the same 24-hour time period, two separate alerts are generated, one per failed power supply. |
| RIM Failure | <p>Whenever the library detects that a RIM is no longer present. Only RIMs that are configured as part of a partition will generate an alert.</p> <p>The following problems can generate a RIM failure event:</p> <ul style="list-style-type: none"> • Failure of the RIM software or hardware. • Loss of communication between the library and the RIM. • Removal of a RIM from the library. |

| Event | A critical alert is generated when... |
|----------------------|---|
| | Each RIM is evaluated separately. Only one alert per RIM is generated for each 24-hour time period, even if the RIM fails and then resumes operation repeatedly. If two RIMs fail during the same 24-hour time period, two separate alerts are generated, one per failed RIM. |
| Drive Failure | <p>When the library detects a drive failure that results in the percentage of failed drives in a partition meeting or exceeding the specified threshold.</p> <p>The following drive problems can generate a drive failure event:</p> <ul style="list-style-type: none"> • Failure of the drive software or hardware. • Loss of communication between the library and the drive. • Removal of a drive from the library without using the Drive Remove or Drive Replace operation. |

Overview

This section describes enabling email alerts for drive failure notifications using the LumOS user interface. Log into the LumOS user interface and select **Tools > Alerts**.

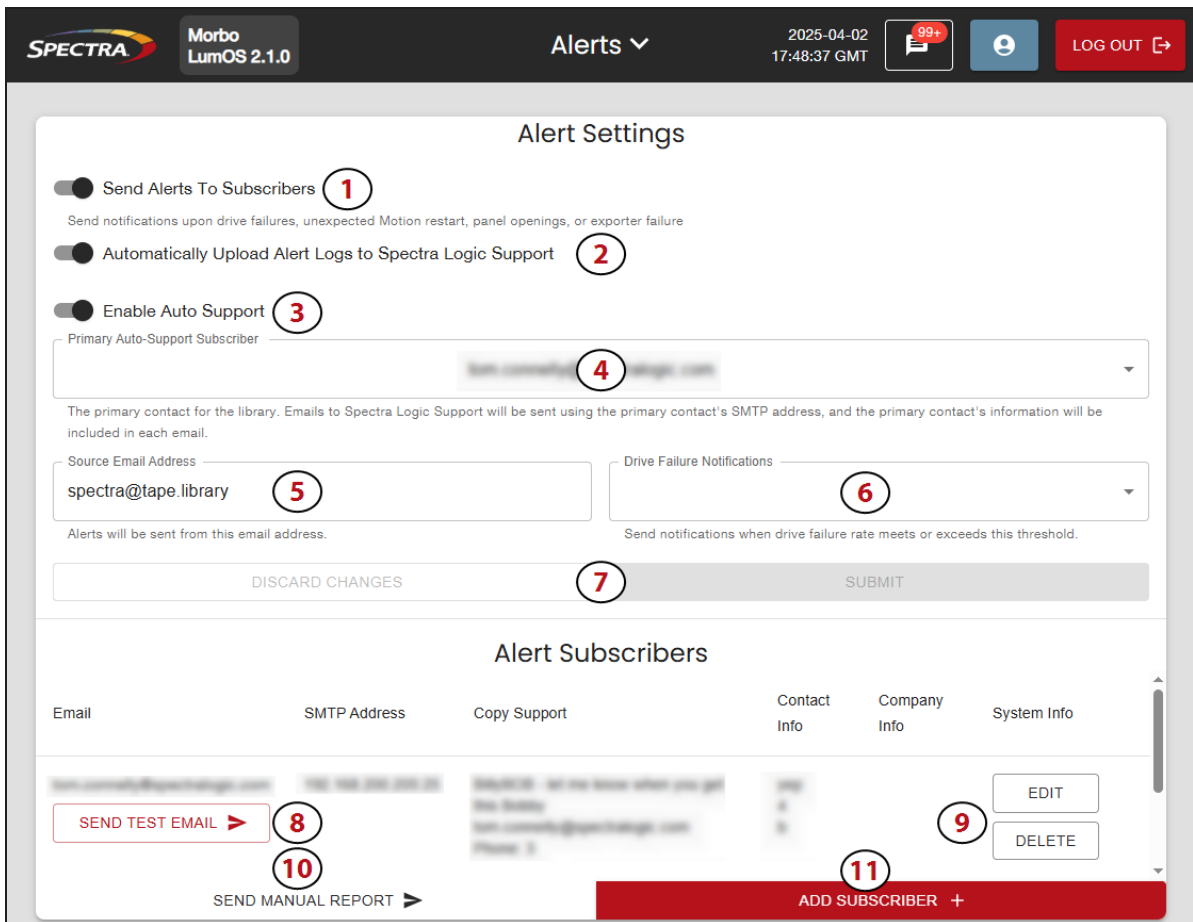

Figure 114 The LumOS Alerts screen.

Configuring Alerts

The following section describes the steps to enable and configure alerts. Use [Figure 114](#) to help you complete the steps below.

1. Toggle **Send Alerts To Subscribers** if desired.
2. Toggle **Automatically Upload Usage and Diagnostic Data to Spectra Logic Support** if desired. If you enable this option, whenever the library generates an alert, logs are automatically sent to Spectra Logic Technical Support.

Note: To send diagnostic data automatically, your firewall must be configured to allow traffic to the following domains:

- <https://www.filestackapi.com>
- <https://loki.spectralogic.com>

3. Toggle **Enable Auto Support** if desired.
4. With auto-support enabled, use the drop-down menu to select a **Primary Auto-Support Subscriber**.
5. Enter a **Source Email Address** to send auto alerts.
Note: `spectra@tape.library` is a placeholder address that must be overwritten with a valid email address.
6. Use the **Drive Failure Notifications** drop-down menu to select a Drive Health threshold to send an alert. The Drive Health threshold is defined as the percentage of drives from all partitions reporting failures.
7. Click **Submit Changes** to apply your selected alert settings.
8. Click **Send Test Email** to send a test email to the configured alert subscriber.
9. Click **Edit** or **Delete** to edit or delete the configured alert subscriber.
10. Click **Send Manual Report** to manually generate and send an alert report.
11. Click **Add Subscriber** to add a new alert subscriber.

Adding or Editing Alert Subscribers

The screenshot shows a mobile application interface for adding a subscriber. At the top, there's a title bar with 'Add a Subscriber' and a close button. Below it, there are three main sections. The first section has an 'Email Address *' field with a red circle '1' next to it, and a 'Required' label below. The second section has an 'SMTP Address' field with a red circle '2' next to it, and a 'Required' label below. The third section has a toggle switch for 'Copy Events to Spectra Support' with a red circle '3' next to it. Below this is a section titled 'Subscriber Contact Information' which is enclosed in a red border. This section contains four input fields: 'First Name' (Required), 'Last Name' (Required), 'Email Address *' (Required, with a red circle '4' next to it), and 'Phone Number' (Required). There is also an 'Alternate Phone' field at the bottom of this section. A 'SUBMIT' button is located at the bottom right of the form.

Figure 115 The LumOS Add Subscriber screen.

The following section describes the steps to add alert subscribers or to edit an existing alert subscriber. Click **Add A Subscriber +** to begin adding a new alert subscriber, or click **Edit** next to an existing alert subscriber then use [Figure 115](#) to help you complete the steps below.

1. Enter an **Email Address**.
2. Enter a **SMTP Address**.

Notes:

- The library currently only supports port 25.

- SMTP servers are required to support TLS and to access the email alert system.

3. Toggle **Copy Events to Spectra Support** if desired to include Spectra Support on event alerts.
4. Enter the required **Subscriber Contact Information**. Optionally, enter information in the **Alternate Phone** field.

The screenshot shows a mobile application interface for adding a subscriber. At the top, there is a title bar with the text 'Add a Subscriber' and a close button (X). Below the title bar, the form is organized into two main sections: 'Company Information' and 'System Info'. The 'Company Information' section contains three input fields: 'Name' (with the value 'Example Company'), 'Address' (with the value '999 Example St'), and 'Location'. The 'System Info' section contains three input fields: 'Operating System', 'Backup Software', and 'Notes'. A red box highlights the 'Company Information' section, and a red circle with the number 5 is placed over the 'Address' field. Another red circle with the number 6 is placed over the 'Backup Software' field. A red circle with the number 7 is placed over the 'SUBMIT' button at the bottom right of the form.

Figure 116 The LumOS Add Subscriber screen.

5. Enter the required **Company Information**. Optionally, enter information in the **Location** field.
6. If desired, enter information in the **System Info** fields.
7. When all required fields are complete, click **Submit**.

LOG GATHERING

The LumOS user interface allows you to gather logs from the T950 library. To gather a log, log in to the library and navigate to **Tools > Log Gather**.

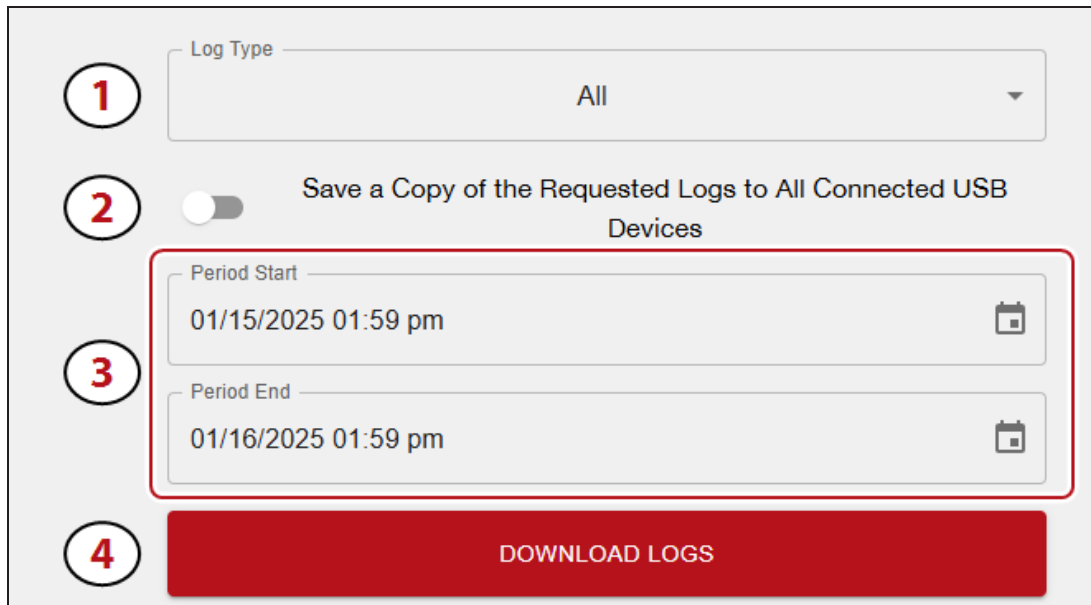

Figure 117 The LumOS Log Gather screen.

Gathering Logs

To gather logs:

1. Select the desired **Log Type** from the drop-down menu to gather. Supported log types include:
 - All
 - API Responses
 - CAN
 - Dip E
 - Drive
 - Loglib
 - LumOS
 - Motion
 - MySQL
 - OS
2. If desired, toggle the slider to save a copy of the log file(s) to a USB drive connected to the library.
3. Click the calendar icon to select the **Period Start** and **Period End** range.
4. Click **Initiate Log Gather**.

MANAGING BACKUPS

Overview

Keeping valid backup copies of your library's configuration ensures that you can easily restore the library in the event of a disaster. Library backups are extremely useful if problems require you to replace the LCM by allowing you to restore the library settings, including partitions, instead of having to manually re-enter all of the information.

Create and Download Backup

The LumOS user interface allows you to create and download backups on your T950 library or local machine. Log in and navigate to **Tools > Backup Restore**.

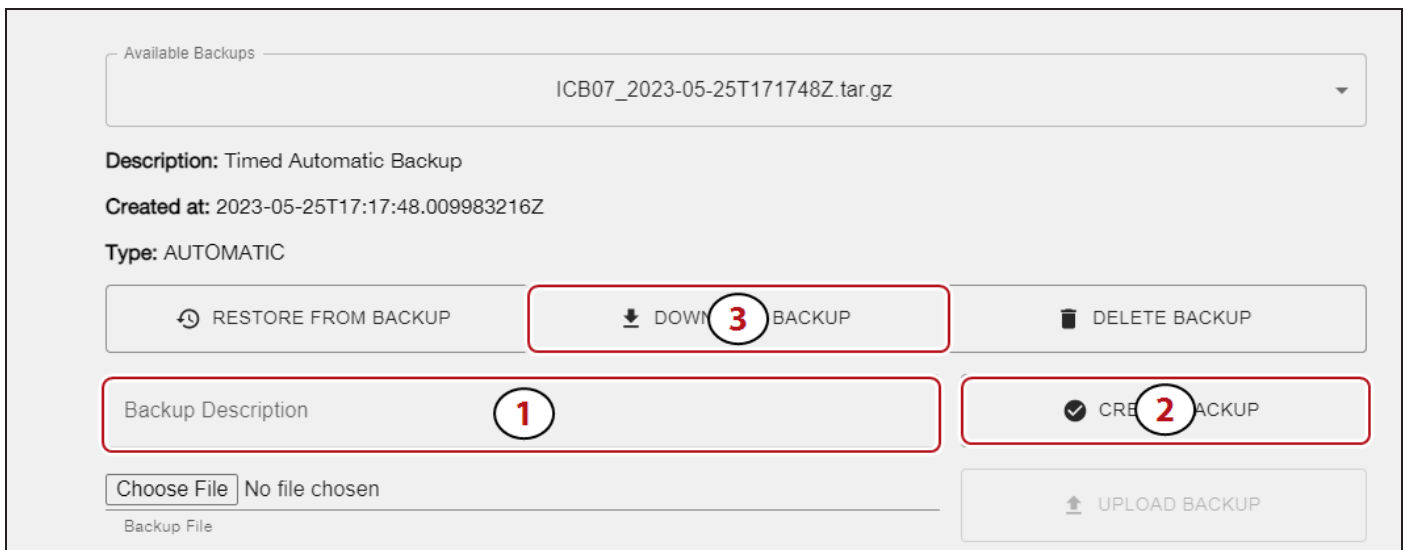

Figure 118 The LumOS Backup Restore screen.

Use the numbers in the figure above to help you with the following steps:

1. To create a new backup, enter information into the **Backup Description** field.
2. Click **Create Backup** to create the backup.
3. Click **Download Backup**.

Upload and Restore Backup

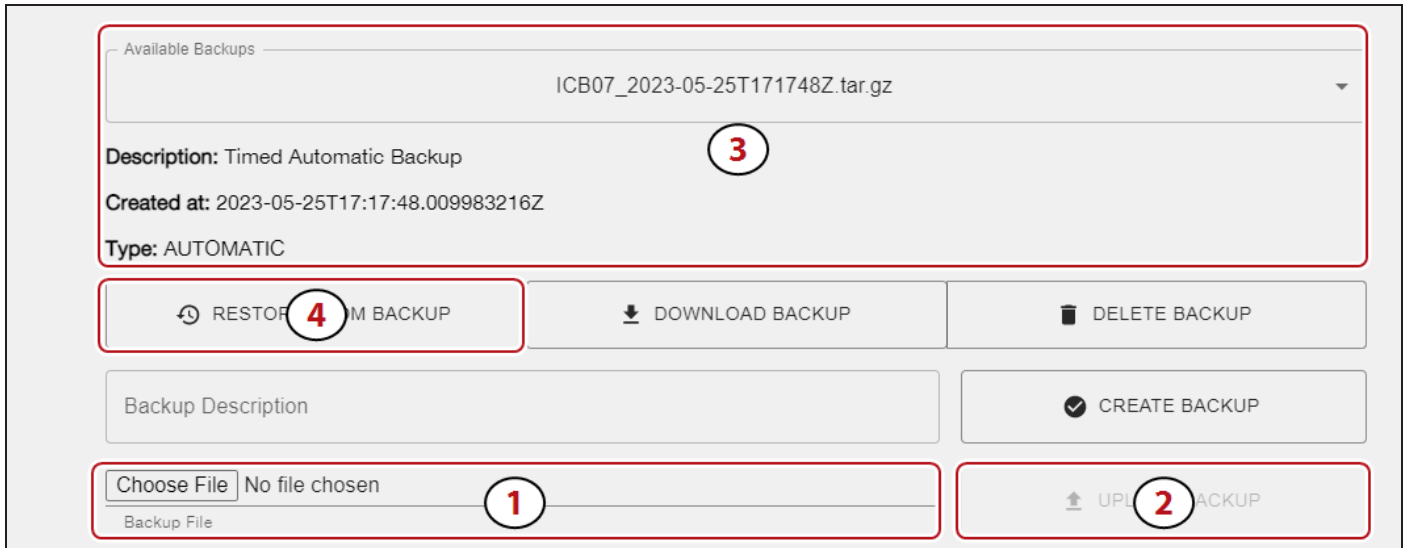

Figure 119 The LumOS Backup Restore screen.

Use the numbers in the figure above to help you with the following steps:

1. If necessary, click **Choose File** and select the desired file.
2. Click **Upload Backup** to upload the chosen file.
3. Using the **Available Backup** drop-down menu, select the desired backup.
4. Click **Restore From Backup**.

Note: You can also delete the selected backup by clicking **Delete Backup**.

PACKAGE UPDATE

This section describes updating the software package running on the library.

Note: After upgrading library software, you must clear your web browser cache if you use a web browser to access the library remotely.

Overview

This section describes updating the LumOS software using the LumOS user interface. Log into the LumOS user interface and select **Configuration > Package Update**.

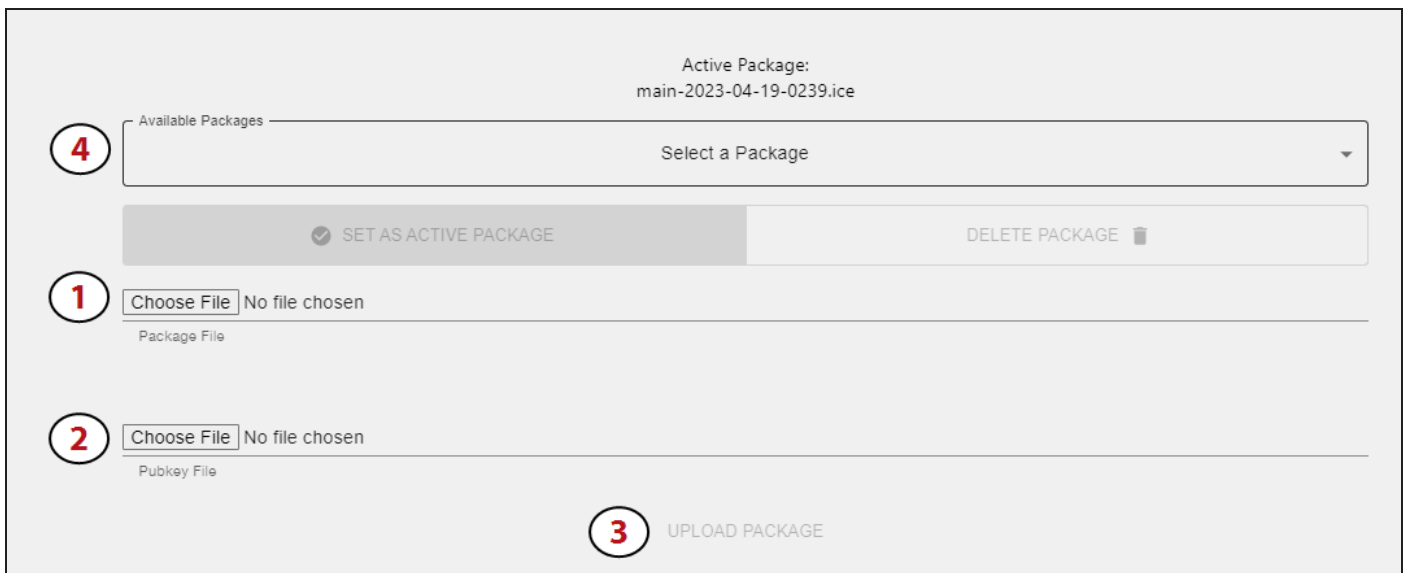

Figure 120 The LumOS Package Update screen.

Configuring a Package Update

The following section describes the steps to select and upload a package. Use [Figure 120](#) to help you complete the steps below.

1. Click **Choose File** and navigate to select your desired Package File. Click **Open**.
2. Click **Choose File** and navigate the file browser to select your desired Pubkey file. Click **Open**.
3. Click **Upload Package**. New packages display in the **Available Packages** drop-down menu.

Note: The **Available Packages** drop-down menu only contains packages that were previously uploaded.

4. Select a package from the **Available Packages** drop-down menu, then click **Set As Active Package** to update the library software.
5. After setting the active package, you may need to click **OK** on several pop-up screens (not pictured). The library then power cycles as part of the update process.

Note: After upgrading library software, you must clear your web browser cache if you use a web browser to access the library remotely.

DRIVE FIRMWARE UPDATE

Overview

Whenever you update your library software, confirm that your drives are using the latest firmware version. Drive firmware updates are occasionally require to resolve drive issues.

The method you use to update the drives depends on the type of drives you are updating and your operating environment. This guide covers using the LumOS user interface and IBM Tape Diagnostic Tool (ITDT) to update drive firmware.

Note: You must discontinue backup operations and empty the tape drives before you can update drive firmware.

Updating Drive Firmware in LumOS User Interface

This section describes upgrading drive firmware using the LumOS user interface which is the recommended method to update drive firmware. Log into the LumOS user interface and select **Configuration > Drive Firmware Update**.

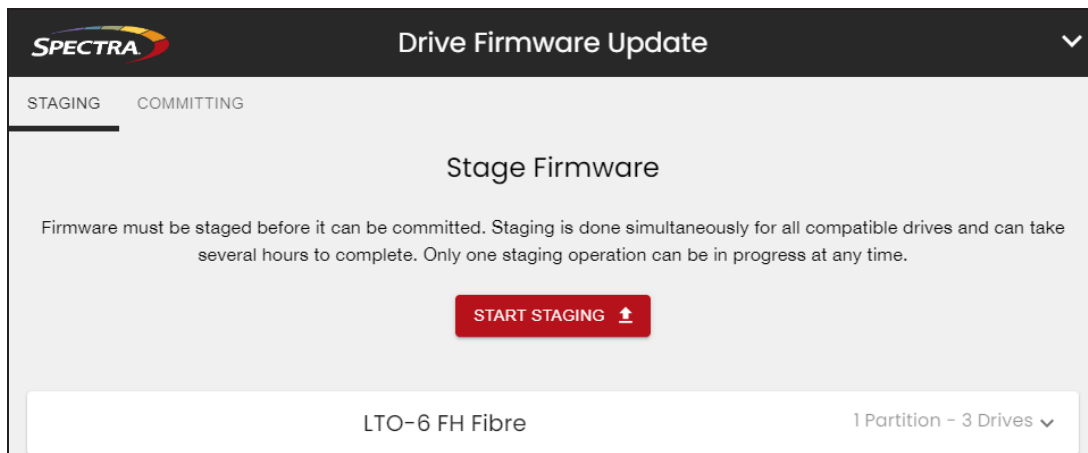

Figure 121 The LumOS Drive Firmware Update Staging screen.

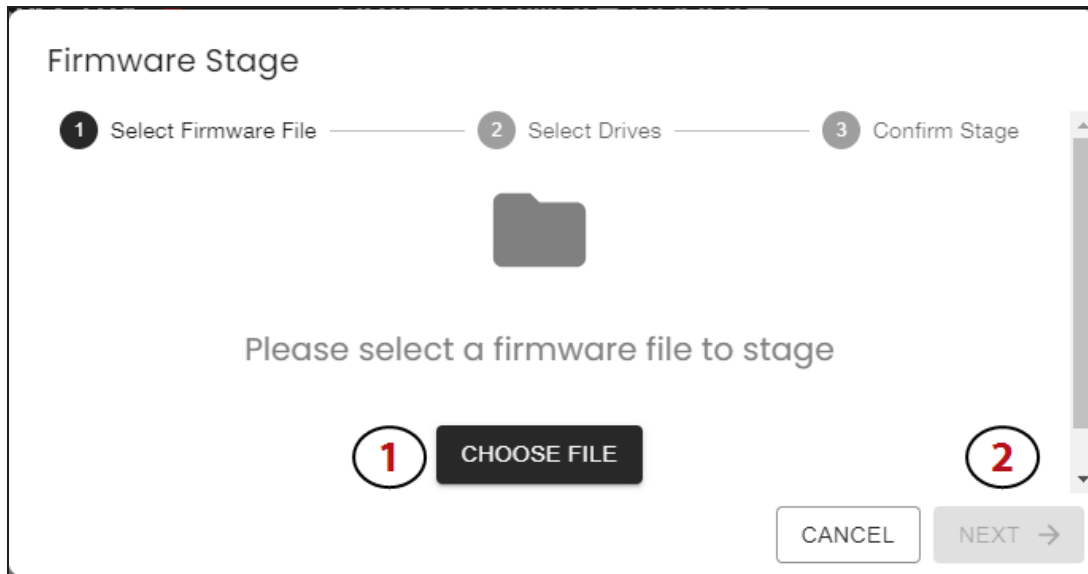

Figure 122 The LumOS Drive Firmware Stage Select Firmware File screen.

Click **Start Staging**, then use the steps below.

Note: Only one staging operation can be in progress at any time.

1. Click **Choose File** to open a file browser then select the desired firmware file.
2. Confirm the displayed firmware code and compatible drives information is correct and then click **Next**.

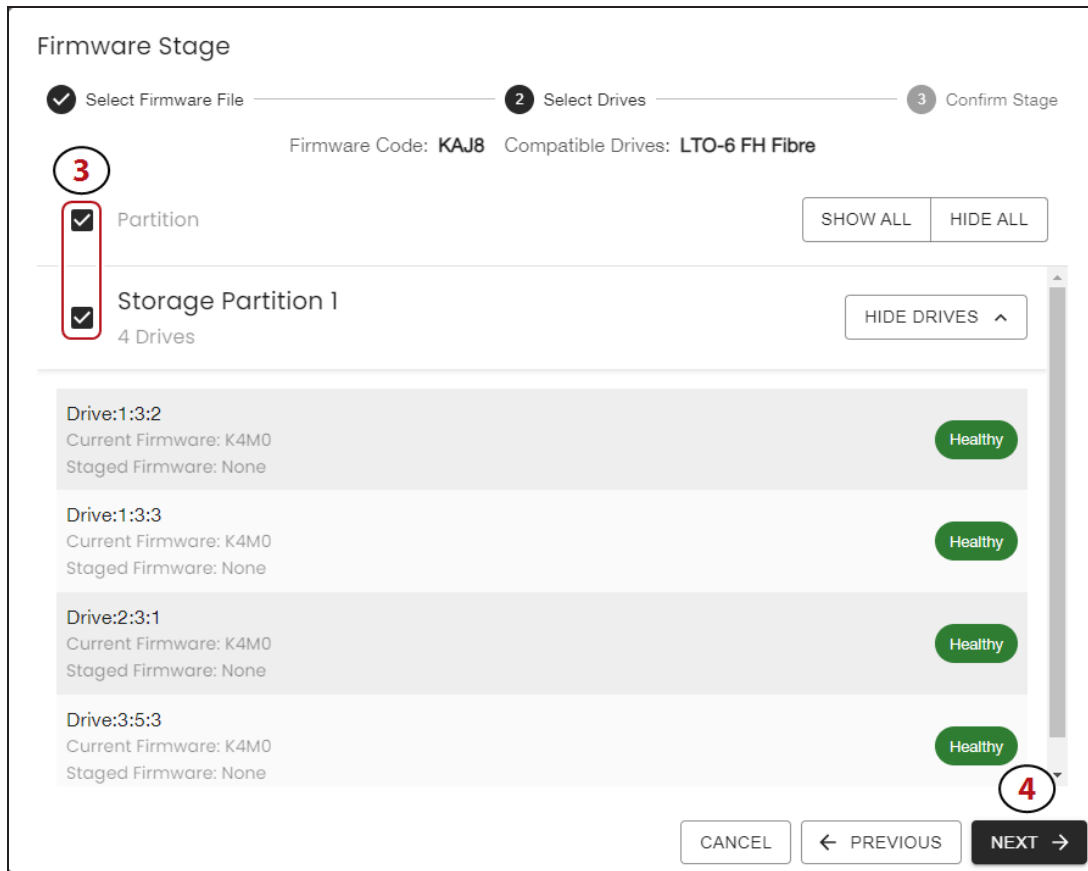

Figure 123 The LumOS Drive Firmware Stage Select Drives screen.

3. Select the partition to upgrade using the check box. To update all valid drives across all partitions, select the **Partition** check box.
4. Click **Next**.

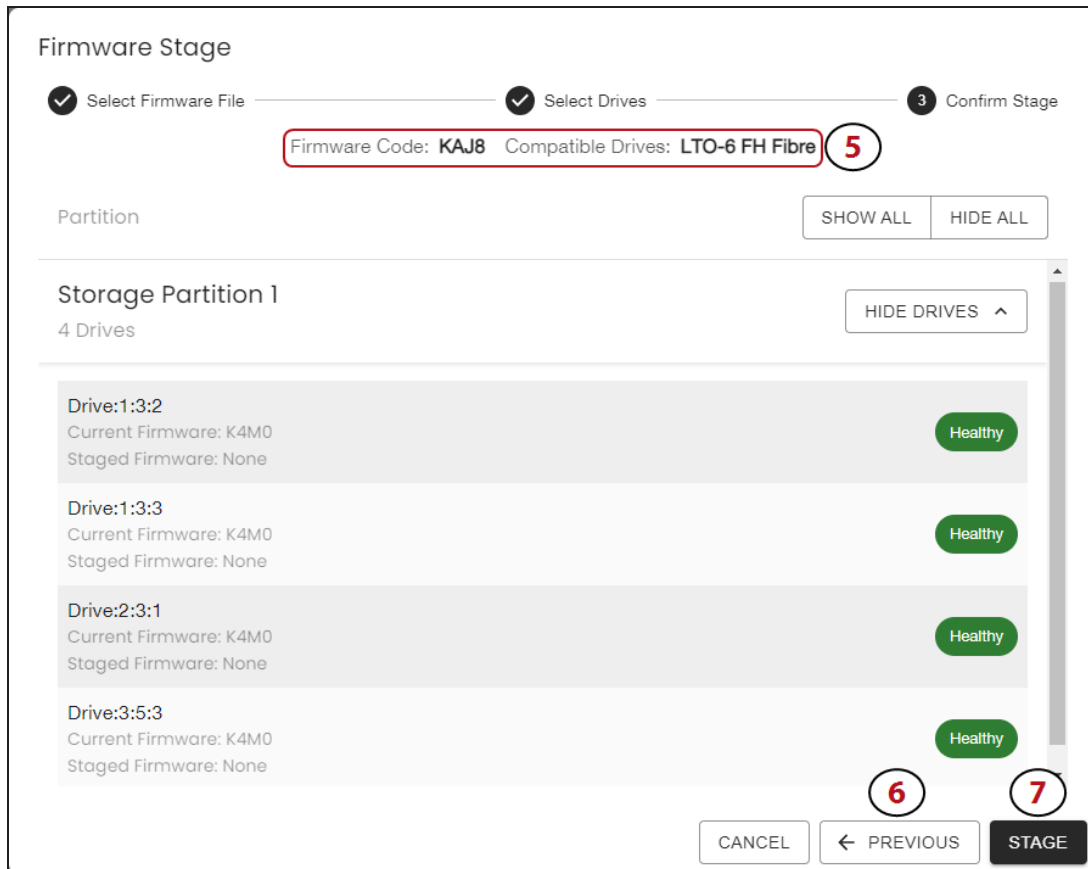

Figure 124 The LumOS Drive Firmware Stage Confirm Stage screen.

5. Confirm the **Firmware Code**, **Compatible Drives**, and selected drives are correct.
6. To make a correction, click **Previous** to return to previous pages.
7. Click **Stage**. The Staging screen displays the current operation progress and operation details.

Note: Staging may take several hours to complete. During the staging operation, you can continue normal backup operations.

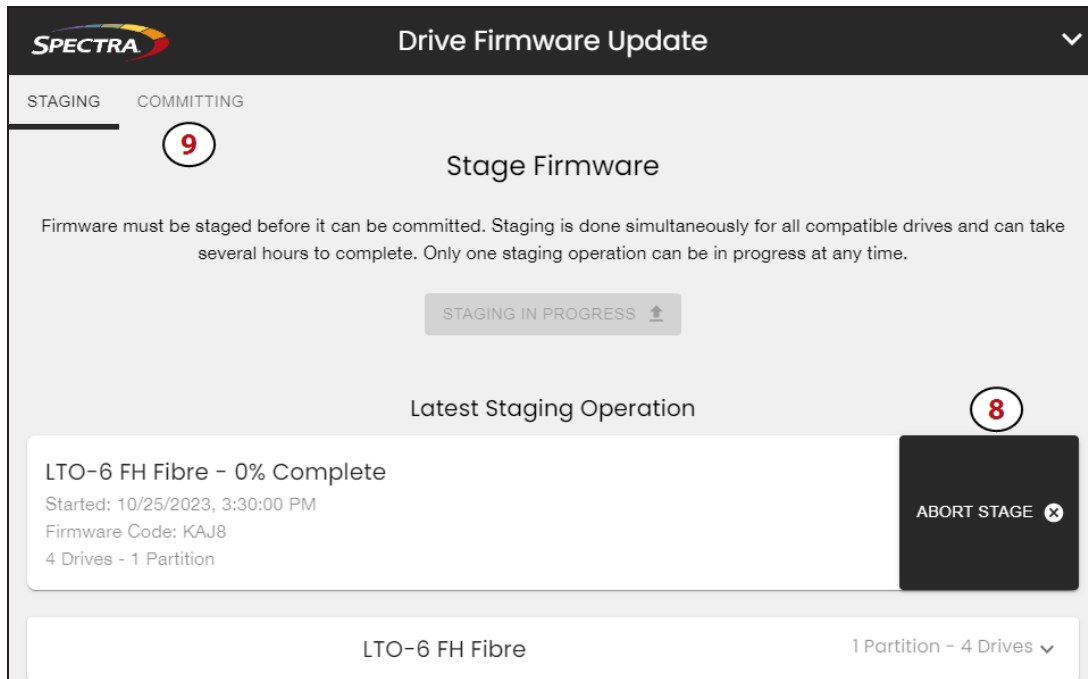

Figure 125 The LumOS Drive Firmware Update Staging screen.

8. If desired, click **Abort Stage** to cancel the operation.
9. After staging is complete, discontinue all backup operations and remove any cartridges from the drives.



CAUTION

Attempting to update the firmware while the library is busy or when the drives contain tapes may result in the update failing, failed backup jobs, or permanent damage to the drives. If you did not already do so, stop all backup operations and remove all tapes from the drives you are updating. If the library has SlotIQ enabled, run the Advanced Diagnostic **Unload Drives** followed by **Resolve SlotIQ**.

Once you have discontinued backups and emptied all drives, click **Committing** to view the Firmware Commit screen.

10. Select the desired **Drive Type** or **Partition**.

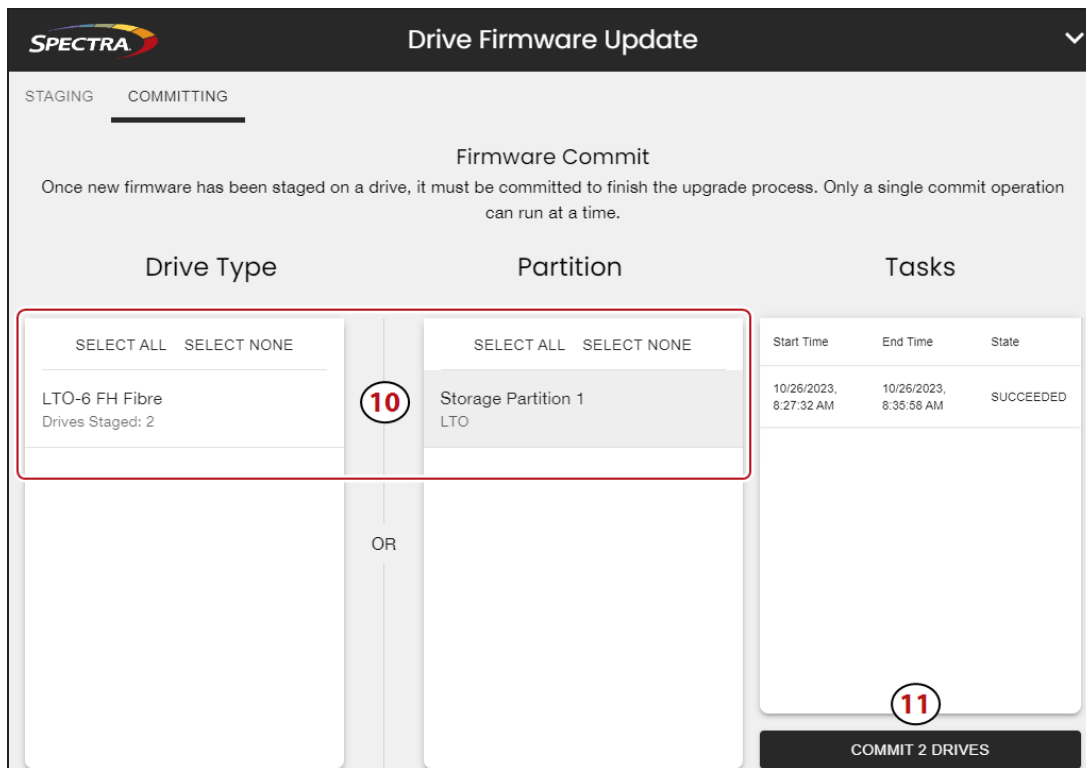

Figure 126 The LumOS Drive Firmware Update Firmware Commit screen.

11. Click **Commit Drives** to finish the upgrade process.

Note: Only a single commit operation can run at a time.

Updating Drive Firmware Using ITDT

Spectra Logic recommends using the LumOS interface to update drive firmware. If necessary, you can also update your LTO tape drive firmware with the IBM Tape Diagnostic Tool (ITDT).

Note: If your operating system is not supported by ITDT, or you cannot use ITDT in your environment, contact Spectra Logic Technical Support.

Download and Install ITDT

Download ITDT and its related documentation directly from IBM's Fix Central website.

Use the following steps to download and install ITDT on a computer that is connected to the same SAS or Fibre Channel arbitrated loop or fabric as the drives in the library.

1. Log into IBM's website (ibm.com/support/fixcentral), using your individual IBM ID.
2. Select the **Select product tab**.
3. Select the following options:
 - **Product Group** = System Storage
 - **Select from System Storage** = Tape systems
 - **Select from Tape Systems** = Tape drivers and software
 - **Select from Tape drivers and software** = IBM Tape Diagnostic Tool (ITDT)
 - **Platform** = Select your operation system from the drop-down list and click **Continue**.
4. On the next page, select the version of ITDT that you want to download. If desired, you can select multiple versions.

Note: If you are unsure which version to select, click **Show Fix Details** to see additional information.
5. Click Continue. If you have not logged into the website yet, it will prompt you to do so now.
6. Choose one of the following methods to download the selected ITDT installation files:
 - Download using your browser (HTTP)
 - Download using bulk FTP
 - Download using Download Director
7. Refer to the ITDT documentation for information about using ITDT. Contact Spectra Logic Technical Support if you need assistance (see [Technical Support on page 196](#)).

Download the Drive Firmware

1. After installing ITDT, launch the program so that it creates the **Input** and **Output** folders required during the firmware update process.
2. Log into your account on the Spectra Logic Technical Support portal at support.spectralogic.com.
3. Select **Downloads > Tape Drive Firmware**.
4. On the Tape Drive Firmware page, locate the appropriate drive firmware with respect to drive type (LTO), generation (for example, LTO-5), interface type (for example, SAS or Fibre Channel), and form factor (full-height or half-height).
5. Click the firmware version name in the column labeled **Current Firmware Version**.



IMPORTANT

The link in the column labeled **Package File (For Staging)** is for using Drive Firmware Update feature in the LumOS user interface. Do not select this file if you are updating drive firmware using ITDT.

6. Use your web browser to save the file to the ITDT **Input** folder on the computer where ITDT is installed.

Discontinue Background Operations

You cannot update drive firmware if the library is actively running any background operations, including Media Auto Discovery, PreScan, and PostScan.

If you do not want to wait for a Media Auto Discovery, PreScan, or PostScan operation to complete, you can stop the Media Auto Discovery or PreScan operation, or pause the PostScan operation. For other background operations, you must wait for the process to complete.

Discontinue Backups and Empty the Drives

Before beginning the drive firmware update process, discontinue all backup operations and remove any cartridges from the drives.



CAUTION

Attempting to update the firmware while the library is busy or when the drives contain tapes may result in the update failing, failed backup jobs, or permanent damage to the drives. If you did not already do so, stop all backup operations and remove all tapes from the drives you are updating. If the library has SlotIQ enabled, run the Advanced Diagnostic **Unload Drives** followed by **Resolve SlotIQ**.

1. If possible, use your storage management software to move any cartridges that are currently in drives back to their storage locations.
2. If you cannot use your storage management software, then move the cartridges as described in [Move Media on page 137](#).

Update Drives Using ITDT

1. Follow the instructions in the ITDT documentation to update the drive firmware.
2. Reset the updated drives to restore their configuration settings.
3. After the update is complete, use your storage management software to restart any backup processes.

ROBOTICS

The LumOS user interface allows you to monitor the health of the robots inside the T950 library. To view the status of the robots, log in to the library and navigate to **Status > Robotics**.

Robot Details

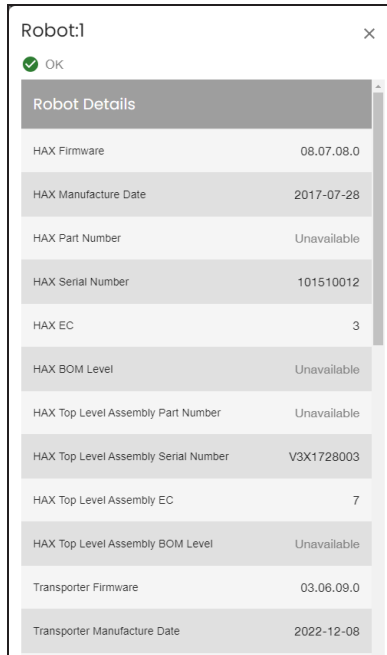

| Robot Details | |
|--------------------------------------|-------------|
| HAX Firmware | 08.07.08.0 |
| HAX Manufacture Date | 2017-07-28 |
| HAX Part Number | Unavailable |
| HAX Serial Number | 101510012 |
| HAX EC | 3 |
| HAX BOM Level | Unavailable |
| HAX Top Level Assembly Part Number | Unavailable |
| HAX Top Level Assembly Serial Number | V3X1728003 |
| HAX Top Level Assembly EC | 7 |
| HAX Top Level Assembly BOM Level | Unavailable |
| Transporter Firmware | 03.06.09.0 |
| Transporter Manufacture Date | 2022-12-08 |

Figure 127 The LumOS Robot Details screen

To view robot details, click **Details** under the robot desired. The **Robot Details** screen displays the following information for HAX, Transporter, and VAX components:

- Firmware version
- Manufacture Date
- Part Number
- Serial Number
- EC
- BOM Level
- Top Level Assembly Part Number
- Top Level Assembly Serial Number
- Top Level Assembly EC
- Top Level Assembly BOM Level

CHAPTER 8 - TECHNICAL SUPPORT

Spectra Logic Technical Support provides a worldwide service and maintenance structure, refined over many years to provide timely, professional service.



IMPORTANT

A valid LumOS software Support key is required in order to obtain technical support.

| | |
|---|------------|
| Accessing the Technical Support Portal | 197 |
| Create an Account | 197 |
| Log Into the Portal | 198 |
| Opening a Support Ticket | 199 |
| Search for Help Online | 199 |
| Submit an Incident Online | 202 |
| Submit an Incident by Phone | 204 |
| Returns | 205 |

ACCESSING THE TECHNICAL SUPPORT PORTAL

The Spectra Logic Technical Support portal provides access to the Knowledge Base, the current version of LumOS software for the library, drive firmware, drive device drivers, and additional service and support tools. You can also open or update a support incident and upload ASL files.

Create an Account

Access to *User Guides* and compatibility matrices does not require you to create an account. You must create a user account and log in to access *Release Notes* or repair documents, to download the latest version of LumOS software, or to open a support incident.

Note: If you have multiple Spectra Logic products, the serial numbers for all products will be associated with your account. If you do not see the serial numbers for all of your products when you log in, contact Technical Support (see [Contacting Spectra Logic on page 9](#)).

1. Access the Technical Support portal at support.spectralogic.com.
2. On the home page, click **Register Now**.

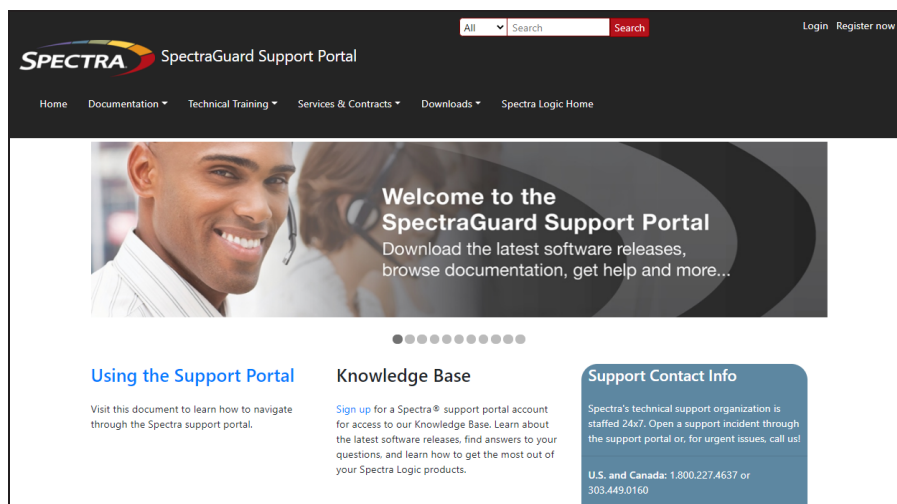
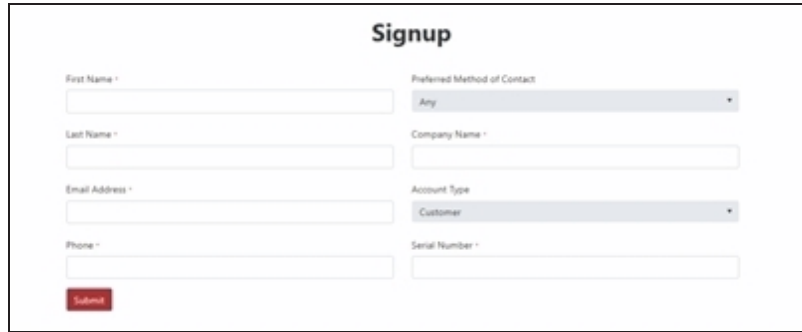

Figure 128 The Spectra Logic Technical Support portal home page.

3. Enter your registration information. Your account is automatically associated with the serial numbers of all Spectra Logic products owned by your site.

- If you have an invitation, follow the link and enter the invitation code.



The screenshot shows a 'Signup' form with the following fields and options:

- First Name - [text input]
- Last Name - [text input]
- Email Address - [text input]
- Phone - [text input]
- Preferred Method of Contact - [dropdown menu, selected 'Any']
- Company Name - [text input]
- Account Type - [dropdown menu, selected 'Customer']
- Serial Number - [text input]
- Submit - [red button]

Figure 129 The Sign-up screen.

- If you do not have an invitation, enter the requested information to create your account. When you are finished, click **Submit**.

When the account is approved, you receive an email with an initial password. Use your email address and the password provided in the email to log in to your account. After you log in, you can change your password if desired.

Log Into the Portal

Use your email address and password to log into the Technical Support Portal.

OPENING A SUPPORT TICKET

You can open a support incident using the Spectra Logic Technical Support portal or telephone.

Search for Help Online

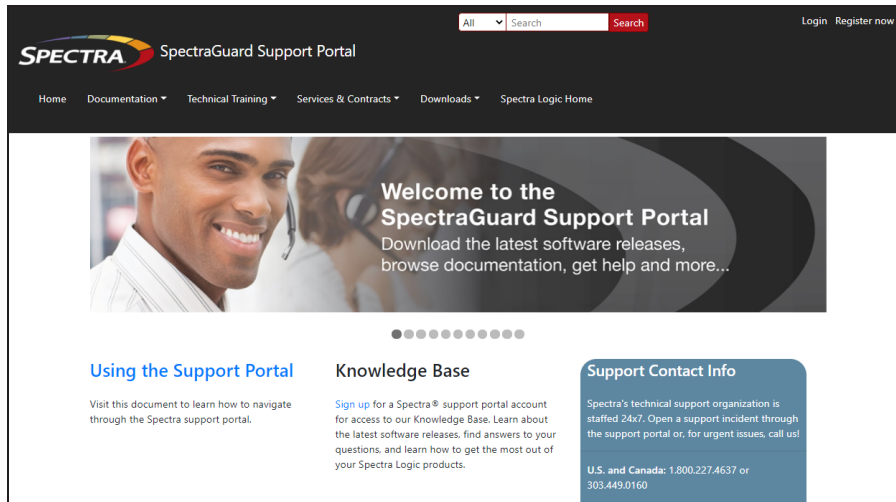

Figure 130 The Spectra Logic Technical Support portal home page.

1. Make notes about the problem, including what happened just before the problem occurred.
2. Gather the following information:
 - Your Spectra Logic customer number
 - Company name, contact name, phone number, and email address
 - The library serial number on the **Configuration>Settings** screen.
 - Type of host system being used
 - Type and version of host operating system being used
 - Type and version of host storage management software being used
3. If necessary, log in to the Support Portal by clicking **Login**, enter your **email address** and **password**, and click **Log in**.

Note: See [Accessing the Technical Support Portal](#) on page 197 if you have not previously created an account on the Technical Support portal.

4. From any page, select **Incident>Incidents & Inventory**.

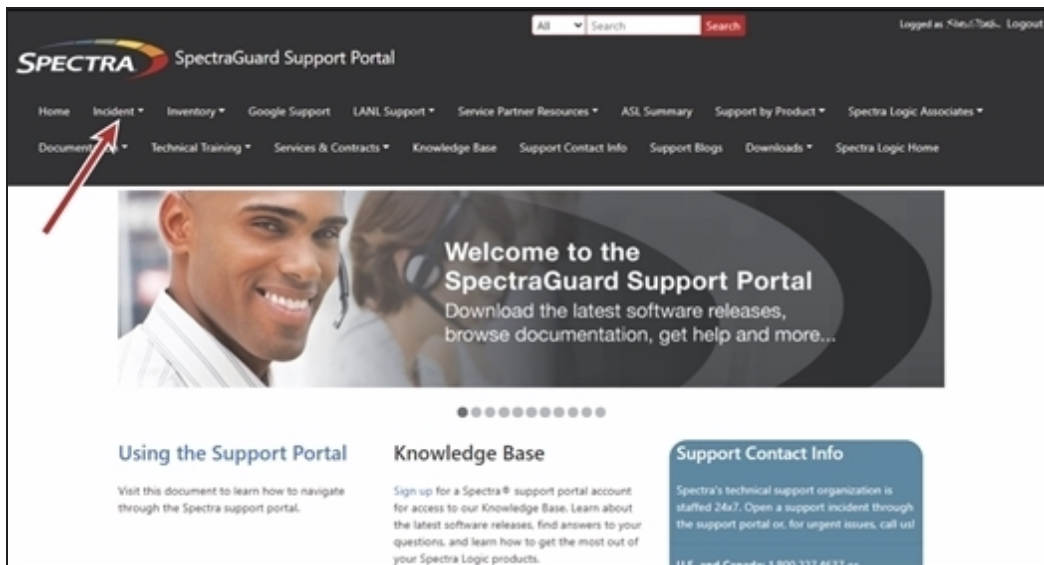

Figure 131 Select **Incidents>Incidents & Inventory**.

5. Select **Open or View Incidents**.

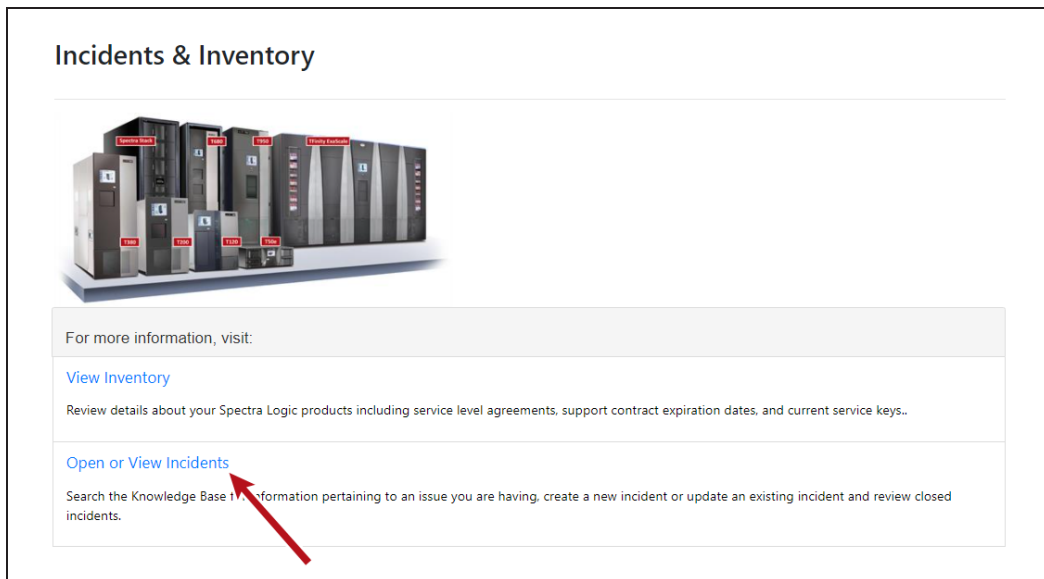

Figure 132 Select **Open or View Incidents**.

6. In the Search dialog box, enter a term or phrase about your problem (1) and click **Search** (2).

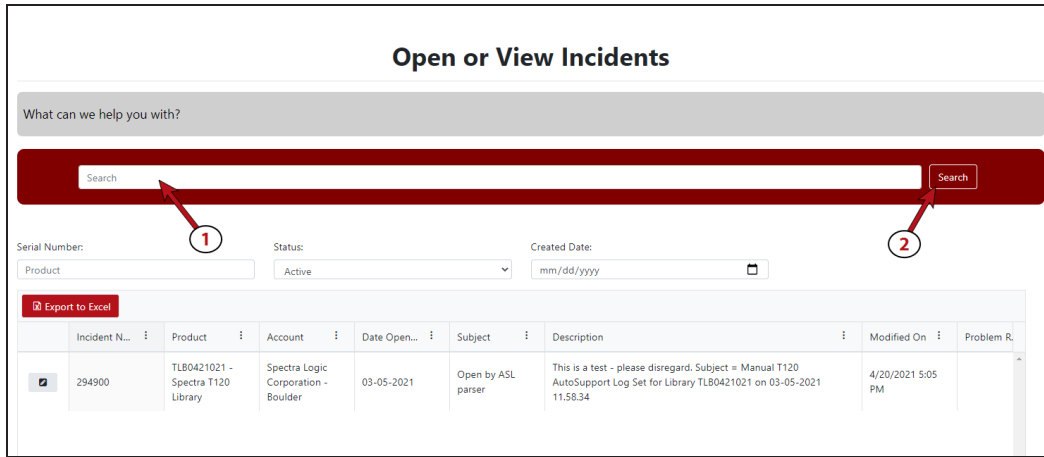

Figure 133 Enter a search phrase and click **Search**.

7. If the search does not provide an answer, click **Open a New Incident**.

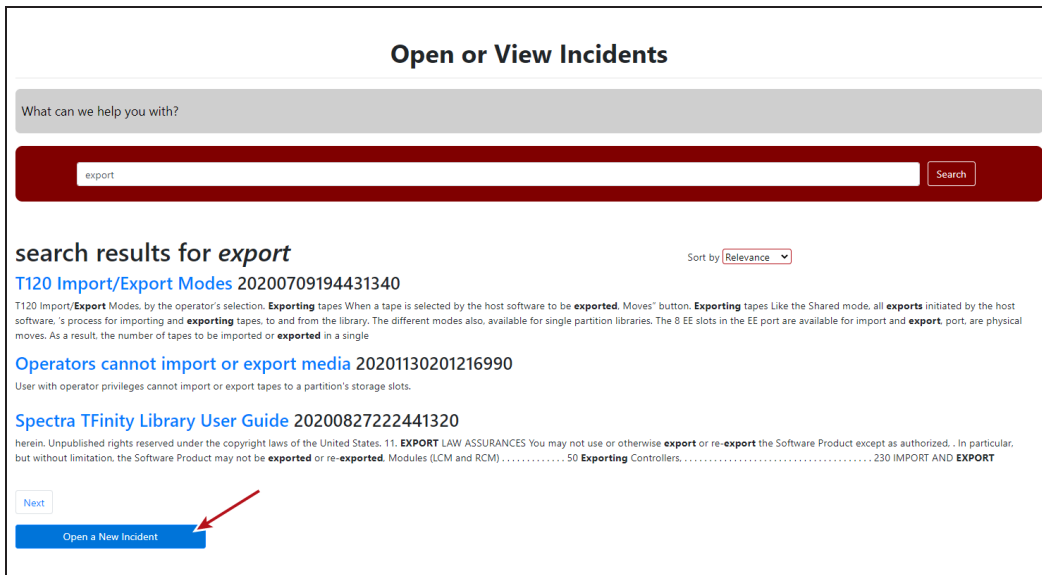

Figure 134 Click **Open a New Incident**.

8. On the Create Incident page, enter the requested information providing as much detail as possible. When you are finished, click **Submit**.

Create Incident

Severity *

Problem Description *

Email addresses to include in correspondence

Customer *

Product *

Select files...

DELIVERY Address For Shipping Parts

Confirm The Ship To Address

Submit

Figure 135 Enter information about your incident and click **Submit**.

Submit an Incident Online

1. Make notes about the problem, including what happened just before the problem occurred.
2. Gather the following information:
 - Your Spectra Logic customer number
 - Company name, contact name, phone number, and email address
 - The library serial number on the **Configuration>Settings** screen.
 - Type of host system being used
 - Type and version of host operating system being used
 - Type and version of host storage management software being used
3. If necessary, log in to the Support Portal by clicking **Login**, enter your **email address** and **password**, and click **Log in**.

Note: See [Accessing the Technical Support Portal](#) on page 197 if you have not previously created an account on the Technical Support portal.

4. From any page, select **Inventory>My Inventory**.

5. Locate the row of the product for which you want to submit an incident and click **Create Incident**.

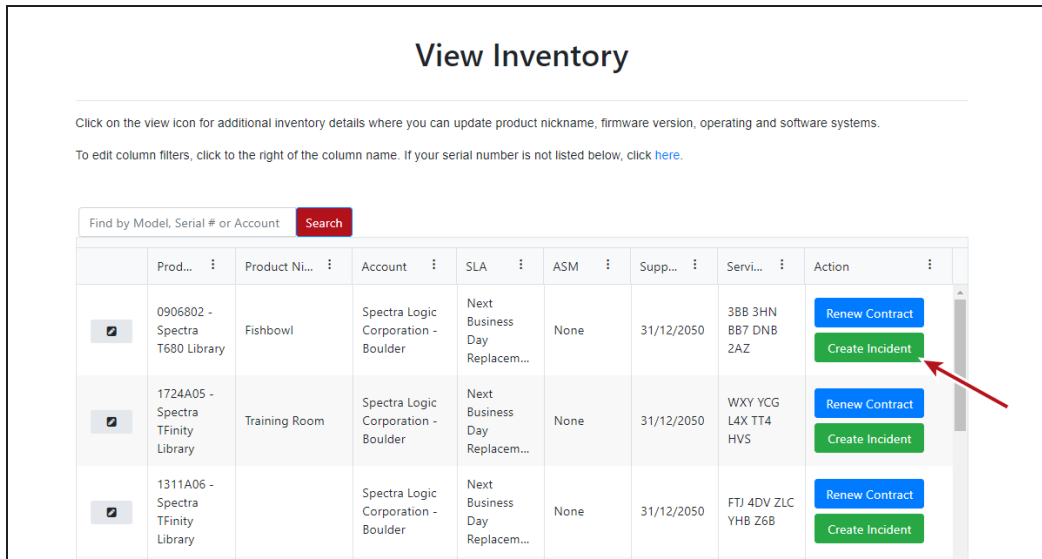

Figure 136 Click **Create Incident**.

6. On the Create Incident page, enter the requested information providing as much detail as possible. When you are finished, click **Submit**.

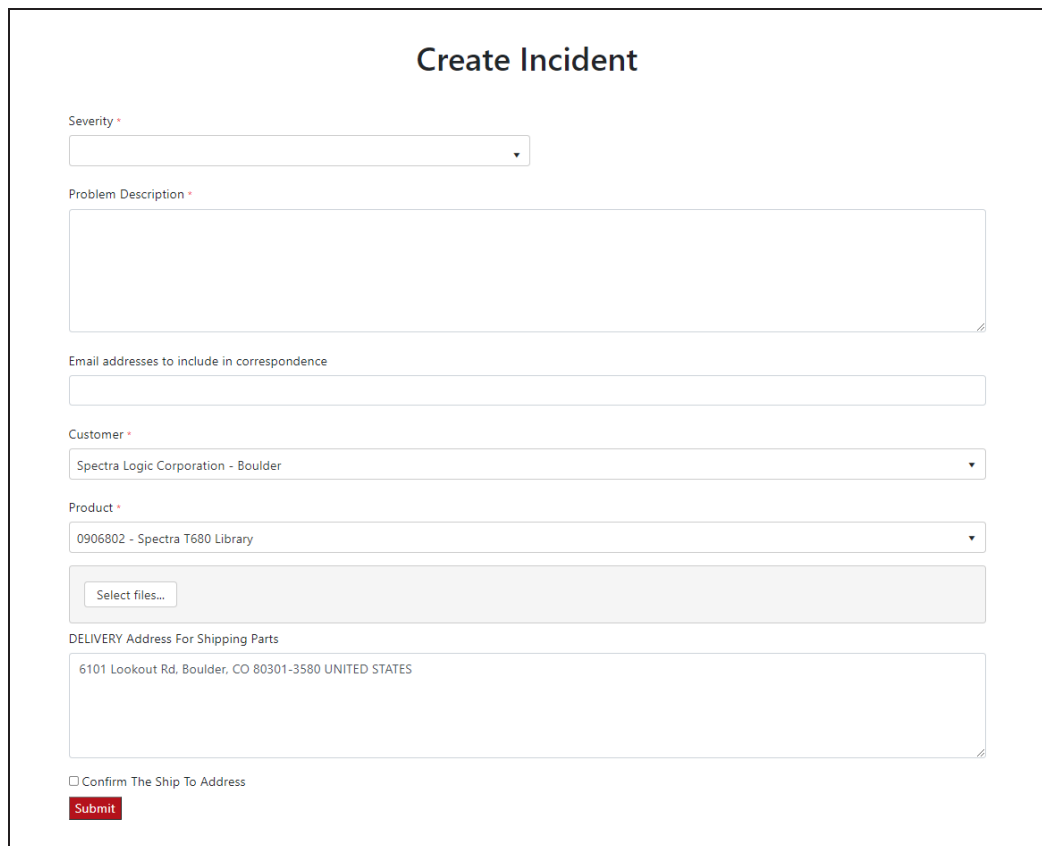

Figure 137 Enter information about your incident and click **Submit**.

Submit an Incident by Phone

Contact Spectra Logic Technical Support by phone using the information below.

| Spectra Logic Technical Support | |
|---|--|
| Technical Support Portal: support.spectralogic.com | |
| United States and Canada Phone: Toll free US and Canada: 1.800.227.4637 International: 1.303.449.0160 | Europe, Middle East, Africa Phone: 44 (0) 870.112.2185 Deutsch Sprechende Kunden Phone: 49 (0) 6028.9796.507 Email: spectralogic@stortrec.de |
| Mexico, Central and South America, Asia, Australia, and New Zealand Phone: 1.303.449.0160 | |

RETURNS

Your Technical Support representative may ask you to return a problem component to Spectra Logic for analysis and servicing. After you complete a replacement procedure, return the defective part using ALL of the packaging that the replacement part arrived in (including any anti-static bags or foam inserts).

**CAUTION**

Severe damage can occur if the component is not packaged correctly. You may be invoiced if it is damaged due to improper or insufficient packaging.

Use the return label and instructions that were included with the replacement part when preparing to ship the component you are returning. If you cannot locate these, contact Spectra Logic for another copy (see [Contacting Spectra Logic on page 9](#)). The return label and Return Merchandise Authorization (RMA) printed on it are used to associate the returned component with your account. To avoid being invoiced for failure to return the component, do not ship the component back to Spectra Logic without the RMA return label.

APPENDIX A - BEST PRACTICES

This appendix reviews best practices for using Media Lifecycle Management, protecting library configuration data, and working with media.

| | |
|---------------------------------------|------------|
| MLM Best Practices | 207 |
| Implementation Guidelines | 207 |
| Usage Policy Guidelines | 208 |
| Using Cartridges | 209 |
| Labeling Cartridges | 209 |
| Handling Cartridges | 210 |
| Storing Cartridges | 211 |
| Using Cartridges in the Library | 212 |
| Cartridge Rotation | 213 |

MLM BEST PRACTICES

To effectively use MLM and ensure MLM and DLM data protection, plan a strategy based on your data center needs and develop policies and procedures to support that strategy. Having sound management policies and procedures for media rotation and management is essential for consistent, effective implementation.

Implementation Guidelines

Consider the following best practice guidelines as you prepare to implement MLM in your environment.

| Guideline | Description |
|--|--|
| Identify the people responsible for backing up data | The people who perform data backup at your site are typically the ones who will be responsible for implementing and following MLM backup procedures. |
| Identify the users who will have responsibilities that involve MLM | It may be wise to have more than a single user familiar with policies, depending on the size of your organization, so that if one person is not available, another can take over. |
| Be consistent with partition names | Using consistent naming simplifies identifying a specific partition. Spectra's suggested naming practice is to list the location, followed by the library name, followed by the storage management software. For example, Dallas T950 library NetBackup. |
| On an organizational level, determine the level of management your media requires | The level of media management depends on the requirements for your environment. For example, you may choose to use Spectra's guidelines for retirement for all media, or you may choose to retire tapes that hold financial or legal data sooner than recommended. |

Usage Policy Guidelines

Consider the following guidelines when establishing your Media Lifecycle Management policies.

| Guideline | Description |
|--|---|
| <p>Choose a retirement guideline</p> | <p>When implementing MLM, decide at the beginning on the criteria to be used when determining when to retire a cartridge.</p> <p>Spectra suggests using the Media Lifecycle Management health icon for each tape to assess the overall health of individual tapes.</p> |
| <p>Only use MLM-enabled media and cleaning cartridges in MLM-compatible libraries and drives</p> | <p>For the most accurate tracking, do not import your MLM-enabled media into non-Spectra Logic libraries or drive generations earlier than LTO-4. The cartridge MAM will not be updated with information about usage in those locations. As a result, the information about usage in those locations will not be recorded in the MLM database when the cartridge is returned to your library.</p> |
| <p>Use only Spectra Certified Media with MLM support (both data and cleaning cartridges) in the library</p> | <p>To ensure the best possible performance, use Spectra Certified Media. Check the Spectra Logic website for the most up-to-date media availability. Do not use any media that has not been approved by Spectra Logic for use in the library.</p> <p>The library uses information in the MLM database to monitor the health of the media in the library. For MLM-enabled media, the detailed health reports let you determine whether a particular data cartridge is past its useful threshold or determine whether a particular cartridge is experiencing high errors rates or retries. For MLM-enabled cleaning cartridges, you are notified when a cartridge is approaching the end of its useful life.</p> <p>Although MLM tracks the general health of media that is not MLM-enabled, detailed health information is not available for this media.</p> |

USING CARTRIDGES

The following sections describe best practices for using cartridges and for managing your media inventory. All library user groups have privileges that allow them to use the library's user interface to perform the cartridge handling and media management operations described in this appendix. Because handling cartridges requires physical interaction with the library, much of the information in this appendix is not applicable when you are accessing the library using the LumOS web interface.

Note: See *MLM Best Practices* on page 207 for additional guidance when using Spectra Certified Media with MLM support.

Labeling Cartridges

If you are not using pre-labeled Spectra Certified Media (both data and cleaning cartridges), be sure to label all cartridges with the appropriate barcode labels. Position each label in the indented area on the cartridge, as illustrated in [Figure 138](#). See [Barcode Label Specifications](#) for detailed information about preparing and using barcode labels.

**CAUTION**

Do not place labels on any surface of the cartridge except the area shown in [Figure 138](#). A loose label can become dislodged and damage the drive.

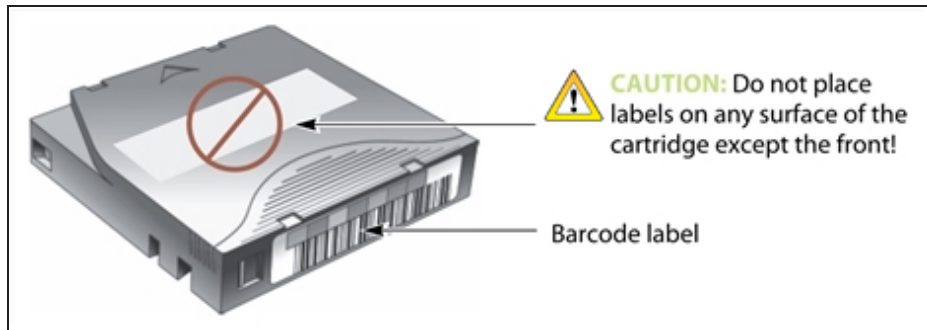

Figure 138 Properly barcode label all cartridges (LTO cartridge shown).

Handling Cartridges

Incorrect handling or an incorrect environment can damage the LTO cartridge or the magnetic tape inside it. To avoid damage to your cartridges and to ensure the continued high reliability of your drives, use the following guidelines:

- Do not drop the cartridge. If the cartridge drops, slide the cartridge door back and ensure that the leader pin is properly seated in the pin-retaining spring clips. Inspect the rear of the cartridge (the part that you load into the tape drive first) and ensure that there are no gaps in the seam of the cartridge case.
- Do not open any part of the cartridge other than the cartridge door. Do not open any other part of the cartridge case. The upper and lower parts of the case are held together with screws; separating them destroys the usefulness of the cartridge.
- Do not handle tape that is outside of the cartridge. Handling the tape can damage the tape's surface or edges, which may interfere with read or write reliability. Pulling on tape that is outside of the cartridge can damage the tape and the brake mechanism in the cartridge.
- If tape is outside of the cartridge, slide the cartridge door back and turn the hub to gently spool the tape back into the cartridge. Test the tape by using your storage management software to write to the tape, and then run a PostScan.
- Before you use a cartridge, let it acclimate for at least 24 hours to the normal operating environment.
- Ensure that all surfaces of a cartridge are dry before inserting it into a magazine.
- Do not stack more than six cartridges.
- Do not expose the tape cartridge to moisture or direct sunlight.
- Do not degauss a tape cartridge that you intend to use/reuse. Degaussing makes the tape unusable.
- Do not expose recorded or blank tape cartridges to stray magnetic fields (such as terminals, motors, video equipment, X-ray equipment, or high-current cables or power supplies). Such exposure can cause the loss of recorded data or make the blank cartridge unusable.
- Maintain the environmental conditions specified in [Tape Media Specifications](#).

Storing Cartridges

While in use, cartridges are stored in TeraPack magazines inside the library. When the cartridges are *outside* of the library, Spectra Logic recommends storing them in magazines with dust covers.



Figure 139 TeraPack magazines with barcode labeled cartridges and plastic dust cover (LTO magazines shown).

Storing and handling cartridges in magazines helps to eliminate errors resulting from mishandling individual cartridges, which is the leading cause of cartridge damage. An optional clear plastic dust cover snaps onto the magazine to protect the cartridges.

Whenever you remove cartridges from your library, be sure to store them properly to maximize archival life and ensure data integrity. Follow these guidelines for proper cartridge storage:

- Store cartridges in a suitable environment (see [Tape Media Specifications](#)).
- Keep the storage location as free of airborne particulates as possible. To eliminate obvious sources of particulates, do not permit anyone to smoke, eat, or drink near the storage area, and do not store cartridges near a copier or printer that may emit toner and paper dust.
- Store cartridges with the write-protect switch in the protected position (see [Preparing Cartridges for Use](#)).
- Store cartridges as soon as possible after you remove them from the library. Immediate storage helps avoid many of the conditions that can damage tapes, such as temperature and humidity fluctuations, particulate contamination, and excessive handling.
- If you plan to ship a TeraPack magazine, make sure that you have a proper shipping container and that you use adequate packing material. The TeraPack carrying cases available from Spectra Logic are designed for safely transporting TeraPack magazines off site and are compatible with Iron Mountain.

Using Cartridges in the Library

This section describes the best practices for using cartridges in the library.

- Use only cartridges from approved vendors in the library. See [Media and Media Accessories](#) for more information about Spectra Certified Media.
- Make sure that the entry/exit pool contains one or more empty TeraPack magazines. This is particularly important when your storage management software ejects tape cartridges from a partition.

If the entry/exit pool does not have any empty slots available for the ejected media, then the storage management software must wait until empty slots become available. The simplest way to avoid this delay is to import one or more empty TeraPack magazines after you export media from the library.

Alternatively, always make sure that you import full TeraPack magazines into the library, then use your storage management software to move (import) all of the new media into the storage pool for the partition. After all of the media is moved to the storage pool, you will end up with one or more empty magazines in the entry/exit pool.

- Make the entry/exit pool large enough to accommodate all of the cartridges typically imported or exported during a single operation. For example, if you run a nightly backup that uses 48 cartridges which are then exported each morning, create an entry/exit pool of 50 LTO slots (5 chambers).
- After your library has been in use for a period of time, and at least one set of cartridges has completed a round trip (exported from the library, stored off site, then re-imported), the following rule of thumb applies: if you remove a TeraPack magazine from the entry/exit pool, replace it with either an empty magazine to accommodate future eject operations or a full magazine whose cartridges are then imported into the storage pool using your storage management software.
- During an import or export operation, do not leave the library unattended for more than a few minutes. If you do, the import or export operation times out so that the library can continue automated backup tasks. To continue, restart the operation when you are ready.
- Enable Auto Drive Clean and configure a cleaning partition to clean drives whenever required to help ensure optimal performance. If you do not use the Auto Drive Clean feature, periodically check the Drives screen to determine whether the drives require cleaning (see [Cleaning a Drive](#)).
- Confirm the quality of your media and verify data integrity by occasionally running restores using different drives.
- Confirm the quality of both media and drives by running periodic disaster recovery drills. These drills test the overall ability to recover all of your data using your backups.

Cartridge Rotation

During normal backup operations, tapes are rotated into and out of the library. This section provides a simple example of the library's media life cycle functionality to manage tape rotation. Using a backup plan similar to the one described in the following example for a period of time establishes a media rotation schedule for the library. The example assumes the following:

- The library has a total of 17 licensed chambers and uses LTO media.
 - 2 chambers are assigned to the entry/exit pool (20 slots, or 2 TeraPack magazines).
 - 15 chambers are assigned to the storage pool (150 slots, or 15 TeraPack magazines).
- The library contains 15 full TeraPack magazines and two empty TeraPack magazines.
- Two magazines containing 20 cartridges worth of backup data are sent off site every Friday.
- After the data has aged two weeks, the media is returned to the library and re-used.
- The site adheres to the following best practices:
 - Whenever a TeraPack magazine is exported, another magazine (either full or empty) is imported.
 - The library has enough empty TeraPack magazines to fill the entry/exit pool.

This example shows that, by Week 3, the backup plan results in a full media rotation in which the operator has done the following:



1. Removed and stored two full TeraPack magazines of media. Full magazines were exported from the entry/exit pool and removed through the TAP, resulting in an empty entry/exit pool.
2. Imported two full TeraPack magazines into the entry/exit pool through the TAP and then used the storage management software to move the media in the entry/exit pool into the storage pool.

Moving the media to the storage pool leaves two empty magazines in the entry/exit pools, ready to accept media as the storage management software identifies media as ready to be ejected from the library.

The following sections describe and illustrate the rotation process .



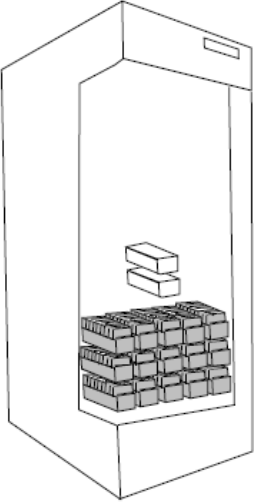

Initial Installation of Cartridges

The library is configured with a single partition and has a total of 17 licensed chambers assigned to either the entry/exit pool or storage pool. When the library is initially installed, chambers are filled with TeraPack magazines as described in the following illustration.

| | |
|--|--|
| <p>Library:</p> <ul style="list-style-type: none"> ▪ Entry/Exit pool: 2 chambers contain empty TeraPack magazines. ▪ Storage pool: 15 chambers contain full TeraPack magazines.  | <p>Data center: 4 empty TeraPack magazines available.</p>  |
|--|--|

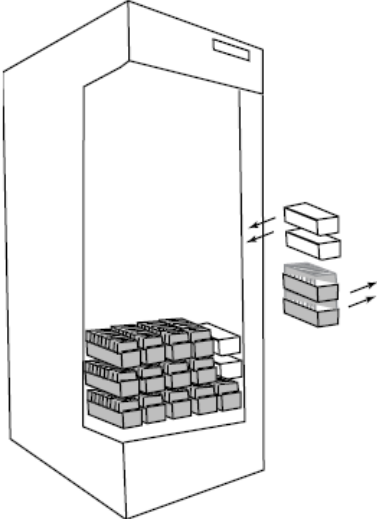

End of Week 1

The storage management software ejects cartridges from the storage pool. The library moves the cartridges to empty magazine slots in the entry/exit pool, making them ready to be removed from the library and stored off site.

| | |
|---|--|
| <p>Operator tasks:</p> <ul style="list-style-type: none"> ▪ Export 2 full TeraPack magazines from the entry/exit pool. ▪ Import 2 empty TeraPack magazines into the entry/exit pool.  | <p>Results of operator tasks:</p> <p>Off-site storage: 2 full TeraPack magazines.</p>  <p>Entry/Exit pool: 2 chambers, each contains an empty TeraPack magazine.</p>  <p>Storage pool:</p> <ul style="list-style-type: none"> ▪ 13 chambers contain full TeraPack magazines. ▪ 2 chambers contain empty TeraPack magazines.  <p>Data Center: 2 empty TeraPack magazines.</p>  |
|---|--|

End of Week 2

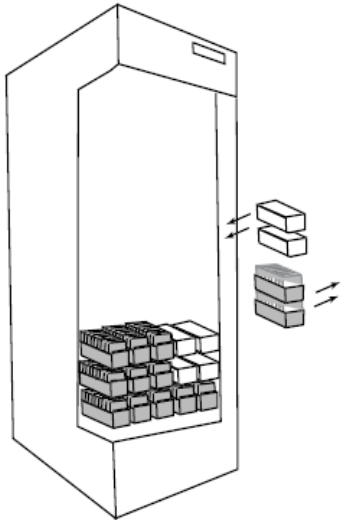
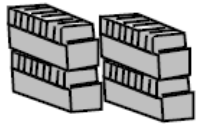
The storage management software ejects cartridges from the storage pool. The library moves the cartridges to empty magazine slots in the entry/exit pool, making them ready to be removed from the library and stored off site.

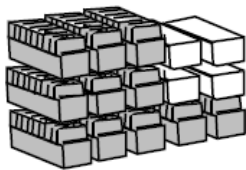
| | |
|---|---|
| <p>Operator tasks:</p> <ul style="list-style-type: none"> ▪ Export the 2 full TeraPack magazines from the entry/exit pool. ▪ Import 2 empty TeraPack magazines into the entry/exit pool.  | <p>Results of operator tasks:</p> <p>Off-site storage: 4 full TeraPack magazines</p>  <p>Entry/Exit pool: 2 chambers, each contains an empty TeraPack magazine.</p>  <ul style="list-style-type: none"> ▪ Storage pool: 11 chambers contain full magazines ▪ 4 chambers contain empty TeraPack magazines. <p>Data Center: No reserved media or magazines.</p>  |
|---|---|

End of Week 3

The storage management software ejects cartridges from the storage pool. The library moves the cartridges to empty magazine slots in the entry/exit pool, making them ready to be removed from the library and stored off site. The two full magazines stored off site in Week 1 are ready for re-use. After importing the full magazines into the entry/exit pool, the storage management software is used to move the cartridges to the storage pool, leaving two empty magazines in the entry/exit pool.

Operator tasks:

- Export the 2 full TeraPack magazines from the entry/exit pool.
- Import 2 full TeraPack magazines into the entry/exit pool.
- Use storage management software to move cartridges to the storage pool.

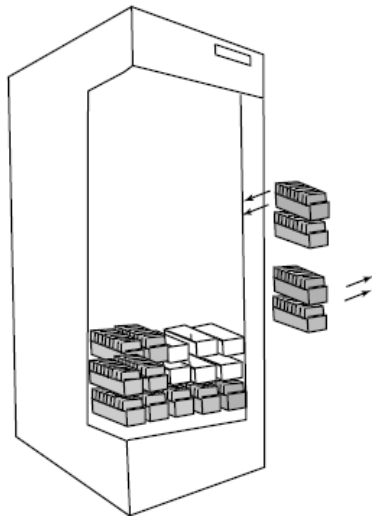

Results of operator tasks:

Off-site storage:

4 full TeraPack magazines

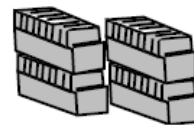

Entry/Exit pool:

2 chambers, each contains an empty TeraPack magazine.



▪ **Storage pool:**

11 chambers contain full magazines

- 4 chambers contain empty magazines



Data Center: No reserved media or magazines.

APPENDIX B - SPECIFICATIONS

This appendix provides specifications for the Spectra T950 library, as well as the drives and media used in the library:

| | |
|--|------------|
| Library Specifications | 218 |
| Data Storage Capacity | 218 |
| Size and Weight | 221 |
| Service Access Requirements | 223 |
| Shipping and Storage Size and Weight | 223 |
| Power Specifications | 224 |
| Environmental Specifications | 229 |
| Shock and Vibration Specifications | 231 |
| Interface Specifications | 232 |
| Component Interface Connectors | 232 |
| Network Interface Cable Requirements | 232 |
| Universal Serial Bus (USB) Support | 234 |
| NDMP Support | 234 |
| Tape Drive and Media Specifications | 235 |
| LTO Tape Drive Specifications | 235 |
| TS11xx Technology Tape Drive Specifications | 239 |
| Drive-Based Encryption Highlights | 242 |
| Tape Media Specifications | 242 |
| Barcode Label Specifications | 246 |
| Interoperability and Software Compatibility | 251 |

Note: The specifications in this chapter are subject to change without notice.

LIBRARY SPECIFICATIONS

The following sections provide detailed specifications for the library including data storage capacity, library size and weight, space requirements, power specifications, environmental specifications, and shock and vibration specifications.

Data Storage Capacity

The T950 library provides flexible storage capacity that expands from a minimum of one storage chamber up to the maximum storage capacity of the library. The capacity specifications in this section assume that only one type of drive and media is installed in the frame. When using mixed drives and media, the library's capacity depends on the number of frames in the library, the number of drives and slots inside each frame, and the type(s) of drives and media used. See [Drive, Media, and Service Frames](#) for an explanation of the different types of frames used in the library.

T950 Main Frame

The following table shows the capacity of the T950 library's main frame in its two basic configurations.

| Frame Type T950 Main - LTO | Tape Drives | Number of Chambers (Slots) | Native Capacity (TB) | | | | | |
|----------------------------|-------------|----------------------------|----------------------|-------|-------|--------|-------|-------|
| | | | LTO-5 | LTO-6 | LTO-7 | Type M | LTO-8 | LTO-9 |
| 3 DBAs/3 TBAs | 12 | 95 (950) | 1425 | 2375 | 5700 | 8550 | 11400 | 17100 |
| 6 DBAs | 24 | 83 (830) | 1245 | 2075 | 4980 | 7470 | 9960 | 14940 |

T950B Main Frame

The following table shows the capacity of the T950 liBbrary's main frame in its two basic configurations.

| Frame Type T950B Main - LTO | Tape Drives | Number of Chambers (Slots) | Native Capacity (TB) | | | | | |
|-----------------------------|-------------|----------------------------|----------------------|-------|-------|--------|-------|-------|
| | | | LTO-5 | LTO-6 | LTO-7 | Type M | LTO-8 | LTO-9 |
| 1 DBAs/shelves | 4 | 100 (1000) | 1500 | 2500 | 6000 | 9000 | 12000 | 18000 |

| Frame Type T950B Main - LTO | Tape Drives | Number of Chambers (Slots) | Native Capacity (TB) | | | | | |
|--------------------------------------|----------------|----------------------------------|----------------------|-------|-------|--------|-------|-------|
| | | | LTO-5 | LTO-6 | LTO-7 | Type M | LTO-8 | LTO-9 |
| 3 DBAs/3 TBAs or shelves | 12 | 92 (920) | 1380 | 2300 | 5520 | 8280 | 11040 | 16560 |
| 6 DBAs | 24 | 80 (800) | 1200 | 2000 | 4800 | 7200 | 9600 | 14400 |

| Frame Type T950B Main - TS11xx Technology | Tape Drives | Number of Chambers | Number of Slots | Native Capacity (TB) | | | |
|--|----------------|-----------------------|--------------------|----------------------|--------|--------|--------|
| | | | | TS1140 | TS1150 | TS1155 | TS1160 |
| 1 DBAs/ shelves | 4 | 82 | 738 | 2952 | 7380 | 11070 | 14760 |
| 3 DBAs/3 TBAs or shelves | 12 | 76 | 684 | 2736 | 6840 | 10260 | 13680 |
| 6 DBAs | 24 | 66 | 594 | 2376 | 5940 | 8910 | 11880 |

Expansion Frames

The capacity of an expansion frame depends on the type of frame and its configuration. For each expansion frame, add the frame's capacity to that of the main frame to calculate the capacity of the entire library.

| Frame Type LTO Libraries | Tape Drives | Number of Chambers (Slots) | Native Capacity (TB) | | | | | |
|--------------------------------|----------------|----------------------------------|----------------------|-------|-------|--------|-------|-------|
| | | | LTO-5 | LTO-6 | LTO-7 | Type M | LTO-8 | LTO-9 |
| Drive Expansion Frame | | | | | | | | |
| 3 DBAs/ 3 TBAs | 12 | 101 (1010) | 1515 | 2525 | 6060 | 9090 | 12120 | 18180 |
| 3 DBAs/ shelves | 12 | 107 (1070) | 1605 | 2675 | 6420 | 9630 | 12848 | 19260 |
| 6 DBAs | 24 | 89 (890) | 1335 | 2225 | 5340 | 8010 | 10680 | 16020 |
| Media Expansion | None | 130 (1300) | 1950 | 3250 | 7800 | 11700 | 15600 | 23400 |
| Bulk TAP Expansion | None | 91 (910) | 1365 | 2275 | 5460 | 8190 | 10920 | 16380 |

| Frame Type TS11xx Technology | Tape Drives | Number of Chambers | Number of Slots | Native Capacity (TB) | | | |
|------------------------------------|----------------|-----------------------|--------------------|----------------------|--------|--------|--------|
| | | | | TS1140 | TS1150 | TS1155 | TS1160 |
| Drive Expansion Frame | | | | | | | |
| 3 DBAs/shelves | 12 | 90 | 810 | 3240 | 8100 | 12150 | 16200 |
| 6 DBAs | 24 | 75 | 675 | 2700 | 6750 | 10125 | 13500 |
| Media Expansion | None | 110 | 990 | 3960 | 9900 | 14850 | 19800 |
| Bulk TAP Expansion | None | 77 | 693 | 2772 | 6930 | 10395 | 13860 |

Size and Weight

The following table shows the size and weight specifications for the library frames and other components.

- Notes:**
- All dimensions and weights are approximate.
 - To calculate the approximate weight of a loaded library, calculate the total weight for all of the frames and then add the weight for each drive, RIM, and power supply, plus the weight of each TeraPack magazine full of cartridges.
 - When calculating space requirements, include the service access requirements described in [Service Access Requirements](#) on page 223.

| Parameter | Specification | | |
|------------------------------|--|--|---|
| | Main Frame | Drive Expansion Frame | Media Expansion Frame |
| Height ^a | 79.125 to 82 in. (201.0 to 208.3 cm) | | |
| Width | 29 in. (73.7 cm) | | |
| Depth ^b | 43 in. (109.2 cm) | | |
| Weight ^c | T950 6D0T: 954 lb (433 kg) 3D3T: 810 lb (367 kg) T950B 6D0T: 895 lb (406 kg) 3D3T: 876 lb (397 kg) | 6D0T: 720 lb (327 kg) 3D3T: 750 lb (340 kg) | T950 547 lb (248 kg) T950B 538 lb (244 kg) |
| Each drive (with drive sled) | <ul style="list-style-type: none"> • LTO-6: 11.6 lb (5.3 kg) • LTO-7 FH: 11.2 (5.1 kg), HH: 9.5 lb (4.3 kg) • LTO-8: FH: 11.0 (5.0 kg), HH: 9.6 lb (4.4 kg) • LTO-9: FH: 11.1 (5.0 kg) • TS11xx technology: 17.5 lb (8kg) | | N/A |

^a The height of each frame can be adjusted to allow frame-to-frame leveling on uneven floors.

^b This dimension is for the frame with the front and back cover panels installed.

^c These weights are with no drives or media installed.

| Parameter | Specification | | |
|------------------------------------|---|--|---|
| | Main Frame | Drive Expansion Frame | Media Expansion Frame |
| Each TeraPack magazine | <ul style="list-style-type: none"> • with ten LTO cartridges: 5.1 lb (2.3 kg) • with nine TS11xx technology cartridges: 5.6 lb (2.5 kg) | | |
| Each RIM | 5 lb (2.3 kg) | | N/A |
| Each power supply | 4 lb (1.8 kg) | | N/A |
| Fully loaded maximum weight | T950 6D0T: 1,722 lb (781 kg) 3D3T: 1,608 lb (729 kg) T950B 6D0T: 1,648 lb (748 kg) 3D3T: 1,535 lb (696 kg) | 6D0T: 720 lb (327 kg) 3D3T: 750 lb (340 kg) | T950 1,210 lb (549 kg) T950B 1,201 lb (545 kg) |

Service Access Requirements

Minimum Access Requirements

- A minimum of 2 ft (0.6 m) of clearance is required on the left and right ends of the library to provide service access to the library. If data center equipment is on rolling racks and can be easily moved to provide 2 ft (0.6 m) of clearance on each end of the library, then having equipment adjacent to the ends of the library is acceptable.
- A minimum of 2 ft (0.6 m) of clearance at the front and back of the main frame, each drive expansion frame, and each service or bulk TAP service frame is required for airflow and service and operator access.

Recommended Access Requirements



IMPORTANT

Providing 3 feet (0.9 meters) of clearance on each side of the library is highly recommended.

Refer to the [Spectra T950 Site Preparation Guide](#) for detailed information about space and access requirements.

Shipping and Storage Size and Weight

The following table provides the approximate dimensions and weights of the pallet and boxes used to ship the library.

| | Height | Width | Depth | Weight |
|---|------------------|------------------|------------------|---|
| Crated Frame ^a | 7.2 ft (2.2 m) | 3.5 ft (1.1 m) | 4.6 ft (1.4 m) | 1,200 to 1,300 lb ^b (544 to 590 kg) |
| Crated VAX Column^c | 8 ft (2.4 m) | 2.6 ft (0.8 m) | 2.1 ft (0.6 m) | 200 lb (91 kg) |
| Crated HAX Rail^d • 2-frame | • 6.1 ft (1.9 m) | • 2.3 ft (0.7 m) | • 1.0 ft (0.3 m) | • 110 lb (50 kg) |

^a Each frame is shipped in a separate crate. The accessory box might ship with the main frame.

^b The weight does not include drives, media, TeraPorter, or power supply modules.

^c A single frame library ships with the VAX column and HAX rail installed in the frame.

^d A single frame library ships with the VAX column and HAX rail installed in the frame.

| | Height | Width | Depth | Weight |
|--|--|--|--|---|
| <ul style="list-style-type: none"> • 3-frame • 5-frame • 6-frame • 8-frame | <ul style="list-style-type: none"> • 7.7 ft (2.3 m) • 12.5 ft (3.8 m) • 15.0 ft (4.6 m) • 7.3 ft (2.2 m) | <ul style="list-style-type: none"> • 3.0 ft (0.9 m) • 1.8 ft (0.5 m) • 1.8 ft (0.5 m) • 2.0 ft (0.6 m) | <ul style="list-style-type: none"> • 1.4 ft (0.4 m) • 0.7 ft (0.2 m) • 1.1 ft (0.3 m) • 1.4 ft (0.4 m) | <ul style="list-style-type: none"> • 150 lb (68 kg) • 120 lb (54 kg) • 120 lb (54 kg) • 85 lb (39 kg) |
| Component Pallet , a | 1.8 to 5 ft (0.6 to 1.5 m) | 3.5 to 14.9 ft (1.1 to 4.6 m) | 1.8 to 5 ft (0.6 to 1.5 m) | 200 to 400 lb (91 to 181 kg) |

Power Specifications

This section describes the power specifications for the library.

Input Power Requirements

The main frame and drive expansion frames include dual AC power modules. When using a redundant power configuration, connect each input on the dual AC power module to a separate branch circuit, which allows for failover in the event of a power failure in one of the circuits.



CAUTION

If you are installing or moving the library and connecting new power cords to it, see the [Spectra T950 Library Site Preparation Guide](#) for important information about testing the power cords.

Power Rating

Each library frame is rated at 200–240 VAC at 16 amps (3840 watts maximum). This power rating is based on a main frame with 24 LTO drives and 6 RIMs, which is the configuration for maximum power consumption by a single frame. The frames are *not* rated at 120 VAC due to the high current required to supply the product.

Power Cord Specifications

The power cords included with the library are considered part of the library and are not intended for use with any other equipment. See [Supply-End Connector Types on page 227](#) for the different types of cords available from Spectra Logic.

a The size and weight of the component pallet depends on the number and type of components shipped. To calculate the approximate weight of all the components, add 12 lb (5.4 kg) for each drive, 5 lb (2.3 kg) for each TeraPack magazine full of media, and 4 lb (1.8 kg) for each power supply.

- Notes:**
- The supply-end connector is considered the disconnect for the unit. Make sure that the socket-outlet for the AC connection is in an accessible location near the library.
 - The power cord must meet the specifications for the country where the library is installed.

North America and Korea 200–240 VAC Power Cord

The criteria for a 200-volt to 240-volt AC power cord in North America and Korea are as follows:

| Parameter | Specification |
|------------------------|---|
| Power cordage | SJT type, three-conductor, 14 AWG minimum ^a |
| Power input connectors | <ul style="list-style-type: none"> • Male: Connector must be of the proper type, rating, and safety approval (see Supply-End Connector Types on the next page). • Female: IEC 60320 C19 |

International 200–240 VAC Power Cord







The criteria for an international 200-volt to 240-volt AC power cord are as follows:

| Parameter | Specification |
|------------------------|--|
| Power cordage | Flexible, HAR (harmonized) type H05VV-F, three conductor, cord with minimum conductor size of 1.7 square millimeters (0.0026350 square inches). |
| Power input connectors | <ul style="list-style-type: none"> • Male: Connector must be of the proper type, rating, and safety approval for the intended country (see Supply-End Connector Types on the next page). • Female: IEC 60320 C19 |

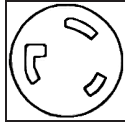
^a Power cord must comply with local electrical code.

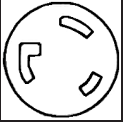
Supply-End Connector Types

The supply-end connector on the cord depends on the country where the library will be installed. The following table shows the supply-end connector types used in each country.

| Part Number | Country of Use | Plug Style | Length | Appearance | |
|-------------|------------------------------------|-------------|------------------|--|--|
| 9594 | North America, Korea | NEMA L6-20P | 14.8 ft (4.5 m) |  |  |
| 7029 | North America, Korea | NEMA L6-30P | 14.8 ft (4.5 m) | | |
| 6807 | Japan | NEMA L6-20P | 13.9 ft (4.24 m) |  |  |
| 8665 | United Kingdom, Continental Europe | IEC 60309 | 15 ft (4.6 m) |  |  |

Grounding Requirements

Due to electromagnetic interference (EMI) filtering in each dual AC power module, the leakage current for main frames and drive frames is such that they require a secure connection from the chassis of the unit to an earth ground.

Use one or more of the following methods for securing a ground connection when installing a main frame or drive frame:

- Notes:**
- Cord lock brackets and cords with locking connectors are not compatible and cannot be used simultaneously.
 - Expansion Frame Power Modules do not require locking cords or special grounding.
 - Add cord lock brackets (Spectra Logic part number 5497) to all main and drive frames. See [Maintaining The Library on page 148](#) for more information.
 - Use a cord with locking connectors at both ends, such as L6-20P to locking C19 (Spectra Logic part number 9594).

Power Consumption and Cooling Requirements

The power and cooling requirements for the library depend on the number and type of drives installed. The following table provides the maximum power consumption and heat load for the base library and for each additional component added to the base library. Use this information to calculate the total maximum power consumption and heat load values, which can be used to build a power budget for the library.

All values are measured at the AC input and include power supply efficiency. The values are averages of observed hardware. In general, the lighter the load on the power supplies, the less efficient they are. The power supply efficiency in turn affects the power draw of all components.

| Component | Power Consumption (watts) | Heat Load, Continuous (BTU/hour) |
|---|---|----------------------------------|
| Main frame ^a | 183 | 625 |
| Drive frame ^b | 139 | 475 |
| Media frame with fan | 110 | 376 |
| Media frame without fan | 14 | 48 |
| Bulk TAP frame | 125 | 427 |
| 5/12 VDC power supply | 33 | 113 |
| 24 VDC power supply | 29 | 99 |
| RIM | 12 | 41 |
| LTO-9 Fibre Channel Full-Height | • Read/write: 35 | Read/write: 119 |
| LTO-9 Fibre Channel or SAS Half-Height | • Read/write: 35 | Read/write: 119 |
| LTO-8 Fibre Channel Full-Height | • Read/write: 40 • Idle: 15 ^c | Read/write: 136 |

^a Assumes one 5/12 volt power supply and one 24 volt power supply; no drives or RIMs installed.

^b Assumes one 5/12 volt power supply and one 24 volt power supply; no drives or RIMs installed.

^c No cartridge loaded.

| Component | Power Consumption (watts) | Heat Load, Continuous (BTU/hour) |
|--|---|----------------------------------|
| LTO-8 Fibre Channel or SAS Half-Height | <ul style="list-style-type: none"> • Read/write: 43 • Idle: 14 ^d | Read/write: 146 |
| LTO-7 Fibre Channel Full-Height | <ul style="list-style-type: none"> • Read/write: 31 • Idle: 20 ^c | Read/write: 106 |
| LTO-7 Fibre Channel or SAS Half-Height | <ul style="list-style-type: none"> • Read/write: 31 • Idle: 20 ^d | Read/write: 106 |
| LTO-6 Fibre Channel | <ul style="list-style-type: none"> • Read/write: 28 • Idle: 8 ^d | Read/write: 95 |
| TS1160 technology | <ul style="list-style-type: none"> • Read/write: 67 • Idle: 35 ^d | Read/write: 229 |
| TS1155 technology | <ul style="list-style-type: none"> • Read/write: 60 • Idle: 19 ^d | Read/write: 205 |
| TS1150 technology | <ul style="list-style-type: none"> • Read/write: 55 • Idle: 38 ^d | Read/write: 188 |
| TS1140 technology | <ul style="list-style-type: none"> • Read/write: 53 • Idle: 30 ^d | Read/write: 181 |

Environmental Specifications

This section describes environmental specifications for the library. Do not place the library on a carpeted floor or anywhere else that poses risk for static discharge that could damage the library and its drives.



CAUTION

The library must be installed on a level, hard-surfaced floor such as cement or tile. Never install it on carpeted flooring.

The library is equipped with internal fans that operate as much as is necessary for the number of DBAs installed. The fans keep the library's internal temperature within specifications as long as the data center environment is within specifications.

**CAUTION**

When the library is moved from a cold environment to a warm environment, it should not be powered on for at least 24 hours. This adjustment period prevents condensation damage.

The following tables list the general environmental specifications for the library.

All LTO Drives, TS1150, TS1155, and TS1160 Drives

| Mode | Dry-bulb Temperature | Maximum Temperature Rate of Change ^a | Relative Humidity (non-condensing) | Maximum Humidity Rate of Change | Maximum Altitude |
|-------------------------|------------------------------------|---|--|----------------------------------|-----------------------|
| Allowable Environment | 16° C to 32° C (60° F to 90° F) | 5° C per hour 9° F per hour | 20% to 80% 22° C dew point max (72° F) | 5% per hour with no condensation | 3048 m (10,000 ft) |
| Recommended Environment | 16° C to 25° C (60° F to 77° F) | 5° C per hour 9° F per hour | 20% to 50% 22° C dew point max (72° F) | 5% per hour with no condensation | 3048 m (10,000 ft) |

TS1170 Drives

| Mode | Dry-bulb Temperature | Maximum Temperature Rate of Change ^b | Relative Humidity (non-condensing) | Maximum Humidity Rate of Change | Maximum Altitude |
|-----------------------|------------------------------------|---|--|----------------------------------|-----------------------|
| Allowable Environment | 16° C to 25° C (60° F to 77° F) | 5° C per hour 9° F per hour | 20% to 50% 22° C dew point max (72° F) | 5% per hour with no condensation | 3048 m (10,000 ft) |

^a The temperature and humidity must be allowed to stabilize in the specified ambient environment for 24 hours.

^b The temperature and humidity must be allowed to stabilize in the specified ambient environment for 24 hours.

| Storing ^a and Shipping (Non-Operating) Environment Specification | |
|--|------------------------------------|
| Humidity | 10% to 95% (non-condensing) |
| Temperature | -40° F to 149° F (-40° C to 65° C) |
| Altitude | Sea level to 40,000 ft (12,192 m) |

Shock and Vibration Specifications

The library will operate normally after experiencing shock loads as specified in the following table. The operating shock levels indicate how much shock the library can withstand while the enclosed drives are reading and writing data. The non-operating and storage shock levels indicate how much shock the library can withstand when it is not operating. After experiencing this amount of shock, the library will operate normally.

| Specification | Operating | Storing and Shipping (Non-Operating Environment) ^b |
|---------------------------|--|---|
| Shock | 2 g pk ½ sine wave for 10 msec (3 axes, 2 shocks per axis, minimum) | 2 g pk ½ sine wave for 10 msec (3 axes, 2 shocks per axis, minimum) |
| Vibration (Swept Sine) | 5 Hz – 500 Hz – 5 Hz 5 – 22 Hz, 0.01-inch DA displacement 22 – 500 Hz, 0.25G pk @ ½ octave (minimum three axes) | 5 Hz – 500 Hz – 5 Hz 5 – 31 Hz, 0.02-inch DA displacement 31 – 500 Hz, 1G pk @ ½ octave (minimum three axes) |
| Vibration (Random) | 0.5 Grms, 0 – 3000 Hz (single axis) | 1 – 200 Hz @ 1.156 Grms. Bottom face only for 60 minutes. |

^a The library is in its original packaging. The packaging is designed to protect the library from condensation caused by extreme temperature variations of 27° F (15° C) or more. When the library is moved from a cold storage environment to a warm operating environment, it must be acclimated in its packaging for at least 24 hours before opening to prevent serious condensation damage from occurring.

^b Specifications are for the library in its original packaging.

INTERFACE SPECIFICATIONS

This section provides information about the interfaces used to connect the library and tape drives to the host systems. It also provides information about the Ethernet interface used to access the library's LumOS web interface.

Direct-attached tape drives have a native Fibre Channel or SAS interface; direct-attached SCSI drives are not supported.

For information about how IBM drives support SAS communications, refer to the tape drive documentation, available from IBM at ibm.com/support/knowledgecenter/.

Component Interface Connectors

| Component | Physical Interface |
|--|--|
| Drive, direct-attached Fibre Channel | Two dual port multimode optical LC connectors ^a |
| Drive, direct-attached SAS - LTO-6 through LTO-8 | Two SFF-8088 connectors |
| Drive, direct-attached SAS - LTO-9 and LTO-10 | Two SFF-8644 connectors |

Network Interface Cable Requirements

The type of cables required to connect the library and its drives to the network depend on the type of interface being used.

Library Access

Provide a Category 5 (10/100/1000 Base-T connection) data-grade Ethernet cable that is compliant with EIA/TIA 568 from an active Ethernet network to be connected to an Ethernet port on the LCM (each Ethernet port is a pin-through-hole RJ-45 shielded connector) to support remote access to the library's LumOS user interface and to allow the library to automatically email notifications to users.



CAUTION Some port scanning software can interfere with remote library sessions.

^a Only one port at a time can be used to connect the drive to a Fibre Channel network. If desired, the two ports can be used to create a failover configuration.

Tape Drive Access

- **Fibre Channel**

Provide one optical fiber cable from the arbitrated loop or switched fabric, to a Fibre Channel port on each drive, to provide the hosts with access to the partitions. Depending on the wavelength, the cables must comply with the following specifications in the Fibre Channel standard (FC-PI-2):

- **50-micron**—400-M5-SN-I classification
- **62.5 micron**—400-M6-SN-I classification (not supported for LTO-6 or later generation drives)

Use the following table to determine the maximum length for an M5 cable.

| Data Rate / Link Speed | M5 (OM2) cable | M5E (OM3) cable | M5F (OM4) cable |
|------------------------|-----------------|-----------------|-----------------|
| 1 Gbps | 1640 ft (500 m) | Not Specified | Not Specified |
| 2 Gbps | 984 ft (300 m) | Not Specified | Not Specified |
| 4 Gbps | 492 ft (150 m) | 1247 ft (380 m) | 1312 ft (400 m) |
| 8 Gbps | 164 ft (50 m) | 492 ft (150 m) | 623 ft (190 m) |

- **Serial Attached SCSI (SAS)**

SAS tape drives support the point-to-point Serial Attached SCSI protocol.

- **LTO-7 and LTO-8** - Connecting these drives to the host network requires an SFF-8088 SAS cable rated for 6 Gb/second that does not exceed 13 feet (4 m).
- **LTO-9 and LTO-10** - Connecting these drives to the host network requires an SFF-8644 SAS cable rated for 12 Gb/second that does not exceed 13 feet (4 m).

Universal Serial Bus (USB) Support

Spectra Logic supports using the USB ports on the LCM for the following:

- USB mass storage devices (for example, flash drives)
- Keyboards
- Pointer devices (for example, a computer mouse)
- External Drives (HD, CD, DVD, and Flash) with a USB interface



IMPORTANT The library only recognizes FAT-formatted, not NTFS-formatted, USB devices.

NDMP Support

Spectra Logic tape libraries are compatible with local, remote, and three-way NDMP (Network Data Management Protocol) topologies, where the tape library is connected to the NDMP data mover host over Fibre Channel.

TAPE DRIVE AND MEDIA SPECIFICATIONS

This section provides the basic specifications for the tape drives and media supported by the library.

- Notes:**
- The specifications in this section are provided for convenience only. Refer to the tape drive documentation for the most current specifications (see [LTO Ultrium Tape Drives on page 16](#) and [TS11xx Technology Drives on page 16](#)).
 - The specifications in this section are subject to change without notice.

LTO Tape Drive Specifications

This section provides specifications for the LTO drives supported by the library. See [Tape Media Specifications on page 242](#) for information about the media used in the library.

Note: LTO drives and media are also referred to as Ultrium or LTO Ultrium drives and media.

LTO-10 Drive

When connecting to a Fibre Channel network, LTO-10 Fibre Channel drives will attempt to connect at 32 Gb/second, but will auto-negotiate down depending on the requirements of the port to which the drive is connected.

LTO-10 SAS drives attempt to connect at 12 Gb/second, but auto-negotiate down to 6 Gb/second or 3 Gb/second, depending on the requirements of the port to which the drive is connected.

| Parameter | Specification |
|---|---|
| Maximum sustained transfer rate ^a , b | 400 MB/second, native 1000 MB/second, compressed SAS 1200 MB/second, compressed Fibre |
| Speed matching range | 157 MB/second to 407 MB/second |
| Average space record time | 45 seconds |
| Encryption capability | AES 256-GCM |

a Assuming a 2.5:1 compression ratio. Compression throughput depends on the type of data.

b This is a per-drive value. Total sustained transfer rate for the library depends on the number of drives installed in the library.

| Parameter | Specification |
|------------------------------------|--|
| WORM capability | Yes |
| MTBF | 250,000 hours at 100% duty cycle |
| Uncorrected error rate, calculated | 1×10^{-19} bits |
| Power consumption | Read/write: 39.8 watts typical Idle: 27.5 watts (empty drive) |

LTO-9 Drive

When connecting to a Fibre Channel network, LTO-9 Fibre Channel drives will attempt to connect at 8 Gb/second, but will auto-negotiate down to 4 Gb/second, or 2 Gb/second, depending on the requirements of the port to which the drive is connected.

LTO-9 SAS drives attempt to connect at 12 Gb/second, but auto-negotiate down to 6 Gb/second or 3 Gb/second, depending on the requirements of the port to which the drive is connected.

| Parameter | Specification |
|--|---|
| Maximum sustained transfer rate ^a ^b | 400 MB/second, native 900 MB/second, compressed SAS 700 MB/second, compressed Fibre |
| Speed matching range | 177 MB/second to 400 MB/second |
| Average space record time | TBD |
| Encryption capability | AES 256-GCM |
| WORM capability | Yes |
| MTBF | 250,000 hours at 100% duty cycle |
| Uncorrected error rate, calculated | 1×10^{-20} bits |
| Power consumption | Read/write: 34 watts typical Idle: TBD |

a Assuming a 2.5:1 compression ratio. Compression throughput depends on the type of data.

b This is a per-drive value. Total sustained transfer rate for the library depends on the number of drives installed in the library.

LTO-8 Drive

When connecting to a Fibre Channel network, LTO-8 Fibre Channel drives will attempt to connect at 8 Gb/second, but will auto-negotiate down to 4 Gb/second, or 2 Gb/second, depending on the requirements of the port to which the drive is connected.

LTO-8 SAS drives attempt to connect at 6 Gb/second, but auto-negotiate down to 3 Gb/second or 1.5 Gb/second, depending on the requirements of the port to which the drive is connected.

| Parameter | Specification |
|--|--|
| Maximum sustained transfer rate ^a ^b | 360 MB/second, native 750 MB/second, compressed |
| Speed matching range | 112 MB/second to 360 MB/second |
| Average space record time | 59 seconds |
| Encryption capability | AES 256-GCM |
| WORM capability | Yes |
| MTBF | 250,000 hours at 100% duty cycle |
| Uncorrected error rate, calculated | 1×10^{-19} bits |
| Power consumption | Read/write: 40 watts typical Idle: 15 watts |

LTO-7 Drive

When connecting to a Fibre Channel network, LTO-7 Fibre Channel drives will attempt to connect at 8 Gb/second, but will auto-negotiate down to 4 Gb/second, or 2 Gb/second, depending on the requirements of the port to which the drive is connected.

LTO-7 SAS drives attempt to connect at 6 Gb/second, but auto-negotiate down to 3 Gb/second or 1.5 Gb/second, depending on the requirements of the port to which the drive is connected

^a Assuming a 2.5:1 compression ratio. Compression throughput depends on the type of data.

^b This is a per-drive value. Total sustained transfer rate for the library depends on the number of drives installed in the library.

| Parameter | Specification |
|--|--|
| Maximum sustained transfer rate ^a , ^b | 300 MB/second, native 750 MB/second, compressed |
| Speed matching range | 100 MB/second to 300 MB/second |
| Average space record time | 56 seconds |
| Encryption capability | AES 256-GCM |
| WORM capability | Yes |
| MTBF | 250,000 hours at 100% duty cycle |
| Uncorrected error rate, calculated | 1×10^{-19} bits |
| Power consumption | Read/write: 31 watts typical Idle: 20 watts |

LTO-6 Drive

When connecting to a Fibre Channel network, LTO-6 Fibre Channel drives will attempt to connect at 8 Gb/second, but will auto-negotiate down to 4 Gb/second, 2 Gb/second, or 1 Gb/second, depending on the requirements of the port to which the drive is connected.

| Parameter | Specification |
|--|---|
| Maximum sustained transfer rate ^c , ^d | 160 MB/second, native ^e 400 MB/second, compressed |
| Speed matching range | 40 MB/second to 160 MB/second |
| Average space record time | 77 seconds |
| Encryption capability | AES 256-bit |
| WORM capability | Yes |

^a Assuming a 2.5:1 compression ratio. Compression throughput depends on the type of data.

^b This is a per-drive value. Total sustained transfer rate for the library depends on the number of drives installed in the library.

^c Assuming a 2.5:1 compression ratio. Compression throughput depends on the type of data.

^d This is a per-drive value. Total sustained transfer rate for the library depends on the number of drives installed in the library.

^e A 1 Gb interface speed will not stream an LTO-6 drive at 160 MB/second.

| Parameter | Specification |
|------------------------|---|
| MTBF | 250,000 hours at 100% duty cycle |
| Uncorrected error rate | 1×10^{-17} bits |
| Power consumption | Read/write: 28 watts typical Idle: 8 watts |

TS11xx Technology Tape Drive Specifications

This section provides specifications for the TS11xx technology drives.

Note: The specifications in this section are provided for convenience only. Refer to the tape drive documentation for the most current specifications (see TS11xx Technology Drives on page 16).

TS1170 Technology Drive

| Parameter | Specification |
|---|--|
| Maximum sustained transfer rate with JF media ^a ^b | 400 MB/second, native 900 MB/second, compressed |
| Speed matching range | 112 MB/second to 365 MB/second |
| Media compatibility | Only compatible with JF media. No backwards compatibility. |
| Average file access time | 55 seconds |
| Encryption capability | AES 256-GCM |
| WORM capability | No |
| MTBF | 250,000 hours at 100% duty cycle |
| Uncorrected error rate | 1×10^{-21} bits |
| Power consumption | Read/write: 64 watts maximum Idle: 40 watts |

^a Assuming a 2.5:1 compression ratio. Compression throughput depends on the type of data.

^b This is a per-drive value.

TS1160 Technology Drive

| | |
|--|--|
| | |
| | |
| | |
| | |
| | |
| | |
| | |
| | |
| | |
| | |

TS1155 Technology Drive

| Parameter | Specification |
|---|--|
| Maximum sustained transfer rate ^a ^b | 360 MB/second, native 700 MB/second, compressed |
| Speed matching range | JD: 112 MB/second to 365 MB/second JC (TS1150 technology format): 99 MB/second to 303 MB/second JC (TS1140 technology format): 90 MB/second to 252 MB/second |
| Average file access time | 55 seconds |
| Encryption capability | AES 256-GCM |
| WORM capability | Yes |
| MTBF | 237,000 hours at 100% duty cycle |
| Uncorrected error rate | 1 x 10 ⁻²⁰ bits |
| Power consumption | Read/write: 60 watts maximum Idle: 19 watts |

^a Assuming a 2.5:1 compression ratio. Compression throughput depends on the type of data.

^b This is a per-drive value.

TS1150 Technology Drive

| Parameter | Specification |
|---|--|
| Maximum sustained transfer rate ^a ^b | 360 MB/second, native 700 MB/second, compressed |
| Speed matching range | JD: 112 MB/second to 365 MB/second JC (TS1150 technology format): 99 MB/second to 303 MB/second JC (TS1140 technology format): 90 MB/second to 252 MB/second |
| Average file access time | 55 seconds |
| Encryption capability | AES 256-GCM |
| WORM capability | Yes |
| MTBF | 237,000 hours at 100% duty cycle |
| Uncorrected error rate | 1×10^{-20} bits |
| Power consumption | Read/write: 46 watts maximum Idle: 22.3 watts |

TS1140 Technology Drive

| Parameter | Specification |
|---|--|
| Maximum sustained transfer rate ^c ^d | 250 MB/second, native 650 MB/second, compressed |
| Speed matching range | 76 MB/second to 251 MB/second |
| Average file access time | 54 seconds |
| Encryption capability | AES 256-GCM |
| WORM capability | Yes |

^a Assuming a 2.5:1 compression ratio. Compression throughput depends on the type of data.

^b This is a per-drive value.

^c Assuming a 2.5:1 compression ratio. Compression throughput depends on the type of data.

^d This is a per-drive value.

| Parameter | Specification |
|------------------------|--|
| MTBF | 237,000 hours at 100% duty cycle |
| Uncorrected error rate | 1×10^{-20} bits |
| Power consumption | Read/write: 51 watts maximum Idle: 24 watts |

Drive-Based Encryption Highlights

Key

AES-256 data encryption with a secret 256-bit encryption key is used to encrypt and decrypt data. The key is not retrievable from the encryption core and is automatically erased during the unload process; software is required to extract the key, keep it secure, and provide management tools to track, store, use, and delete keys as appropriate.

Note: Spectra SKLM key management is not compatible with BlueScale Encryption key management, because they cannot share encryption keys. Data encrypted using Spectra SKLM key management cannot be decrypted using BlueScale Encryption key management, and vice versa.

For more information about encryption, see the [Spectra Tape Libraries Encryption User Guide](#).

Tape Media Specifications

This section provides specifications for the tape media supported by the library.

Environmental Requirements

The following table lists the specifications for storage temperature and other environmental requirements for tape media. Do not allow the temperature and humidity in the storage environment to fluctuate.

| Specification | Recommended Operating | LTO-9 and LTO-10 Allowable Operating ^a | LTO-8 and Lower Allowable Operating ^a | TS11xx Allowable Operating ^a | Shipping ^b |
|------------------------------|------------------------------------|---|--|---|--------------------------------------|
| Temperature | 59° F to 77° F (15° C to 25° C) | 59° F to 95° F (15° C to 35° C) | 50° F to 113° F (10° C to 45° C) | 61° F to 90° F (16° C to 32° C) | -9° F to 120° F (-23° C to 49° C) |
| Relative humidity | 20% to 50% | 10% to 80% | 10% to 80% | 10% to 80% | 5% to 80% |
| Max dew point | 72° F (22° C) | 71.6° F (22° C) | 79° F (26° C) | 79° F (26° C) | 79° F (26° C) |
| Maximum humidity rate change | 5% / hour with no condensation | 5% / hour with no condensation | 5% / hour with no condensation | 5% / hour with no condensation | |
| Maximum Altitude | 10,000 ft 3048 m | 10,000 ft 3048 m | 10,000 ft 3048 m | 10,000 ft 3048 m | 40,000 ft 12192 m |

LTO Media Specifications

The following table shows the capacities of the different generations of LTO Ultrium data cartridges.

| LTO Media Generation | Native Capacity (Compressed Capacity) ^c |
|------------------------|--|
| LTO-6 and LTO-6 WORM | 2.5 TB (6.25 TB) |
| LTO-7 and LTO-7 WORM | 6 TB (15 TB) |
| LTO-7 Type M | 9 TB (22.5 TB) |
| LTO-8 and LTO-8 WORM | 12 TB (30 TB) |
| LTO-9 and LTO-9 WORM | 18 TB (45 TB) |
| LTO-10 and LTO-10 WORM | 30 TB (75 TB) |

^a The upper limit applies to the media, not the library. Be sure there is adequate air flow around the library at all times.

^b When media is moved from a cold shipping/storage environment to a warm operating environment, it must be acclimated in its packaging for at least 24 hours before opening to prevent condensation damage from occurring.

^c Assuming a 2.5:1 compression ratio. The compressed capacity depends on the type of data.

LTO Read/Write Compatibility

The following table shows the media read/write compatibility for each LTO drive generation supported by the library.

| Drive Gen | LTO-4 Media | LTO-5 Media | LTO-6 Media | LTO-7 Media | M8 Media | LTO-8 Media | LTO-9 Media | LTO-10 Media |
|-----------|------------------|-------------------|-------------------|-------------------|-------------------|-------------------|-------------------|-------------------|
| LTO-6 | <i>Read only</i> | Read/write | Read/write | Not supported | Not supported | Not supported | Not supported | Not supported |
| LTO-7 | Not supported | <i>Read only</i> | Read/write | Read/write | Not supported | Not supported | Not supported | Not supported |
| LTO-8 | Not supported | Not supported | Not supported | Read/write | Read/write | Read/write | Not supported | Not supported |
| LTO-9 | Not supported | Not supported | Not supported | Not supported | Not supported | Read/write | Read/write | Not supported |
| LTO-10 | Not supported | Not supported | Not supported | Not supported | Not supported | Not supported | Not supported | Read/write |

TS11xx Technology Media Specifications

The following table shows the capacities of TS11xx technology data cartridges.

| Media type | Native Capacity (Compressed Capacity ^a) |
|----------------|---|
| JC / JY (WORM) | (TS1140 technology format): 4 TB (10 TB) (TS1150 technology format): 7 TB (17.5 TB) |
| JD / JZ (WORM) | (TS1150 technology format): 10 TB (25 TB) (TS1155/60 technology format): 15 TB (37.5 TB) |

^a Assuming a 2.5:1 compression ratio. The compressed capacity depends on the type of data.

| Media type | Native Capacity (Compressed Capacity ^a) |
|----------------|--|
| JE / JV (WORM) | (TS1160 technology format): 20 TB (50 TB) |
| JF | (TS1170 technology format): 50 TB (150 TB) |

TS11xx Technology Read/Write Compatibility

The following table shows the media read/write compatibility for each TS11xx technology drive generation supported by the library.

| Drive Generation | JC Media | JD Media | JE Media | JF Media |
|------------------|------------------|---------------|---------------|---------------|
| TS1140 | Read/write | Not supported | Not supported | Not supported |
| TS1150 | Read/write | Read/write | Not supported | Not supported |
| TS1155 | Read/write | Read/write | Not supported | Not supported |
| TS1160 | <i>Read only</i> | Read/write | Read/write | Not supported |
| TS1170 | Not supported | Not supported | Not supported | Read/write |

WORM Media

Certain records retention and data security applications require a Write Once, Read Many (WORM) method for storing data on tape. LTO-6 and later generation drives and TS11xx technology drives enable WORM support when a WORM tape cartridge is loaded into the drive.

WORM Media Requirements

Because standard read/write media are incompatible with the WORM feature, a specially formatted WORM tape cartridge is required. Each WORM cartridge has a unique, worldwide cartridge identifier (WWCID), which comprises the unique CM chip serial number and the unique tape media serial number.

Data Security on WORM Media

Certain built-in security measures help ensure that the data written on a WORM cartridge does not become compromised, for example:

^a Assuming a 2.5:1 compression ratio. The compressed capacity depends on the type of data.

- The format of a WORM tape cartridge is unlike that of standard read/write media. This unique format prevents a drive that lacks WORM-capable firmware from writing on a WORM tape cartridge.
- When the drive senses a WORM cartridge, the firmware prohibits the changing or altering of user data already written on the tape. The firmware keeps track of the last appendable point on the tape.

Cleaning Cartridges

Cleaning cartridges are valid for 50 uses. Do not rewind and reuse the material in a cleaning cartridge. Reusing the material may redistribute contaminants previously removed from the tape path. If all of the cleaning material has been used, discard the cartridge and use a new cleaning cartridge.

Barcode Label Specifications

Symbology

The barcode labeling scheme used on Spectra Logic certified media uses the barcode symbology of USS-39. You can obtain a complete description and definition of this symbology from the *Automatic Identification Manufacturers (AIM) specification*, the *Uniform Symbol Specification (USS-39)*, and the *ANSI MH10.8M-1993 ANSI Barcode specification*.

Application and Orientation

The barcode label must be applied to the cartridge so that it fits within the label recess on the edge of the cartridge without curling up on the sides or ends. The label must be oriented so that the barcode characters are along the edge closest to the hub side of the cartridge.

Printed Characters

The label can have human-readable alphanumeric characters printed along the top or bottom edge of the label provided there is no conflict or interference with the automation code. This text must include the barcode data, but can also include additional text. The format and colors of the human readable characters is up to the customer and label vendor. For location restrictions, see [Detailed Specifications for LTO Cartridge Barcodes on page 248](#) and [Detailed Specifications for TS11xx Technology Cartridge Barcodes on page 249](#).

Note: When using barcode labels with alphanumeric characters along the bottom edge, the label must be positioned so that barcode is at least 13.72 mm below the top edge of the cartridge to ensure that the barcode reader can read the label.

Barcode Data

The library supports barcode data strings consisting of from 1 to 16 characters, including an optional checksum character. Quiet zones precede and follow the start and stop characters.

The barcode data string on standard Spectra Logic barcode labels consists of a start character, eight alphanumeric characters, a checksum character, and the stop character. Quiet zones precede and follow the start and stop characters.

- The first six (6) characters following the start character can be any combination of upper case A-Z or 0-9 (for example, ABC123) to identify the cartridge Volume Serial Number. The use of "CLN" and "DG{space}" at the beginning of the volume identifier is reserved.
 - The volume identifier "CLN vnn " is reserved for cleaning cartridges. When a drive requires cleaning, it requests a specific type of cleaning cartridge.
 - The " v " field is an alphanumeric field to identify cleaning cartridge applications, "U" for Universal Cleaning Cartridges or a drive unique identifier.
 - The " nn " alphanumeric field is used to track individual cleaning cartridge activity (that is, usage and life).
 - The volume identifier "DG{space} vnn " is reserved for diagnostic and service cartridges.
- The last two (2) characters are the media identifier and indicate the cartridge Media Type (for example, "L" for LTO and "6" for an LTO-6 cartridge or "J" for a TS11xx technology cartridge). In IBM LTO tape drives, the value of the media identifier on cleaning cartridges is ignored, although a valid value must be present.
- The barcode string can be printed in either direction on the label and must begin and end with a valid start/stop character (*).
- The label must be printed so that barcode data is positioned along the edge of the label that will be closest to the hub side of the cartridge.

The *AIM Uniform Symbol USS-39* specification provides detailed information about the format of the start character, the series of characters that make up the barcode data, the optional checksum character, and the stop character.

Detailed Specifications for LTO Cartridge Barcodes

Figure 140 shows the dimensional specifications for LTO labels with the alphanumeric characters above the barcode.

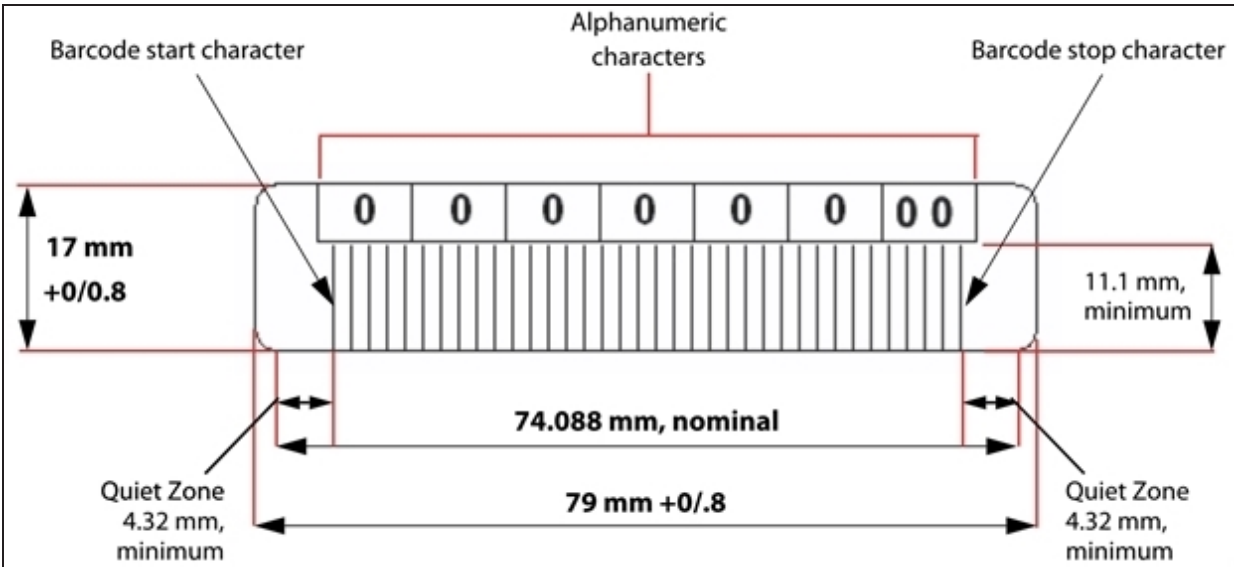

Figure 140 Barcode specifications for LTO media; alphanumeric characters on top.

Note: When using barcode labels with alphanumeric characters along the bottom edge, the label must be positioned so that barcode is at least 13.72 mm below the top edge of the cartridge to ensure that the barcode reader can read the label.

LTO Barcode Element Specifications

For the official IBM barcode label specification, see ibm.com/support/pages/node/651699. Unless otherwise specified, tolerances are $X.XXX \pm 0.127$ mm, $X.XXX \pm 0.762$ mm.

- Minimum symbol height is 11.1 mm, measured to the inside of the label's edge.
- The wide-to-narrow ratio is 2.75.
- The narrow element width is 0.432 mm $+0.03$ mm or -0.076 mm.
- The nominal width of the wide spaces and bars is 1.188 mm.
- The inter-character gap is 0.432 mm $+0.03/-0.076$ mm.
- The minimum quiet zone at the beginning and end of a printed barcode string is 4.32 mm (10 times the narrow element width).
- The total nominal barcode string length (including quiet zones) is 74.088 mm.
- The edge of the barcode is the edge of the printed area associated with the bar. The edge roughness is the transition encountered as a horizontal line is moved vertically from all black to all white. The edge roughness maximum is 0.038 mm.
- Variation between all bars, white and black, must be less than ± 0.0381 mm.

LTO Physical Label Specifications

- Label stock must fit within the label recess on the face of the cartridge without curling up on the sides or ends (79 mm X 17 mm +0/-0.8).
- Minimum length sufficient for the quiet zones, start-stop, and data characters (nominal 74.088 mm).
- Minimum width no less than 1.5 mm narrower than the cartridge label recess width. Corners are cut with a 1.5 mm radius.
- Maximum label thickness, including the RFID tag, if present, together with any associated layers and adhesives cannot exceed 0.40 mm.
- The label and adhesive must have an environmental performance to match or exceed the environmental specifications of the cartridge to which it is applied.

Detailed Specifications for TS11xx Technology Cartridge Barcodes

Figure 141 shows the dimensional specifications for TS11xx technology labels with the alphanumeric characters above the barcode.

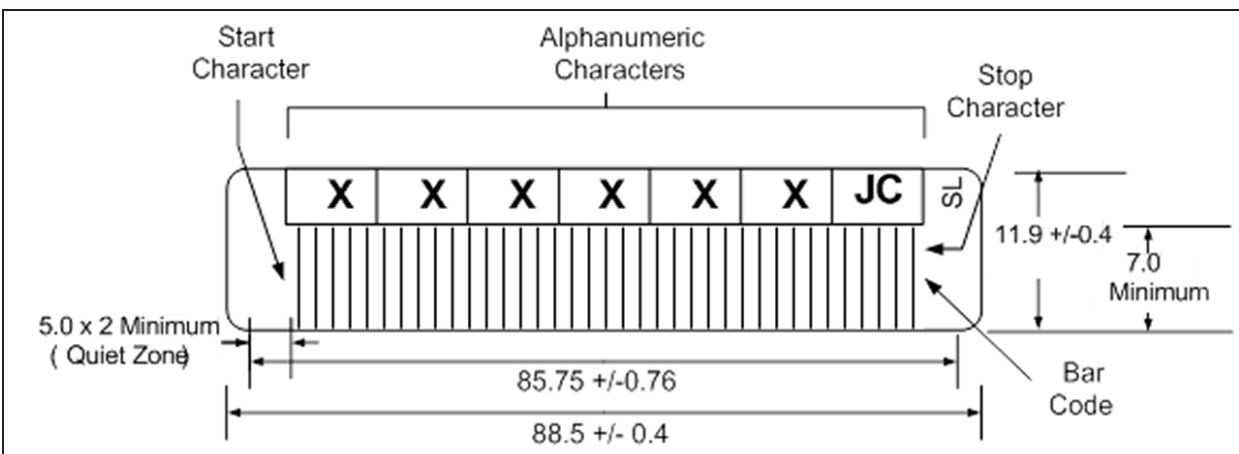

Figure 141 Barcode specifications for TS11xx technology media; alphanumeric characters on top. All measurements are in millimeters.

Note: When using barcode labels with alphanumeric characters along the bottom edge, the label must be positioned so that barcode is at least 13.72 mm below the top edge of the cartridge to ensure that the barcode reader can read the label.

TS11xx Technology Barcode Element Specifications

For the official IBM barcode label specification, see ibm.com/support/pages/node/651747. Unless otherwise specified, tolerances are X.XXX ± 0.127 mm, X.XX ± 0.76 mm.

- Minimum symbol height is 7.1 mm, measured to the inside of the label's edge.
- The wide-to-narrow ratio is 2.75.

- The narrow element width is 0.500 mm + 0.03/- 0.07 mm.
- The nominal width of the wide spaces and bars is 1.375 mm.
- The inter-character gap is 0.500 mm + 0.03/- 0.07 mm.
- The minimum quiet zone at the beginning and end of a printed barcode string is 5.0 mm (10 times the narrow element width).
- The total nominal barcode string length (including quiet zones) is 85.75 mm.
- The edge of the barcode is the edge of the printed area attached to the bar. The edge roughness is the transition encountered as a horizontal line is moved vertically from all black to all white. The edge roughness maximum is 0.04 mm.
- Variation between all bars, white and black, must be less than ± 0.04 mm.

TS11xx Technology Physical Label Specifications

- Label stock must fit within the label recess on the face of the cartridge without curling up on the sides or ends (88.5 mm X 11.9 mm +0/-0.4).
- Minimum length sufficient for the quiet zones, start-stop, and data characters (nominal 85.75 mm).
- Minimum width no less than 1.5 mm narrower than the cartridge label recess width. Corners are cut with a 1.5 mm radius.
- Maximum label thickness, including the RFID tag, if present, together with any associated layers and adhesives cannot exceed 0.75 mm.
- The label and adhesive must have an environmental performance to match or exceed the environmental specifications of the cartridge to which it is applied.

INTEROPERABILITY AND SOFTWARE COMPATIBILITY

You can find complete interoperability listings, as well as a list of the types of software that have been tested and proven compatible with the library on the Spectra Logic website at spectralogic.com/compatibility.

APPENDIX C - REGULATORY & SAFETY STANDARDS

The Spectra T950 library complies with the safety and regulatory agency standards listed below when installed by a Spectra Logic certified engineer or third-party provider.

| | |
|--|------------|
| EU Declaration of Conformity | 253 |
| Emission Standards | 254 |
| Safety Standards and Compliance | 255 |
| Nemko Accreditation | 256 |
| Environmental Regulations | 257 |
| Conflict Minerals Policy | 259 |

EU DECLARATION OF CONFORMITY



Document # 99100001 V7.0

DECLARATION OF CONFORMITY
According to ISO/IEC 17050-1:2004



Manufacturer's Name: Spectra Logic Corporation
Manufacturer's Address: 6101 Lookout Road, Boulder CO,80301

Declares under sole responsibility that the product as delivered

Product Name: TFinity
Model Number: TFinity, T950, T950e. T950V
Product options: This declaration covers all options of the above product(s)

Complies with the essentials of the following European Directives, and carries the CE marking accordingly:

Safety
Directive: 2014/35/EU IEC 62368-1:2018 (Third Edition)
EN 60950-1:2006 +A11:2009 +A1:2010 +A12:2011 +A2:2013
EN 62479:2010

Electromagnetic Compatibility
Directive 2014/30/EU EN55032: 2012, Class A
EN55024: 2010 EN 61000 3-2:2014
EN 61000 3-3:2013

Restriction of the use of certain hazardous substances
IEC 63000 / EN 50581-2012 EN 62321
(EC)1907/2006 REACH 2011/65/EU RoHS
2012/19/EU WEEE

Mike Beaty
Sr. Director Operations
September 20, 2023

6101 Lookout Road
Boulder, CO 80301

www.SpectraLogic.com
+1 303-449-6400 Worldwide
+1 800-833-1132 US/Canada

EMISSION STANDARDS

The Spectra T950 library complies with the following domestic and international emission standards.

| Country | Standard |
|-----------------------|--|
| United States - FCC | CFR Title 47, FCC Part 15 (see FCC Notice) |
| Australia/New Zealand | AS/NZS CISPR 32: 2015 |
| Canada | ICES-003 |
| Japan | VCCI |
| Korea | KN 22 |
| Taiwan | CNS 13438 |

FCC Notice

This equipment has been tested and found to comply with the limits for a Class A digital device, pursuant to CFR 47, Part 15 of the FCC Rules. These limits are designed to provide reasonable protection against harmful interference when the equipment is operated in a commercial environment. This equipment generates, uses, and can radiate radio frequency energy, and, if not installed and used in accordance with the instruction manual, may cause harmful interference to radio communications. Operation of this equipment in a residential area is likely to cause harmful interference, in which case the user will be required to correct the interference at the user's own expense.

Korean Notice

| 기종별 | 사용자 안내문 |
|------------------------|---|
| A급 기기 (업무용 방송통신기자재) | 이 기기는 업무용(A급) 전자파적합기기로서 판매자 또는 사용자는 이 점을 주의하시기 바라며, 가정외의 지역에서 사용하는 것을 목적으로 합니다. |

SAFETY STANDARDS AND COMPLIANCE

Product Safety Standards

The Spectra T950 library complies with the following domestic and international product safety standards.

- Directive: 2014/35/EU
- EN 60950-1:2006 +A11:2009 +A1:2010 +A12:2011 +A2:2013
- EN 62479:2010
- CAN/CSA C22.2 No. 60950-1-03 (Canada: cNemko Mark)

Laser Warning

IBM Tape Drives

A Class 1 laser assembly, in the optical transceiver, is mounted on each IBM tape drive Fibre Channel electronics card. This laser assembly is registered with the DHHS and is in compliance with IEC825.

These products contain components that comply with performance standards that are set by the U.S. Food and Drug administration. This means that these products belong to a class of laser products that do not emit hazardous laser radiation. This classification was accomplished by providing the necessary protective housings and scanning safeguards to ensure that laser radiation is inaccessible during operation or is within Class 1 limits. External safety agencies have reviewed these products and have obtained approvals to the latest standards as they apply to this product type.

Spectra Logic QIP and RIM Controllers

The optical transceiver is a Class 1 Laser Product as defined by the international standard IEC 60825-1:1993+A1:1997+A2:2001 and by USA regulations for Class 1 products per CDRH 21 CFR 1040.10 and 1040.11. Laser emissions from Class 1 laser products are not considered hazardous when operated according to product specifications. Operating the product with a power supply voltage exceeding 4.0 volts may compromise the reliability of the product, and could result in laser emissions exceeding Class 1 limits.

NEMKO ACCREDITATION

The safety issues of this information technology equipment type have been evaluated by a government-accredited European third-party organization, such as Nemko.

This Mass Storage Device has been evaluated and determined to comply with the Safety Requirements of the International Standard for Information Technology Equipment, IEC/EN 60950-1, Second Edition. The evaluation was conducted by Nemko. Nemko participates in the CB Scheme as a National Certification Body certified by the IECEE.

ENVIRONMENTAL REGULATIONS

The Spectra T950 library complies with the following domestic and international environmental regulations and directives.

Waste of Electronic and Electrical Equipment (WEEE) Directive

Note: For information on recycling your Spectra library, please check the Spectra Logic website. European Union users should contact their local waste administration for WEEE collection instructions for this product.

The WEEE symbol on the back of this product indicates that this product meets the European Directive 2012/19/EU on Waste Electrical and Electronic Equipment, known as the WEEE directive. This directive, only applicable in European Union countries, indicates that this product should not be disposed of with normal unsorted municipal waste.

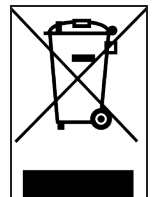

Within participating European Union countries, special collection, recycling, and disposal arrangements have been established for this product. At the end of life, the product user should dispose of this product using special WEEE collection systems. These special systems mitigate the potential effects on the environment and human health that can result from hazardous substances that may be contained in this product.

Restriction of Hazardous Substances in Electrical and Electronic Equipment (RoHS)

The RoHS marking indicates that this product is in compliance with European Council Directive 2011/65/EU RoHS, on the restriction of the use of certain hazardous substances in electrical and electronic equipment.



Measures for the Administration of the Control of Pollution by Electronic Information Products (China)



| | T950 有毒和有害物质及元素 | | | | | |
|--------------------|------------------|-----------|----------------|-----------------|---------------|-----------------|
| | 铅 (Pb) | 汞 (Hg) | 镉 (Cd) | 六价铬 (Cr(VI)) | 多溴联苯 (PBB) | 多溴联苯醚 (PBDE) |
| 磁带库 | X ¹ | O | X ² | O | O | O |
| 磁带驱动器 IBM LTO-3 | X ^{1,4} | O | O | O | O | O |
| 磁带驱动器 IBM LTO-4 | X ^{1,8} | O | O | O | O | O |
| 磁带驱动器 IBM LTO-5 | X ¹ | O | O | O | O | O |
| 摄像机 Camera | X | O | O | O | O | O |

1. 电路板焊料含有铅。服务器，存储器和存储阵列系统，用于转接、信号和传输的网络基础设施设备，以及电信网络管理设备的焊料都含有铅。
2. 电气触点和镉镀层，不包括 76/769/ECC 指令的修订指令 91/338/EE 所禁止的应用，此等指令对某些危险物质的营销和使用列有若干限制条款。
3. 柔性电缆含有十溴联苯醚 (Deca-PBDE)。若干聚合物应用的 Deca-PBDE 用量超过最大浓度限定值 (MCV)。
4. 铅含量可能高达 3.2 克。
5. 钢材中的铅含量为 0.35%，铝合金中为 0.4%，青铜等铜合金中为 4.0%。
6. 电子陶瓷零件 (例如压电式装置) 可能含有铅。
7. 电子部件可能含有铅玻璃。
8. 铅含量可能高达 5.0 克。

Recycling Your Library

For information on recycling your Spectra library, check the Spectra Logic website at: spectralogic.com/environment.

CONFLICT MINERALS POLICY

Spectra Logic is committed to complying with the OECD Due Diligence Guidance for Responsible Supply Chains of Minerals from Conflict-Affected and High-Risk Areas, as well as the applicable requirements of Section 1502 of the Dodd-Frank Act, which aims to prevent the use of minerals that directly or indirectly finance or benefit armed groups in the Democratic Republic of the Congo (DRC) or in adjoining countries (“conflict minerals”).

Affected suppliers to Spectra Logic will be required to commit to being or becoming “conflict-free” (which means that such supplier does not source conflict minerals) and sourcing, where possible, only from conflict-free smelters. Each affected supplier to Spectra Logic will be required to provide completed EICC-GeSI declarations evidencing such supplier's commitment to becoming conflict-free and documenting countries of origin for the tin, tantalum, tungsten, and gold that it purchases.

Contact Spectra Logic for more information.